

Koyo®

JTEKT
Koyo | TOYODA

LARGE SIZE BALL & ROLLER BEARINGS

General Bearings

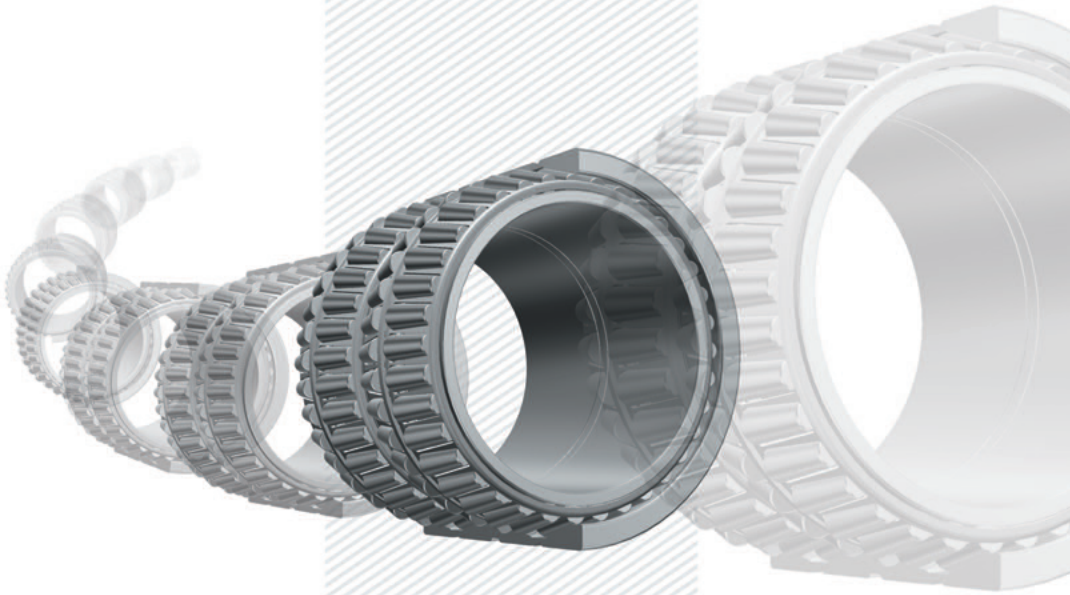

JTEKT

JTEKT CORPORATION

CAT. NO. B2002E-2

1 Selection of bearing dimensions ... 4	3 Bearing fits 35	5 Lubrication 56	7 Examples of failures 70
2 Bearing tolerances 17	4 Internal clearance 47	6 Bearing materials 66	

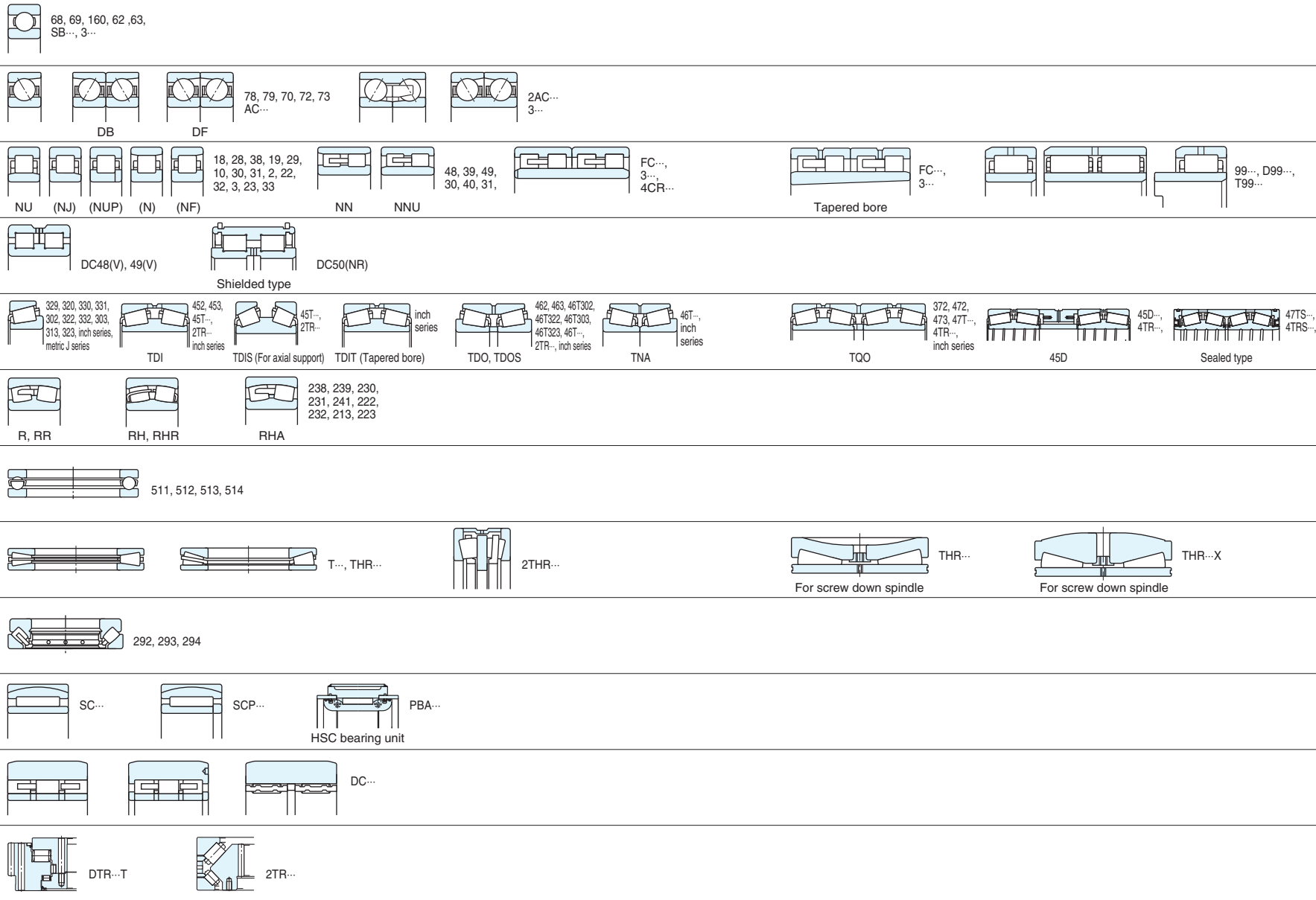

- Other products 466
- Supplementary table 476

Technical data

Bearing specification tables

- Deep groove ball bearings
- Angular contact ball bearings
- Cylindrical roller bearings
- Full complement cylindrical roller bearings for crane sheaves
- Tapered roller bearings
- Spherical roller bearings
- Thrust ball bearings
- Tapered roller thrust bearings
- Spherical thrust roller bearings
- Bearings for continuous casting machines
- Cylindrical roller bearings for the backing shafts of multi-roll mills
- Slewing rim bearings for tunnel-boring machine

Other products
Supplementary table

Koyo®

LARGE SIZE BALL & ROLLER BEARINGS

CAT. NO. B2002E-2

Value & Technology

**Publication of
LARGE SIZE BALL & ROLLER BEARINGS**

We are pleased to offer you this newly issued Koyo large size rolling bearing catalogue.

The conventional large size rolling bearing catalogue has been thoroughly revised. This catalogue includes information such as the latest bearing types, bearing numbers, and technical data.

We are confident that this catalogue will help every people engaged in design and maintenance of machinery.

This catalogue also shows bearings intended for special purposes. If you have any inquiry for selection of bearings, please contact JTEKT. We are grateful for your patronage and look forward to continuing to serve you in the future.

★ The contents of this catalog are subject to change without prior notice. Every possible effort has been made to ensure that the data herein is correct; however, JTEKT cannot assume responsibility for any errors or omissions.

Reproduction of this catalog without written consent is strictly prohibited

This publication was made using recycled paper for the protection of forests.

Technical data

- 1** Selection of bearing dimensions 4
- 2** Bearing tolerances 17
- 3** Bearing fits 35
- 4** Internal clearance 47

Bearing specification tables

- **Deep groove ball bearings** **88**
 - Single-row 90
- **Angular contact ball bearings** **100**
 - Single-row and Matched pair..... 104
 - Double-row..... 116
- **Cylindrical roller bearings** **118**
 - Single-row 124
 - Double-row..... 138
 - Four-row..... 146
 - Four-row (Tapered bore)..... 172
- **Wide series cylindrical roller bearings** .. **174**
- **Full complement cylindrical roller bearings for crane sheaves** **180**
 - Double-row, open type..... 182
 - Double-row, shielded type..... 186
- **Tapered roller bearings** **190**
 - Single-row 196
 - Double-row (Face to face ... TDI type) 234
 - Double-row (Face to face, For axial support ... TDIS type) 254
 - Double-row (Face to face, Tapered bore ... TDIT type) 264
 - Double-row (Back to back ... TDO, TDOS type) .. 268
 - Double-row (Back to back ... TNA type) 314

Other products

- Spherical roller bearing for wind turbine generator main shaft..... 466
- Back-up roll units for hot leveler..... 467
- Back-up roll units for tension leveler 468
- Ladder bearing for converter..... 470
- Trunnion split bearing for converter 471
- Sealed bearing for sintered equipment 472
- Spherical roller bearings for shaker screens... 473
- Regrinding jigs for bearings for backing shafts ... 474
- Oil / air lubricator for steel making and rolling equipment..... 475

- 5** Lubrication 56
- 6** Bearing materials 66
- 7** Examples of failures 70

- Four-row (TQO type) 318
- Four-row (45D type) 352
- Four-row (Sealed type) 356
- **Spherical roller bearings**..... **370**
- **Thrust ball bearings** **400**
 - Single-row..... 402
- **Tapered roller thrust bearings**..... **406**
 - Single-row 410
 - Double-row..... 414
 - Single-row (Screw down spindle...THR...type) 418
 - Single-row (Screw down spindle...THR...X type) .. 420
- **Spherical thrust roller bearings** ... **424**
- **Bearings for continuous casting machines** .. **434**
 - SC · SCP bearings 436
 - HSC bearing unit 442
- **Cylindrical roller bearings for the backing shafts of multi-roll mills** **448**
- **Slewing rim bearings for tunnel-boring machine**.... **454**
 - Tripel-row combined roller type (DTR...T type) 456
 - Tripel-row combined roller type (SP/DTR...T type) .. 462
 - Double-row tapered roller type (2TR...type) 464

Supplementary table

- SI units and conversion factors..... 476
- Inch/millimeter conversion 479
- Steel hardness conversion 480
- Viscosity conversion 481
- Shaft tolerances (deviation from nominal dimensions) 482
- Housing bore tolerances (deviation from nominal dimensions) 484

1. Selection of bearing dimensions

1-1 Bearing service life

When bearings rotate under load, material flakes from the surfaces of inner and outer rings or rolling elements by fatigue arising from repeated contact stress.

This phenomenon is called flaking. The total number of bearing rotations until flaking occurs is regarded as the bearing "(fatigue) service life". "Fatigue" service life" differs greatly depending upon bearing structures, dimensions, materials, and processing methods.

Since this phenomenon results from fatigue distribution in bearing materials themselves, differences in bearing service life should be statistically considered.

When a group of identical bearings are rotated under the same conditions, the total number of revolutions until 90 % of the bearings are left without flaking (i.e. a service life of 90 % reliability) is defined as the basic rating life. In operation at a constant speed, the basic rating life can be expressed in terms of time.

In actual operation, a bearing fails not only because of fatigue, but other factors as well, such as wear, seizure, creep, fretting, brinelling, cracking etc.

These bearing failures can be minimized by selecting the proper mounting method and lubricant, as well as the bearing most suitable for the application.

1-2 Calculation of service life

1-2-1 Basic dynamic load rating

The basic dynamic load rating (C) is either pure radial (for radial bearings) or central axial load (for thrust bearings) of constant magnitude in a constant direction, under which the basic rating life of 1 million revolutions can be obtained, when the inner ring rotates while the outer ring is stationary, or vice versa. The basic dynamic load rating, which represents the capacity of a bearing under rolling fatigue, is specified as the **basic dynamic radial load rating (C_r) for radial bearings, and basic dynamic axial load rating (C_a) for thrust bearings**. These load ratings are listed in the specification table.

These values are prescribed by ISO 281/1990, and are subject to change by conformance to the latest ISO standards.

1-2-2 Basic rating life

The basic rating life in relation to the basic dynamic load rating and dynamic equivalent load can be expressed using equation (1-1).

It is convenient to express the basic rating life in terms of time, using equation (1-2), when a bearing is used for operation at a constant speed.

$$\left(\begin{matrix} \text{Total} \\ \text{revolutions} \end{matrix} \right) L_{10} = \left(\frac{C}{P} \right)^p \dots\dots\dots(1-1)$$

$$\left(\begin{matrix} \text{Time} \end{matrix} \right) L_{10h} = \frac{10^6}{60n} \left(\frac{C}{P} \right)^p \dots\dots\dots(1-2)$$

where :

- L_{10} : basic rating life 10^6 revolutions
- L_{10h} : basic rating life h
- P : dynamic equivalent load N
-(refer to page 12)
- C : basic dynamic load rating N
- n : rotational speed min^{-1}
- p : for ball bearings $p = 3$
- for roller bearings $p = 10/3$

Accordingly, where the dynamic equivalent load is P , and rotational speed is n , equation (1-3) can be used to calculate the basic dynamic load rating C ; the bearing size most suitable for a specified purpose can then be selected, referring to the bearing specification table.

$$C = P \left(L_{10h} \times \frac{60n}{10^6} \right)^{1/p} \dots\dots\dots(1-3)$$

[Reference]

The equations using a service life coefficient (f_h) and rotational speed coefficient (f_n) respectively, based on equation (1-2), are as follows :

$$L_{10h} = 500 f_h^p \dots\dots\dots(1-4)$$

Coefficient of service life :

$$f_h = f_n \frac{C}{P} \dots\dots\dots(1-5)$$

Coefficient of rotational speed :

$$f_n = \left(\frac{10^6}{500 \times 60n} \right)^{1/p}$$

$$= (0.03n)^{-1/p} \dots\dots\dots(1-6)$$

For reference, the values of f_n , f_h , and L_{10h} can be easily obtained by employing the nomograph attached to this catalog, as an abbreviated method.

[Ball bearing]

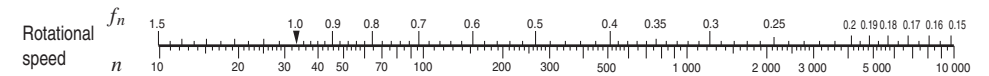

[Roller bearing]

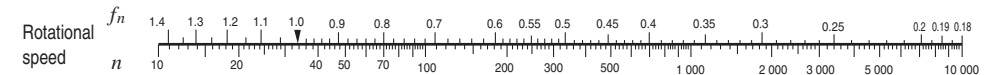

[Reference] Rotational speed (n) and its coefficients (f_n), and service life coefficient (f_h) and basic rating life (L_{10h})

1. Selection of bearing dimensions

1-2-3 Correction of basic dynamic load rating for high temperature use and dimension stabilizing treatment

In high temperature operation, bearing material hardness deteriorates, as material compositions are altered. As a result, the basic dynamic load rating is diminished. Once altered, material composition is not recovered, even if operating temperatures return to normal.

Therefore, for bearings used in high temperature operation, the basic dynamic load rating should be corrected by multiplying the basic dynamic load rating values specified in the bearing specification table by the temperature coefficient values in Table 1-1.

Table 1-1 Temperature coefficient values

Bearing temperature, °C	125	150	175	200	250
Temperature coefficient	1	1	0.95	0.90	0.75

Since normal heat treatment is not effective in maintaining the original bearing size in extended operation at 120 °C or higher, dimension stabilizing treatment is necessary. Dimension stabilizing treatment codes and their effective temperature ranges are described in Table 1-2.

Since dimension stabilizing treatment diminishes material hardness, the basic dynamic load rating may be reduced for some types of bearings.

Table 1-2 Dimension stabilizing treatment

Dimension stabilizing treatment code	Effective temperature range
S0	Over 100 °C, up to 150 °C
S1	150 °C 200 °C
S2	200 °C 250 °C

1-2-4 Modified rating life L_{nm}

The life of rolling bearings was standardized as a basic rating life in the 1960s, but in actual applications, sometimes the actual life and the basic rating life have been quite different due to the lubrication status and the influence of the usage environment. To make the calculated life closer to the actual life, a corrected rating life has been considered since the 1980s. In this corrected rating life, bearing characteristic factor a_2 (a correction factor for the case in which the characteristics related to the life are changed due to the bearing materials, manufacturing process, and design) and usage condition factor a_3 (a correction factor that takes into account usage conditions that have a direct influence on the bearing life, such as the lubrication) or factor a_{23} formed from the interdependence of these two factors, are considered with the basic rating life. These factors were handled differently by each bearing manufacturer, but they have been standardized as a modified rating life in ISO 281 in 2007. In 2013, JIS B 1518 (dynamic load ratings and rating life) was amended to conform to the ISO.

The basic rating life (L_{10}) shown in equation (1-1) is the (fatigue) life with a dependability of 90 % under normal usage conditions for rolling bearings that have standard factors such as internal design, materials, and manufacturing quality. JIS B 1518:2013 specifies a calculation method based on ISO 281:2007. To calculate accurate bearing life under a variety of operating conditions, it is necessary to consider elements such as the effect of changes in factors that can be anticipated when using different reliabilities and system approaches, and interactions between factors. Therefore, the specified calculation method considers additional stress due to the lubrication status, lubricant contamination, and fatigue load limit C_u (refer to p. 9) on the inside of the bearing. The life that uses this life modification factor a_{ISO} , which considers the above factors, is called modified rating life L_{nm} and is calculated with the following equation (1-7).

$$L_{nm} = a_1 a_{ISO} L_{10} \dots\dots\dots (1-7)$$

In this equation,

- L_{nm} : Modified rating life 10^6 rotations
 (This rating life has been modified for one of or a combination of the following: reliability of 90 % or higher, fatigue load limit, special bearing characteristics, lubrication contamination, and special operating conditions.)
- L_{10} : Basic rating life 10^6 rotations (reliability: 90 %)
- a_1 : Life modification factor for reliability
 refer to section (1)
- a_{ISO} : Life modification factor
 refer to section (2)

[Remark]

When bearing dimensions are to be selected given L_{nm} greater than 90 % in reliability, the strength of shaft and housing must be considered.

(1) Life modification factor for reliability a_1

The term "reliability" is defined as "for a group of apparently identical rolling bearings, operating under the same conditions, the percentage of the group that is expected to attain or exceed a specified life" in ISO 281:2007. Values of a_1 used to calculate a modified rating life with a reliability of 90 % or higher (a failure probability of 10 % or less) are shown in Table 1-3.

Table 1-3 Life modification factor for reliability a_1

Reliability, %	L_{nm}	a_1
90	L_{10m}	1
95	L_{5m}	0.64
96	L_{4m}	0.55
97	L_{3m}	0.47
98	L_{2m}	0.37
99	L_{1m}	0.25
99.2	$L_{0.8m}$	0.22
99.4	$L_{0.6m}$	0.19
99.6	$L_{0.4m}$	0.16
99.8	$L_{0.2m}$	0.12
99.9	$L_{0.1m}$	0.093
99.92	$L_{0.08m}$	0.087
99.94	$L_{0.06m}$	0.080
99.95	$L_{0.05m}$	0.077

(Citation from JIS B 1518:2013)

(2) Life modification factor a_{ISO}

a) System approach

The various influences on bearing life are dependent on each other. The system approach of calculating the modified life has been evaluated as a practical method for determining life modification factor a_{ISO} (ref. Fig. 1-1). Life modification factor a_{ISO} is calculated with the following equation (Fig. 1-8). A diagram is available for each bearing type (radial ball bearings, radial roller bearings, thrust ball bearings, and thrust roller bearings). (Each diagram (Figs. 1-2 to 1-5) is a citation from JIS B 1518:2013.)

Note that in practical use, this is set so that life modification factor $a_{ISO} \leq 50$.

$$a_{ISO} = f \left(\frac{e_c C_u}{P}, \kappa \right) \dots\dots\dots (1-8)$$

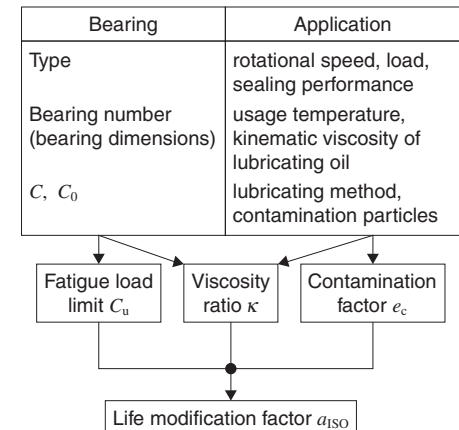

Fig. 1-1 System approach

1. Selection of bearing dimensions

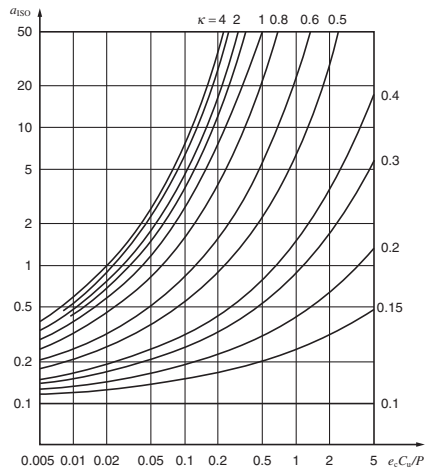

Fig. 1-2 Life modification factor a_{ISO} (Radial ball bearings)

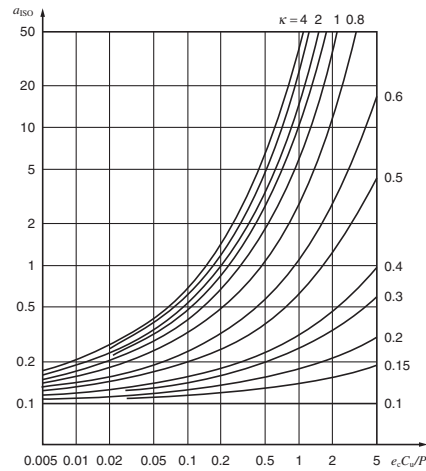

Fig. 1-3 Life modification factor a_{ISO} (Radial roller bearings)

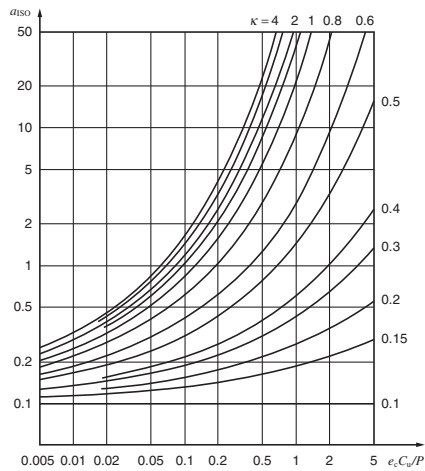

Fig. 1-4 Life modification factor a_{ISO} (Thrust ball bearings)

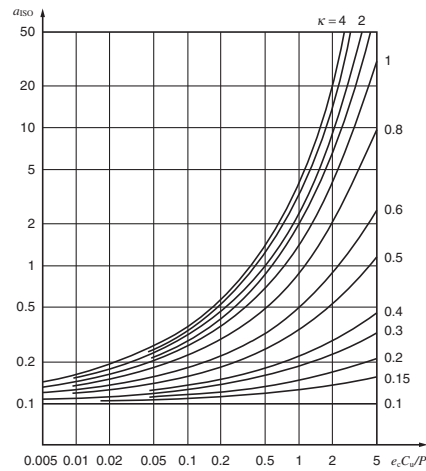

Fig. 1-5 Life modification factor a_{ISO} (Thrust roller bearings)

(Figs. 1-2 to 1-5 Citation from JIS B 1518:2013)

b) Fatigue load limit C_u

For regulated steel materials or alloy steel that has equivalent quality, the fatigue life is unlimited so long as the load condition does not exceed a certain value and so long as the lubrication conditions, lubrication cleanliness class, and other operating conditions are favorable. For general high-quality materials and bearings with high manufacturing quality, the fatigue stress limit is reached at a contact stress of approximately 1.5 GPa between the raceway and rolling elements. If one or both of the material quality and manufacturing quality are low, the fatigue stress limit will also be low.

The term “fatigue load limit” C_u is defined as “bearing load under which the fatigue stress limit is just reached in the most heavily loaded raceway contact” in ISO 281:2007, and is affected by factors such as the bearing type, size, and material.

For details on the fatigue load limits of special bearings and other bearings not listed in this catalog, contact JTEKT.

c) Contamination factor e_c

If solid particles in the contaminated lubricant are caught between the raceway and the rolling elements, indentations may form on one or both of the raceway and the rolling elements. These indentations will lead to localized increases in stress, which will decrease the life. This decrease in life attributable to the contamination of the lubricant can be calculated from the contamination level as contamination factor e_c .

D_{pw} shown in this table is the pitch diameter of ball/roller set, which is expressed simply as $D_{pw} = (D + d)/2$. (D : Outside diameter, d : Bore diameter)

For information such as details on special lubricating conditions or detailed investigations, contact JTEKT.

Table 1-4 Values of contamination factor e_c

Contamination level	e_c	
	$D_{pw} < 100 \text{ mm}$	$D_{pw} \geq 100 \text{ mm}$
Extremely high cleanliness: The size of the particles is approximately equal to the thickness of the lubricant oil film, this is found in laboratory-level environments.	1	1
High cleanliness: The oil has been filtered by an extremely fine filter, this is found with standard grease-packed bearings and sealed bearings.	0.8 to 0.6	0.9 to 0.8
Standard cleanliness: The oil has been filtered by a fine filter, this is found with standard grease-packed bearings and shielded bearings.	0.6 to 0.5	0.8 to 0.6
Minimal contamination: The lubricant is slightly contaminated.	0.5 to 0.3	0.6 to 0.4
Normal contamination: This is found when no seal is used and a coarse filter is used in an environment in which wear debris and particles from the surrounding area penetrate into the lubricant.	0.3 to 0.1	0.4 to 0.2
High contamination: This is found when the surrounding environment is considerably contaminated and the bearing sealing is insufficient.	0.1 to 0	0.1 to 0
Extremely high contamination	0	0

(Table 1-4 Citation from JIS B 1518:2013)

1. Selection of bearing dimensions

d) Viscosity ratio κ

The lubricant forms an oil film on the roller contact surface, which separates the raceway and the rolling elements. The status of the lubricant oil film is expressed by viscosity ratio κ ; the actual kinematic viscosity at the operating temperature ν divided by the reference kinematic viscosity ν_1 as shown in the following equation.

A κ greater than 4, equal to 4, or less than 0.1 is not applicable.

For details on lubricants such as grease and lubricants with extreme pressure additives, contact JTEKT.

$$\kappa = \frac{\nu}{\nu_1} \dots\dots\dots (1-9)$$

ν : Actual kinematic viscosity at the operating temperature; the viscosity of the lubricant at the operating temperature (refer to Fig. 5-3, page 65)

ν_1 : Reference kinematic viscosity; determined according to the speed and pitch diameter of ball/roller set D_{pw} of the bearing (ref. Fig. 1-6)

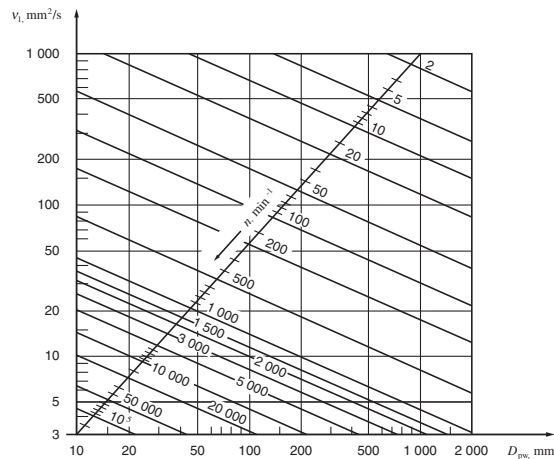

(Fig. 1-6 Citation from JIS B 1518:2013)

Fig. 1-6 Reference kinematic viscosity ν_1

1-3 Calculation of loads

Loads affecting bearings includes force exerted by the weight of the object the bearings support, transmission force of devices such as gears and belts, loads generated in equipment during operation etc.

Seldom can these kinds of load be determined by simple calculation, because the load is not always constant.

In many cases, the load fluctuates, and it is difficult to determine the frequency and magnitude of the fluctuation.

Therefore, loads are normally obtained by multiplying theoretical values with various coefficients obtained empirically.

1-3-1 Load coefficient

Even if radial and axial loads are obtained through general dynamic calculation, the actual load becomes greater than the calculated value due to vibration and impact during operation.

In many cases, the load is obtained by multiplying theoretical values by the load coefficient as shown below.

$$F = f_w \cdot F_c \dots\dots\dots (1-10)$$

where :
 F : actual load N
 F_c : calculated load N
 f_w : load coefficient (refer to Table 1-5)

Table 1-5 Load coefficient f_w

Operating condition	Application example	f_w
Operation with little vibration or impact	Motors Machine tools Measuring instrument	1.0 - 1.2
Normal operation (slight impact)	Railway rolling stock Automobiles Paper manufacturing equipment Air blowers Compressors Agricultural equipment	1.2 - 2.0
Operation with severe vibration or impact	Rolling mills Crushers Construction equipment Shaker screens	2.0 - 3.0

1. Selection of bearing dimensions

1-4 Dynamic equivalent load

Bearings are used under various operating conditions; however, in most cases, bearings receive radial and axial load combined, while the load magnitude fluctuates during operation.

Therefore, it is impossible to directly compare the actual load and basic dynamic load rating.

The two are compared by replacing the loads applied to the shaft center with one of a constant magnitude and in a specific direction, that yields the same bearing service life as under actual load and rotational speed.

This theoretical load is referred to as the dynamic equivalent load (P).

1-4-1 Calculation of dynamic equivalent load

Dynamic equivalent loads for radial bearings and thrust bearings ($\alpha \neq 90^\circ$) which receive a combined load of a constant magnitude in a specific direction can be calculated using the following equation.

$$P = XF_r + YF_a \dots\dots\dots (1-11)$$

where :

- P : dynamic equivalent load N
 - P_r : dynamic equivalent radial load (for radial bearings, N)
 - P_a : dynamic equivalent axial load (for thrust bearings, N)
 - F_r : radial load N
 - F_a : axial load N
 - X : radial load factor
 - Y : axial load factor
- (values of X and Y are listed in the bearing specification table.)

■ When $F_a/F_r \leq e$ for single-row radial bearings, it is taken that $X = 1$, and $Y = 0$. Hence, the dynamic equivalent load rating is $P_r = F_r$.

(Values of e , which designates the limit of F_a/F_r , are listed in the bearing specification table.)

■ For single-row angular contact ball bearings and tapered roller bearings, axial component forces (F_{ac}) are generated as shown in Fig. 1-7, therefore a pair of bearings is arranged face-to-face or back-to-back.

The axial component force can be calculated using the following equation.

$$F_{ac} = \frac{F_r}{2Y} \dots\dots\dots (1-12)$$

Table 1-6 describes the calculation of the dynamic equivalent load when radial loads and external axial loads (K_a) are applied to bearings.

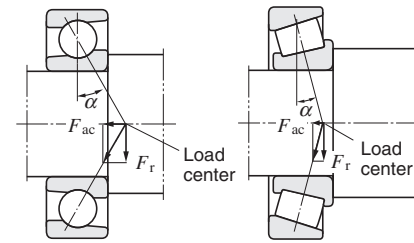

(Load center position is listed in the bearing specification table.)

Fig. 1-7 Axial component force

■ For thrust ball bearings with contact angle $\alpha = 90^\circ$, to which an axial load is applied, $P_a = F_a$.

■ The dynamic equivalent load of spherical thrust roller bearing can be calculated using the following equation.

$$P_a = F_a + 1.2F_r \dots\dots\dots (1-13)$$

where : $F_r/F_a \leq 0.55$

Table 1-6 Dynamic equivalent load calculation : when a pair of single-row angular contact ball bearings or tapered roller bearings is arranged face-to-face or back-to-back.

Paired mounting		Loading condition	Bearing	Axial load	Dynamic equivalent load
Back-to-back arrangement	Face-to-face arrangement				
		$\frac{F_{rB}}{2Y_B} + K_a \geq \frac{F_{rA}}{2Y_A}$	Bearing A	$\frac{F_{rB}}{2Y_B} + K_a$	$P_A = XF_{rA} + Y_A \left(\frac{F_{rB}}{2Y_B} + K_a \right)$ $P_A = F_{rA}$, where $P_A < F_{rA}$
			Bearing B	-	$P_B = F_{rB}$
		$\frac{F_{rB}}{2Y_B} + K_a < \frac{F_{rA}}{2Y_A}$	Bearing A	-	$P_A = F_{rA}$
			Bearing B	$\frac{F_{rA}}{2Y_A} - K_a$	$P_B = XF_{rB} + Y_B \left(\frac{F_{rA}}{2Y_A} - K_a \right)$ $P_B = F_{rB}$, where $P_B < F_{rB}$
		$\frac{F_{rB}}{2Y_B} \leq \frac{F_{rA}}{2Y_A} + K_a$	Bearing A	-	$P_A = F_{rA}$
			Bearing B	$\frac{F_{rA}}{2Y_A} + K_a$	$P_B = XF_{rB} + Y_B \left(\frac{F_{rA}}{2Y_A} + K_a \right)$ $P_B = F_{rB}$, where $P_B < F_{rB}$
		$\frac{F_{rB}}{2Y_B} > \frac{F_{rA}}{2Y_A} + K_a$	Bearing A	$\frac{F_{rB}}{2Y_B} - K_a$	$P_A = XF_{rA} + Y_A \left(\frac{F_{rB}}{2Y_B} - K_a \right)$ $P_A = F_{rA}$, where $P_A < F_{rA}$
			Bearing B	-	$P_B = F_{rB}$

[Remarks] 1. These equations can be used when internal clearance and preload during operation are zero.
2. Radial load is treated as positive in the calculation, if it is applied in a direction opposite that shown in Fig. in Table 1-6.

1. Selection of bearing dimensions

1-4-2 Mean dynamic equivalent load

When load magnitude or direction varies, it is necessary to calculate the mean dynamic equivalent load, which provides the same length

of bearing service life as that under the actual load fluctuation.

The mean dynamic equivalent load (P_m) under different load fluctuations is described using Graphs (1) to (4).

(1) Staged fluctuation	(2) Stageless fluctuation
$P_m = \sqrt[p]{\frac{P_1^p n_1 t_1 + P_2^p n_2 t_2 + \dots + P_n^p n_n t_n}{n_1 t_1 + n_2 t_2 + \dots + n_n t_n}} \dots\dots\dots (1-14)$	$P_m = \frac{P_{\min} + 2 P_{\max}}{3} \dots\dots\dots (1-15)$
(3) Fluctuation forming sine curve	(4) Fluctuation forming sine curve (upper half of sine curve)
$P_m = 0.68 P_{\max} \dots\dots\dots (1-16)$	$P_m = 0.75 P_{\max} \dots\dots\dots (1-17)$

Symbols for Graphs (1) to (4)

P_m : mean dynamic equivalent load	N
P_1 : dynamic equivalent load applied for t_1 hours at rotational speed n_1	N
P_2 : dynamic equivalent load applied for t_2 hours at rotational speed n_2	N
⋮	⋮
P_n : dynamic equivalent load applied for t_n hours at rotational speed n_n	N
P_{\min} : minimum dynamic equivalent load	N
P_{\max} : maximum dynamic equivalent load	N
$\Sigma n_i t_i$: total rotation in (t_1 to t_i) hours	
p : for ball bearings $p = 3$	
for roller bearings $p = 10/3$	

[Reference] Mean rotational speed n_m can be calculated using the following equation :

$$n_m = \frac{n_1 t_1 + n_2 t_2 + \dots + n_n t_n}{t_1 + t_2 + \dots + t_n}$$

1-5 Basic static load rating and static equivalent load

1-5-1 Basic static load rating

Excessive static load or impact load even at very low rotation causes partial permanent deformation of the rolling element and raceway contacting surfaces. This permanent deformation increases with the load; if it exceeds a certain limit, smooth rotation will be hindered.

The basic static load rating is the static load which responds to the calculated contact stress shown below, at the contact center between the raceway and rolling elements which receive the maximum load.

- Self-aligning ball bearings ... 4 600 MPa
- Other ball bearings 4 200 MPa
- Roller bearings 4 000 MPa

The total extent of contact stress-caused permanent deformation on surfaces of rolling elements and raceway will be approximately 0.000 1 times greater than the rolling element diameter.

The basic static load rating for radial bearings is specified as **the basic static radial load rating**, and for thrust bearings, as **the basic static axial load rating**. These load ratings are listed in the bearing specification table, using C_{0r} and C_{0a} respectively.

These values are prescribed by ISO 78/1987 and are subject to change by conformance to the latest ISO standards.

1-5-2 Static equivalent load

The static equivalent load is a theoretical load calculated such that, during rotation at very low speed or when bearings are stationary, the same contact stress as that imposed under actual loading condition is generated at the contact center between raceway and rolling element to which the maximum load is applied.

For radial bearings, radial load passing through the bearing center is used for the calculation; for thrust bearings, axial load in a direction along the bearing axis is used.

The static equivalent load can be calculated using the following equations.

[Radial bearings]

...The greater value obtained by the following two equations is used.

$$P_{0r} = X_0 F_r + Y_0 F_a \dots\dots\dots (1-18)$$

$$P_{0r} = F_r \dots\dots\dots (1-19)$$

[Thrust bearings]

($\alpha \neq 90^\circ$)

$$P_{0a} = X_0 F_r + F_a \dots\dots\dots (1-20)$$

[When $F_a < X_0 F_r$, the solution becomes less accurate.]

($\alpha = 90^\circ$)

$$P_{0a} = F_a \dots\dots\dots (1-21)$$

where :

- P_{0r} : static equivalent radial load N
- P_{0a} : static equivalent axial load N
- F_r : radial load N
- F_a : axial load N
- X_0 : static radial load factor
- Y_0 : static axial load factor
- (values of X_0 and Y_0 are listed in the bearing specification table.)

1. Selection of bearing dimensions

1-5-3 Safety coefficient

The allowable static equivalent load for a bearing is determined by the basic static load rating of the bearing; however, bearing service life, which is affected by permanent deformation, differs in accordance with the performance required of the bearing and operating conditions.

Therefore, a safety coefficient is designated, based on empirical data, so as to ensure safety in relation to basic static load rating.

$$f_s = \frac{C_0}{P_0} \dots\dots\dots (1-22)$$

where :
 f_s : safety coefficient (ref. Table 1-7)
 C_0 : basic static load rating N
 P_0 : static equivalent load N

Table 1-7 Values of safety coefficient f_s

Operating condition		f_s (min.)	
		Ball bearing	Roller bearing
With bearing rotation	When high running accuracy is required	2	3
	Normal operation	1	1.5
	When impact load is applied	1.5	3
Without bearing rotation (occasional oscillation)	Normal operation	0.5	1
	When impact load or uneven distribution load is applied	1	2

[Remark] For spherical thrust roller bearings, $f_s \geq 4$.

2. Bearing tolerances

Bearing tolerances and permissible values for the boundary dimensions and running accuracy of bearings are specified. These values are prescribed in JIS, ISO, ABMA, etc.

Bearing tolerances are classified into 6, 5, 4 etc., other than ordinary class 0. Class 0 bearings offer adequate performance for general applications, and bearings of class 5, 4, or higher are required for machine tools.

Table 2-1 shows the tolerance classes and JTEKT codes applied to the types of bearings shown in the dimensional tables.

Bearing tolerances of these bearings are shown in Tables 2-2 through 2-8. Table 2-9 shows the allowable limited values of chamfer dimensions, and Table 2-10 includes the tolerances for tapered bore.

Table 2-1 Tolerance class for each bearing type

Bearing type		Applied standards of tolerance class				Applied tolerance table
Deep groove ball bearing		JIS class 0	JIS class 6	JIS class 5	(JIS class 4)	Table 2-2
Angular contact ball bearing		JIS class 0	JIS class 6	JIS class 5	(JIS class 4)	
Cylindrical roller bearing		JIS class 0	JIS class 6	JIS class 5	(JIS class 4)	
Wide series cylindrical roller bearing		Equivalent to class 0	Equivalent to class 6	—	—	
Full complement cylindrical roller bearing		Equivalent to class 0	Equivalent to class 6	—	—	
Tapered roller bearing	Metric series (single-row)	JIS class 0, 6X	JIS class 6	JIS class 5	(JIS class 4)	Table 2-3
	Metric series (double or four-row)	BAS class 0	—	—	—	Table 2-4
	Metric series (J-series)	Class PK	Class PN	Class PC	(Class PB)	Table 2-6
	Inch series	ABMA Class 4	ABMA Class 2	ABMA Class 3	(ABMA Class 0)	Table 2-5
Spherical roller bearing		JIS class 0	—	—	—	Table 2-2
Thrust ball bearing		JIS class 0	JIS class 6	(JIS class 5)	—	Table 2-7
Metric series tapered roller thrust bearing		Equivalent to class 0	—	—	—	Table 2-8
Spherical thrust roller bearing		JIS class 0	—	—	—	

[Remarks] 1. Products of tolerance classes included in parentheses shown in the table above are required, contact JTEKT.
 2. Thrust tapered roller bearings for screw down, cylindrical roller bearings for multistage rolling mill back-up roll, and bearings for tunneling machine are manufactured with the special tolerances appropriate for their operating conditions.

2. Bearing tolerances

Table 2-2 (1) Radial bearing tolerances (tapered roller bearings excluded) = JIS B 1514 =

(1) Inner ring (bore diameter)

Unit : μm

Nominal bore diameter d mm		Single plane mean bore diameter deviation								Single bore diameter deviation $\Delta_{ds}^{(1)}$	Single plane bore diameter variation V_{dsp}								Mean bore diameter variation				Nominal bore diameter d mm						
		Δ_{dmp}									Diameter series 7, 8, 9				Diameter series 0, 1				Diameter series 2, 3, 4										
		class 0		class 6		class 5		class 4			class 4		class 0		class 6		class 5		class 4		class 0				class 6		class 5		class 4
over	up to	upper	lower	upper	lower	upper	lower	upper	lower	upper	lower	max.				max.				max.				over	up to				
30	50	0	-12	0	-10	0	-8	0	-6	0	-6	15	13	8	6	12	10	6	5	9	8	6	5	9	8	4	3	30	50
50	80	0	-15	0	-12	0	-9	0	-7	0	-7	19	15	9	7	19	15	7	5	11	9	7	5	11	9	5	3.5	50	80
80	120	0	-20	0	-15	0	-10	0	-8	0	-8	25	19	10	8	25	19	8	6	15	11	8	6	15	11	5	4	80	120
120	150	0	-25	0	-18	0	-13	0	-10	0	-10	31	23	13	10	31	23	10	8	19	14	10	8	19	14	7	5	120	150
150	180	0	-25	0	-18	0	-13	0	-10	0	-10	31	23	13	10	31	23	10	8	19	14	10	8	19	14	7	5	150	180
180	250	0	-30	0	-22	0	-15	0	-12	0	-12	38	28	15	12	38	28	12	9	23	17	12	9	23	17	8	6	180	250
250	315	0	-35	0	-25	0	-18	0	-15	0	-15	44	31	18	15	44	31	14	11	26	19	14	11	26	19	9	8	250	315
315	400	0	-40	0	-30	0	-23	0	-18	0	-18	50	38	23	18	50	38	18	14	30	23	18	14	30	23	12	9	315	400
400	500	0	-45	0	-35	0	-28	0	-23	0	-23	56	44	28	23	56	44	21	17	34	26	21	17	34	26	14	12	400	500
500	630	0	-50	0	-40	0	-35	-	-	-	-	63	50	35	-	63	50	26	-	38	30	26	-	38	30	18	-	500	630
630	800	0	-75	0	-50	0	-45	-	-	-	-	94	63	45	-	94	63	34	-	56	38	34	-	56	38	23	-	630	800
800	1 000	0	-100	0	-60	0	-60	-	-	-	-	125	75	60	-	125	75	45	-	75	45	45	-	75	45	30	-	800	1 000
1 000	1 250	0	-125	0	-75	0	-75	-	-	-	-	156	94	75	-	156	94	56	-	94	56	56	-	94	56	38	-	1 000	1 250
1 250	1 600	0	-160	-	-	-	-	-	-	-	-	200	-	-	-	200	-	-	-	120	-	-	-	120	-	-	-	1 250	1 600
1 600	2 000	0	-200	-	-	-	-	-	-	-	-	250	-	-	-	250	-	-	-	150	-	-	-	150	-	-	-	1 600	2 000

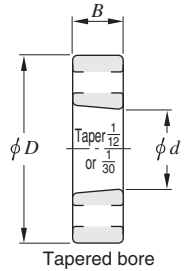
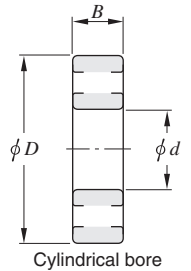

(2) Inner ring (running accuracy and width)

Unit : μm

Nominal bore diameter d mm		Radial runout of assembled bearing inner ring K_{ia}				S_d				$S_{ia}^{(2)}$				Single inner ring width deviation Δ_{Bs}								Matched pair inner ring width deviation $\Delta_{Bs}^{(3)}$								Inner ring width variation V_{Bs}				Nominal bore diameter d mm	
		class 0 class 6 class 5 class 4				class 5 class 4 class 5 class 4				class 0 class 6 class 5 class 4				class 4 class 0 ⁽⁴⁾ class 6 ⁽⁴⁾ class 5 ⁽⁴⁾ class 4				class 0 class 6 class 5 class 4																	
		max.				max.				max.				upper lower upper lower upper lower upper lower				upper lower upper lower upper lower upper lower upper lower				max.													
over	up to	upper	lower	upper	lower	upper	lower	upper	lower	upper	lower	upper	lower	upper	lower	upper	lower	upper	lower	upper	lower	upper	lower	upper	lower	upper	lower	over	up to						
30	50	15	10	5	4	8	4	8	4	0	-120	0	-120	0	-120	0	-120	0	-250	0	-250	0	-250	0	-250	20	20	5	3	30	50				
50	80	20	10	5	4	8	5	8	5	0	-150	0	-150	0	-150	0	-150	0	-380	0	-380	0	-250	0	-250	25	25	6	4	50	80				
80	120	25	13	6	5	9	5	9	5	0	-200	0	-200	0	-200	0	-200	0	-380	0	-380	0	-380	0	-380	25	25	7	4	80	120				
120	150	30	18	8	6	10	6	10	7	0	-250	0	-250	0	-250	0	-250	0	-500	0	-500	0	-380	0	-380	30	30	8	5	120	150				
150	180	30	18	8	6	10	6	10	7	0	-250	0	-250	0	-250	0	-250	0	-500	0	-500	0	-380	0	-380	30	30	8	5	150	180				
180	250	40	20	10	8	11	7	13	8	0	-300	0	-300	0	-300	0	-300	0	-500	0	-500	0	-500	0	-500	30	30	10	6	180	250				
250	315	50	25	13	10	13	8	15	9	0	-350	0	-350	0	-350	0	-350	0	-500	0	-500	0	-500	-	-	35	35	13	8	250	315				
315	400	60	30	15	13	15	9	20	12	0	-400	0	-400	0	-400	0	-400	0	-630	0	-630	0	-630	-	-	40	40	15	9	315	400				
400	500	65	35	20	15	18	11	25	15	0	-450	0	-450	0	-450	0	-450	0	-	-	-	-	-	-	-	50	45	18	11	400	500				
500	630	70	40	25	-	25	-	30	-	0	-500	0	-500	0	-500	0	-500	0	-	-	-	-	-	-	-	60	50	20	-	500	630				
630	800	80	50	30	-	30	-	35	-	0	-750	0	-750	0	-750	0	-750	0	-	-	-	-	-	-	-	70	60	23	-	630	800				
800	1 000	90	60	40	-	40	-	45	-	0	-1 000	0	-1 000	0	-1 000	0	-1 000	0	-	-	-	-	-	-	-	80	60	35	-	800	1 000				
1 000	1 250	100	70	50	-	50	-	60	-	0	-1 250	0	-1 250	0	-1 250	0	-1 250	0	-	-	-	-	-	-	-	100	60	45	-	1 000	1 250				
1 250	1 600	120	-	-	-	-	-	-	-	0	-1 600	-	-	-	-	-	-	-	-	-	-	-	-	-	-	120	-	-	-	1 250	1 600				
1 600	2 000	140	-	-	-	-	-	-	-	0	-2 000	-	-	-	-	-	-	-	-	-	-	-	-	-	-	140	-	-	-	1 600	2 000				

S_d : Perpendicularity of inner ring face with respect to the bore S_{ia} : Axial runout of assembled bearing inner ring

4) Also applicable to the inner ring with tapered bore of $d \geq 50$ mm.

[Notes] 1) These shall be applied to bearings of diameter series 0, 1, 2, 3 and 4.

[Remark] Values in Italics are prescribed in JTEKT standards.

2) These shall be applied to deep groove ball bearings and angular contact ball bearings.

3) These shall be applied to individual bearing rings manufactured for matched pair or stack bearings.

2. Bearing tolerances

Table 2-2 (2) Radial bearing tolerances (tapered roller bearings excluded)
(3) Outer ring (outside diameter)

Unit : μm

Nominal outside dia. D mm		Single plane mean outside diameter deviation								Single outside diameter deviation $\Delta D_s^{(1)}$		Single plane outside diameter variation V_{Dsp}												Mean outside diameter variation				Nominal outside dia. D mm			
		ΔD_{mp}										Diameter series 7, 8, 9				Diameter series 0, 1				Diameter series 2, 3, 4				V_{Dmp}							
		class 0		class 6		class 5		class 4				class 4 ⁽⁵⁾		class 0 ⁽²⁾	class 6 ⁽²⁾	class 5 ⁽⁵⁾	class 4 ⁽⁵⁾	Class 0 ⁽²⁾	Class 6 ⁽²⁾	Class 5 ⁽⁵⁾	Class 4 ⁽⁵⁾	Class 0 ⁽²⁾	Class 6 ⁽²⁾	Class 0 ⁽²⁾	Class 6 ⁽²⁾	Class 5	Class 4				
		over	up to	upper	lower	upper	lower	upper	lower			upper	lower	max.				max.				max.				over	up to				
50	80	0	-13	0	-11	0	-9	0	-7	0	-7	16	14	9	7	13	11	7	5	10	8	7	5	20	16	10	8	5	3.5	50	80
80	120	0	-15	0	-13	0	-10	0	-8	0	-8	19	16	10	8	19	16	8	6	11	10	8	6	26	20	11	10	5	4	80	120
120	150	0	-18	0	-15	0	-11	0	-9	0	-9	23	19	11	9	23	19	8	7	14	11	8	7	30	25	14	11	6	5	120	150
150	180	0	-25	0	-18	0	-13	0	-10	0	-10	31	23	13	10	31	23	10	8	19	14	10	8	38	30	19	14	7	5	150	180
180	250	0	-30	0	-20	0	-15	0	-11	0	-11	38	25	15	11	38	25	11	8	23	15	11	8	-	-	23	15	8	6	180	250
250	315	0	-35	0	-25	0	-18	0	-13	0	-13	44	31	18	13	44	31	14	10	26	19	14	10	-	-	26	19	9	7	250	315
315	400	0	-40	0	-28	0	-20	0	-15	0	-15	50	35	20	15	50	35	15	11	30	21	15	11	-	-	30	21	10	8	315	400
400	500	0	-45	0	-33	0	-23	0	-17	0	-17	56	41	23	17	56	41	17	13	34	25	17	13	-	-	34	25	12	9	400	500
500	630	0	-50	0	-38	0	-28	0	-20	0	-20	63	48	28	20	63	48	21	15	38	29	21	15	-	-	38	29	14	10	500	630
630	800	0	-75	0	-45	0	-35	-	-	-	-	94	56	35	-	94	56	26	-	55	34	26	-	-	-	55	34	18	-	630	800
800	1 000	0	-100	0	-60	0	-50	-	-	-	-	125	75	50	-	125	75	38	-	75	45	38	-	-	-	75	45	25	-	800	1 000
1 000	1 250	0	-125	0	-75	0	-63	-	-	-	-	156	94	63	-	156	94	47	-	94	56	47	-	-	-	94	56	31	-	1 000	1 250
1 250	1 600	0	-160	0	-90	0	-80	-	-	-	-	200	113	80	-	200	113	60	-	120	68	60	-	-	-	120	68	40	-	1 250	1 600
1 600	2 000	0	-200	0	-120	0	-	-	-	-	-	250	150	-	-	250	150	-	-	150	90	-	-	-	-	150	90	-	-	1 600	2 000
2 000	2 500	0	-250	-	-	-	-	-	-	-	-	313	-	-	-	313	-	-	-	188	-	-	-	-	-	188	-	-	-	2 000	2 500

(4) Outer ring (running accuracy and width)

Unit : μm

Nominal outside dia. D mm		Radial runout of assembled bearing outer ring				$S_D^{(4)}$		$S_{ea}^{(3)(4)}$		$\Delta C_s^{(3)}$		Outer ring width variation		
		K_{ea}				class 5		class 4		classes 0, 6, 5, 4		$V_{Cs}^{(3)}$		
		class 0	class 6	class 5	class 4	class 5	class 4	class 5	class 4	classes 0, 6	class 5	class 4	max.	
over	up to	max.				max.		max.		upper	lower	max.		
50	80	25	13	8	5	8	4	10	5			6	3	
80	120	35	18	10	6	9	5	11	6			8	4	
120	150	40	20	11	7	10	5	13	7			8	5	
150	180	45	23	13	8	10	5	14	8			8	5	
180	250	50	25	15	10	11	7	15	10			10	7	
250	315	60	30	18	11	13	8	18	10			11	7	
315	400	70	35	20	13	13	10	20	13	Shall conform to the tolerance ΔB_s on d of the same bearing	Shall conform to the tolerance V_{Bs} on d of the same bearing	13	8	
400	500	80	40	23	15	15	12	23	15			15	9	
500	630	100	50	25	18	18	13	25	18			18	11	
630	800	120	60	30	-	20	-	30	-			20	-	
800	1 000	140	75	40	-	23	-	40	-			23	-	
1 000	1 250	160	85	45	-	30	-	45	-			30	-	
1 250	1 600	190	95	60	-	45	-	60	-			45	-	
1 600	2 000	220	110	-	-	-	-	-	-			-	-	
2 000	2 500	250	-	-	-	-	-	-	-			-	-	

S_D : Perpendicularity of outer ring outside surface with respect to the face

S_{ea} : Axial runout of assembled bearing outer ring

ΔC_s : Deviation of a single outer ring width

[Notes]

- 1) These shall be applied to bearings of diameter series 0, 1, 2, 3 and 4.
- 2) Shall be applied when locating snap ring is not fitted.
- 3) These shall be applied to deep groove ball bearings and angular contact ball bearings.
- 4) These shall not be applied to flanged bearings.
- 5) These shall not be applied to shielded bearings and sealed bearings.

[Remark]

Values in Italics are prescribed in JTEKT standards.

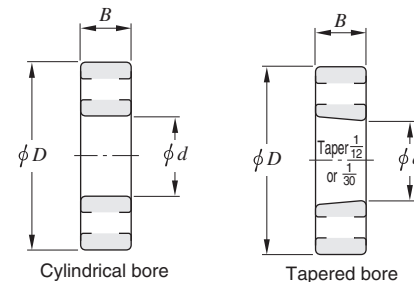

d : nominal bore diameter
 D : nominal outside diameter
 B : nominal assembled bearing width

2. Bearing tolerances

Table 2-3 (1) Tolerances for metric series tapered roller bearings = JIS B 1514 =

(1) Inner ring

Unit : μm

Nominal bore diameter d mm	Single plane mean bore diameter deviation Δ_{dmp}						Single bore diameter deviation Δ_{ds}		Single plane bore diameter variation V_{dsp}				Mean bore diameter variation V_{dmp}				Radial runout of assembled bearing inner ring K_{ia}				S_d		S_{ia}		Single inner ring width deviation Δ_{Bs}						Nominal bore diameter d mm			
	classes 0, 6X		classes 6, 5		class 4		class 4		classes 0, 6X	class 6	class 5	class 4	classes 0, 6X	class 6	class 5	class 4	classes 0, 6X	class 6	class 5	class 4	class 4	class 4	class 4	class 0	class 6X	class 6	classes 5, 4	over	up to					
	upper	lower	upper	lower	upper	lower	upper	lower	max.				max.				max.				max.		upper	lower	upper	lower	upper	lower	upper	lower	over	up to		
	over	up to																																
80	120	0	-20	0	-15 ²⁾	0	-10	0	-10	20	15	11	8	15	11	8	5	30	13	8	5	9	5	5	0	-200	0	-50	0	-200	0	-400	80	120
120	180	0	-25	0	-18 ²⁾	0	-13	0	-13	25	18	14	10	19	14	9	7	35	18	11	6	10	6	7	0	-250	0	-50	0	-250	0	-500	120	180
180	250	0	-30	0	-22 ²⁾	0	-15	0	-15	30	22	17	11	23	16	11	8	50	20	13	8	11	7	8	0	-300	0	-50	0	-300	0	-600	180	250
250	315	0	-35	0	-25	0	-18	0	-18	35	25	19	12	26	19	13	9	60	30	13	9	13	8	9	0	-350	0	-50	0	-350	0	-700	250	315
315	400	0	-40	0	-30	-	-	-	-	40	30	23	-	30	23	15	-	70	35	15	-	15	-	-	0	-400	0	-50	0	-400	0	-800 ³⁾	315	400
400	500	0	-45	0	-35	-	-	-	-	45	35	28	-	34	26	17	-	80	40	20	-	17	-	-	0	-450	0	-50	0	-450	0	-900 ³⁾	400	500
500	630	0	-60	0	-40	-	-	-	-	60	40	35	-	40	30	20	-	90	50	25	-	20	-	-	0	-500	-	-	0	-500	0	-1 100 ³⁾	500	630
630	800	0	-75	0	-50	-	-	-	-	75	50	45	-	45	38	25	-	100	60	30	-	25	-	-	0	-750	-	-	0	-750	0	-1 600 ³⁾	630	800
800	1 000	0	-100	0	-60	-	-	-	-	100	60	60	-	55	45	30	-	115	75	37	-	30	-	-	0	-1 000	-	-	0	-1 000	0	-2 000 ³⁾	800	1 000
1 000	1 250	0	-125	0	-75	-	-	-	-	125	75	56	-	94 ¹⁾	56	38	-	120 ¹⁾	85	28	-	30	-	-	0	-1 250	-	-	0	-1 250	0	-2 500 ³⁾	1 000	1 250
1 250	1 600	0	-160	0	-90	-	-	-	-	160	-	-	-	120 ¹⁾	-	-	-	120 ¹⁾	-	-	-	-	-	-	0	-1 600	-	-	-	-	-	1 250	1 600	
1 600	2 000	0	-200	-	-	-	-	-	-	200	-	-	-	150 ¹⁾	-	-	-	140 ¹⁾	-	-	-	-	-	-	0	-2 000	-	-	-	-	-	1 600	2 000	

S_d : Perpendicularity of inner ring face with respect to the bore, S_{ia} : Axial runout of assembled bearing inner ring

(2-1) Outer ring

Unit : μm

Nominal outside diameter D mm	Single plane mean outside diameter deviation Δ_{Dmp}						Single outside diameter deviation Δ_{Ds}		Single plane outside diameter variation V_{Dsp}				Mean outside diameter variation V_{Dmp}				Radial runout of assembled bearing outer ring K_{ea}				$S_D^{4)}$		$S_{ea}^{4)}$		Nominal outside diameter D mm			
	classes 0, 6X		classes 6, 5		class 4		class 4		classes 0, 6X	class 6	class 5	class 4	classes 0, 6X	class 6	class 5	class 4	classes 0, 6X	class 6	class 5	class 4	class 4	class 4	class 4	over	up to	over	up to	
	upper	lower	upper	lower	upper	lower	upper	lower	max.				max.				max.				max.		upper	lower	upper	lower	over	up to
	over	up to																										
80	120	0	-18	0	-13 ²⁾	0	-10	0	-10	18	13	10	8	14	10	7	5	35	18	10	6	9	5	6	80	120		
120	150	0	-20	0	-15 ²⁾	0	-11	0	-11	20	15	11	8	15	11	8	6	40	20	11	7	10	5	7	120	150		
150	180	0	-25	0	-18 ²⁾	0	-13	0	-13	25	18	14	10	19	14	9	7	45	23	13	8	10	5	8	150	180		
180	250	0	-30	0	-20 ²⁾	0	-15	0	-15	30	20	15	11	23	15	10	8	50	25	15	10	11	7	10	180	250		
250	315	0	-35	0	-25 ²⁾	0	-18	0	-18	35	25	19	14	26	19	13	9	60	30	18	11	13	8	10	250	315		
315	400	0	-40	0	-28 ²⁾	0	-20	0	-20	40	28	22	15	30	21	14	10	70	35	20	13	13	10	13	315	400		
400	500	0	-45	0	-33	-	-	-	-	45	33	26	-	34	25	17	-	80	40	24	-	17	-	-	400	500		
500	630	0	-50	0	-38	-	-	-	-	60	38	30	-	38	29	20	-	100	50	30	-	20	-	-	500	630		
630	800	0	-75	0	-45	-	-	-	-	80	45	38	-	55	34	25	-	120	60	36	-	25	-	-	630	800		
800	1 000	0	-100	0	-60	-	-	-	-	100	60	50	-	75	45	30	-	140	75	43	-	30	-	-	800	1 000		
1 000	1 250	0	-125	0	-80	-	-	-	-	130	75	65	-	90	56	38	-	160	85	52	-	38	-	-	1 000	1 250		
1 250	1 600	0	-160	0	-100	-	-	-	-	170	90	90	-	100	68	50	-	180	95	62	-	50	-	-	1 250	1 600		
1 600	2 000	0	-200	0	-120	-	-	-	-	200 ¹⁾	120	90	-	150 ¹⁾	90	60	-	220 ¹⁾	115	45	-	40	-	-	1 600	2 000		

- [Notes] 1) These shall be applied to bearing of tolerance class 0.
 2) These shall be applied to bearing of tolerance class 6.
 3) These shall be applied to bearing of tolerance class 5.
 4) These shall not be applied to flanged bearings.

S_D : Perpendicularity of outer ring outside surface with respect to the face
 S_{ea} : Axial runout of assembled bearing outer ring

(2-2) Outer ring Unit : μm

Nominal bore diameter d mm	Single outer ring width deviation Δ_{Cs}				
	class 6X ⁴⁾		classes 0, 6, 5, 4		
	upper	lower	upper	lower	
over	up to				
80	120	0	-100		
120	180	0	-100		
180	250	0	-100		
250	315	0	-100		
315	400	0	-100		
400	500	0	-100		
500	630	-	-		
630	800	-	-		
800	1 000	-	-		

Shall conform to the tolerance Δ_{Bs} on d of the same bearing

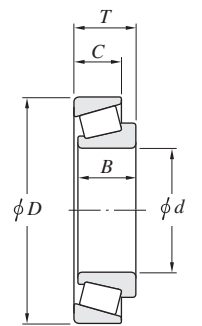

d : nominal bore diameter
 D : nominal outside diameter
 B : nominal inner ring width
 C : nominal outer ring width
 T : nominal assembled bearing width

[Remark] Values in Italics are prescribed in JTEKT standards.

2. Bearing tolerances

Table 2-3 (2) Tolerances for metric series tapered roller bearings

(3) Assembled bearing width and effective width

Unit : μm

Nominal bore diameter d mm	Actual bearing width deviation ΔT_s								Actual effective inner sub-unit width deviation ΔT_{1s}							
	class 0		class 6X		class 6		classes 5, 4		class 0		class 6X		classes 5, 4			
	upper	lower	upper	lower	upper	lower	upper	lower	upper	lower	upper	lower	upper	lower		
over 80 up to 120	+200	-200	+100	0	+200	-200	+200	-200	+100	-100	+ 50	0	+100	-100		
120 180	+350	-250	+150	0	+350	-250	+350	-250	+150	-150	+ 50	0	+150	-150		
180 250	+350	-250	+150	0	+350	-250	+350	-250	+150	-150	+ 50	0	+150	-150		
250 315	+350	-250	+200	0	+350	-250	+350	-250	+150	-150	+100	0	+150	-150		
315 400	+400	-400	+200	0	+400	-400	+400	-400 ¹⁾	+200	-200	+100	0	+200	-200 ¹⁾		
400 500	+450	-450	+200	0	+400	-400	+450	-450 ¹⁾	+225	-225	+100	0	+225	-225 ¹⁾		
500 630	+500	-500	-	-	+500	-500	+500	-500 ¹⁾	-	-	-	-	-	-		
630 800	+600	-600	-	-	+600	-600	+600	-600 ¹⁾	-	-	-	-	-	-		
800 1 000	+750	-750	-	-	+750	-750	+750	-750 ¹⁾	-	-	-	-	-	-		

Nominal bore diameter d mm	Actual effective outer ring width deviation Δr_{2s}					
	class 0		class 6X		classes 5, 4	
	upper	lower	upper	lower	upper	lower
over 80 up to 120	+100	-100	+ 50	0	+100	-100
120 180	+200	-100	+100	0	+200	-100
180 250	+200	-100	+100	0	+200	-100
250 315	+200	-100	+100	0	+200	-100
315 400	+200	-200	+100	0	+200	-200 ¹⁾
400 500	+225	-225	+100	0	+225	-225 ¹⁾
500 630	-	-	-	-	-	-
630 800	-	-	-	-	-	-
800 1 000	-	-	-	-	-	-

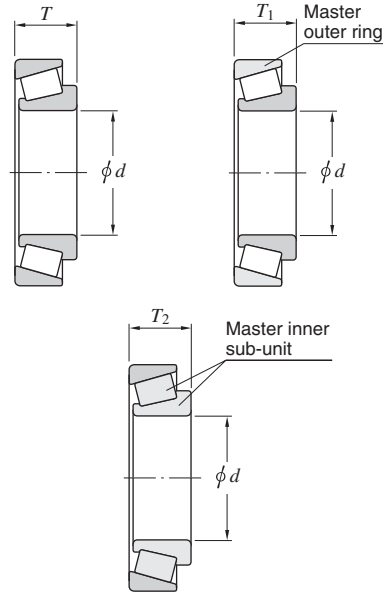

d : nominal bore diameter
 T : nominal assembled bearing width
 T_1 : nominal effective width of inner sub-unit
 T_2 : nominal effective width of outer ring

[Note] 1) These shall be applied to bearings of tolerance class 5.
 [Remark] Values in Italics are prescribed in JTEKT standards.

Table 2-4 Tolerances for metric series double-row and four-row tapered roller bearings (class 0)

= BAS 1002 =

(1) Inner ring, outer ring width and overall width

Unit : μm

Nominal bore diameter d mm	Single plane mean bore diameter deviation Δd_{mp}	V_{dsp}	V_{dmp}	K_{ia}	Single outer ring or inner ring width deviation $\Delta B_s, \Delta C_s$	Actual overall inner rings / outer rings width deviation			
						Double-row ΔT_s		Four-row $\Delta T_s, \Delta W_s$	
						upper	lower	upper	lower
over 50 up to 80	0 - 15	15	11	25	0 - 150	+ 300 - 300	-	-	
80 120	0 - 20	20	15	30	0 - 200	+ 400 - 400	+ 500 - 500	-	
120 180	0 - 25	25	19	35	0 - 250	+ 500 - 500	+ 600 - 600	-	
180 250	0 - 30	30	23	50	0 - 300	+ 600 - 600	+ 750 - 750	-	
250 315	0 - 35	35	26	60	0 - 350	+ 700 - 700	+ 900 - 900	-	
315 400	0 - 40	40	30	70	0 - 400	+ 800 - 800	+1 000 - 1 000	-	
400 500	0 - 45	45	34	80	0 - 450	+ 900 - 900	+1 200 - 1 200	-	
500 630	0 - 60	60	40	90	0 - 500	+1 000 - 1 000	+1 200 - 1 200	-	
630 800	0 - 75	75	45	100	0 - 750	+1 500 - 1 500	-	-	
800 1 000	0 - 100	100	55	115	0 - 1 000	+1 500 - 1 500	-	-	

V_{dsp} : Single plane bore diameter variation, V_{dmp} : Mean bore diameter variation
 K_{ia} : Radial runout of assembled bearing inner ring

(2) Outer ring Unit : μm

Nominal outside diameter D mm	Single plane mean outside diameter deviation ΔD_{mp}	V_{Dsp}	V_{Dmp}	K_{ea}					
					upper	lower	max.	max.	max.
					over	up to	max.	max.	max.
over 80 up to 120	0 - 18	18	14	35					
120 150	0 - 20	20	15	40					
150 180	0 - 25	25	19	45					
180 250	0 - 30	30	23	50					
250 315	0 - 35	35	26	60					
315 400	0 - 40	40	30	70					
400 500	0 - 45	45	34	80					
500 630	0 - 50	60	38	100					
630 800	0 - 75	80	55	120					
800 1 000	0 - 100	100	75	140					
1 000 1 250	0 - 125	130	90	160					
1 250 1 600	0 - 160	170	100	180					

V_{Dsp} : Single plane outside diameter variation
 V_{Dmp} : Mean outside diameter variation
 K_{ea} : Radial runout of assembled bearing outer ring

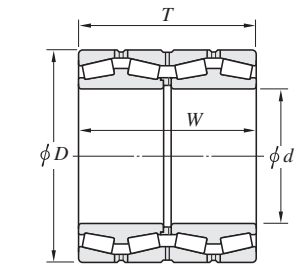
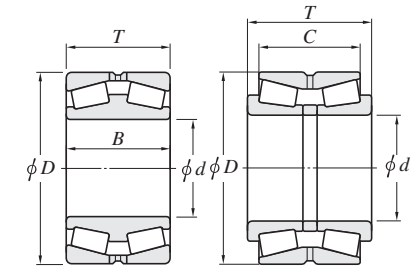

d : nominal bore diameter
 D : nominal outside diameter
 B : nominal double inner ring width
 C : nominal double outer ring width
 T, W : nominal overall width of outer rings (inner rings)

2. Bearing tolerances

Table 2-5 Tolerances for inch series tapered roller bearings = ABMA 19 =

(1) Inner ring

Unit : μm

Applied bearing type	Nominal bore diameter d , mm (1/25.4)		Deviation of a single bore diameter Δ_{ds}							
			Class 4		Class 2		Class 3		Class 0	
	over	up to	upper	lower	upper	lower	upper	lower	upper	lower
All types	-	76.2 (3.0)	+ 13	0	+13	0	+13	0	+13	0
	76.2 (3.0)	266.7 (10.5)	+ 25	0	+25	0	+13	0	+13	0
	266.7 (10.5)	304.8 (12.0)	+ 25	0	+25	0	+13	0	+13	0
	304.8 (12.0)	609.6 (24.0)	+ 51	0	+51	0	+25	0	-	-
	609.6 (24.0)	914.4 (36.0)	+ 76	0	-	-	+38	0	-	-
	914.4 (36.0)	1 219.2 (48.0)	+102	0	-	-	+51	0	-	-
	1 219.2 (48.0)	-	+127	0	-	-	+76	0	-	-

(2) Outer ring

Unit : μm

Applied bearing type	Nominal outside diameter D , mm (1/25.4)		Deviation of a single outside diameter Δ_{Ds}							
			Class 4		Class 2		Class 3		Class 0	
	over	up to	upper	lower	upper	lower	upper	lower	upper	lower
All types	-	266.7 (10.5)	+ 25	0	+25	0	+13	0	+13	0
	266.7 (10.5)	304.8 (12.0)	+ 25	0	+25	0	+13	0	+13	0
	304.8 (12.0)	609.6 (24.0)	+ 51	0	+51	0	+25	0	-	-
	609.6 (24.0)	914.4 (36.0)	+ 76	0	+76	0	+38	0	-	-
	914.4 (36.0)	1 219.2 (48.0)	+102	0	-	-	+51	0	-	-
	1 219.2 (48.0)	-	+127	0	-	-	+76	0	-	-

(3) Radial runout of assembled bearing inner ring / outer ring

Unit : μm

Applied bearing type	Nominal outside diameter D , mm (1/25.4)		Radial runout of inner ring / outer ring K_{ia} , K_{ea}			
			Class 4	Class 2	Class 3	Class 0
	over	up to	max.	max.	max.	max.
All types	-	266.7 (10.5)	51	38	8	4
	266.7 (10.5)	304.8 (12.0)	51	38	8	4
	304.8 (12.0)	609.6 (24.0)	51	38	18	-
	609.6 (24.0)	914.4 (36.0)	76	51	51	-
	914.4 (36.0)	1 219.2 (48.0)	76	-	76	-
	1 219.2 (48.0)	-	76	-	76	-

(4) Assembled bearing width and overall width

Unit : μm

Applied bearing type	Nominal bore diameter d , mm (1/25.4)		Nominal outside diameter D , mm (1/25.4)		Deviation of the actual bearing width and overall width of inner rings / outer rings Δ_{Ts} , Δ_{Ws}							
					Class 4		Class 2		Class 3		Class 0	
	over	up to	over	up to	upper	lower	upper	lower	upper	lower	upper	lower
Single-row	-	101.6 (4.0)	-	-	+ 203	0	+ 203	0	+ 203	- 203	+ 203	- 203
	101.6 (4.0)	266.7 (10.5)	-	-	+ 356	- 254	+ 203	0	+ 203	- 203	+ 203	- 203
	266.7 (10.5)	304.8 (12.0)	-	-	+ 356	- 254	+ 203	0	+ 203	- 203	+ 203	- 203
	304.8 (12.0)	609.6 (24.0)	-	508.0 (20.0)	-	-	+ 381	- 381	+ 203	- 203	-	-
	304.8 (12.0)	609.6 (24.0)	508.0 (20.0)	-	-	-	+ 381	- 381	+ 381	- 381	-	-
	609.6 (24.0)	-	-	-	+ 381	- 381	-	-	+ 381	- 381	-	-
Double-row	-	101.6 (4.0)	-	-	+ 406	0	+ 406	0	+ 406	- 406	+ 406	- 406
	101.6 (4.0)	266.7 (10.5)	-	-	+ 711	- 508	+ 406	- 203	+ 406	- 406	+ 406	- 406
	266.7 (10.5)	304.8 (12.0)	-	-	+ 711	- 508	+ 406	- 203	+ 406	- 406	+ 406	- 406
	304.8 (12.0)	609.6 (24.0)	-	508.0 (20.0)	-	-	+ 762	- 762	+ 406	- 406	-	-
	304.8 (12.0)	609.6 (24.0)	508.0 (20.0)	-	-	-	+ 762	- 762	+ 762	- 762	-	-
	609.6 (24.0)	-	-	-	+ 762	- 762	-	-	+ 762	- 762	-	-
Double-row (TNA type)	-	127.0 (5.0)	-	-	-	-	+ 254	0	+ 254	0	-	-
	127.0 (5.0)	-	-	-	-	-	+ 762	0	+ 762	0	-	-
Four-row	Total dimensional range		-	-	+1 524	-1 524	+1 524	-1 524	+1 524	-1 524	+1 524	-1 524

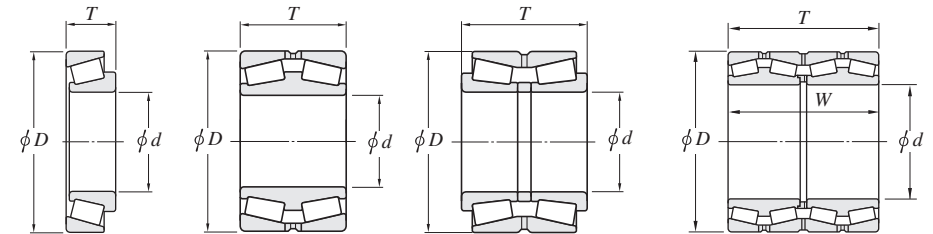

d : nominal bore diameter
 D : nominal outside diameter
 T, W : nominal assembled bearing width and nominal overall width of outer rings (inner rings)

2. Bearing tolerances

Table 2-6 Tolerances for metric J series tapered roller bearings¹⁾

(1) Bore diameter and width of inner ring and assembled bearing width

Unit : μm

Nominal bore diameter d mm		Deviation of a single bore diameter Δ_{ds}								Deviation of a single inner ring width Δ_{Bs}								Deviation of the actual bearing width Δ_{Ts}								Nominal bore diameter d mm	
		Class PK		Class PN		Class PC		Class PB		Class PK		Class PN		Class PC		Class PB		Class PK		Class PN		Class PC		Class PB			
over	up to	upper	lower	upper	lower	upper	lower	upper	lower	upper	lower	upper	lower	upper	lower	upper	lower	upper	lower	upper	lower	upper	lower	upper	lower	over	up to
80	120	0	-20	0	-20	0	-15	0	-10	0	-150	0	-50	0	-300	0	-300	+200	-200	+100	0	+200	-200	+200	-200	80	120
120	180	0	-25	0	-25	0	-18	0	-13	0	-200	0	-50	0	-300	0	-300	+350	-250	+150	0	+350	-250	+200	-250	120	180
180	250	0	-30	0	-30	0	-22	0	-15	0	-200	0	-50	0	-350	0	-350	+350	-250	+150	0	+350	-250	+200	-300	180	250
250	315	0	-35	0	-35	0	-22	0	-15	0	-200	0	-50	0	-350	0	-350	+350	-250	+200	0	+350	-300	+200	-300	250	315

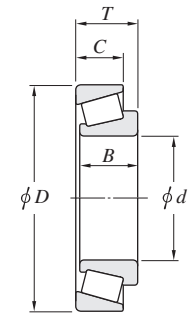

d : nominal bore diameter
 D : nominal outside diameter
 B : nominal inner ring width
 C : nominal outer ring width
 T : nominal assembled bearing width

(2) Outside diameter and width of outer ring and radial runout of assembled bearing inner ring / outer ring

Unit : μm

Nominal outside diameter D mm		Deviation of a single outside diameter Δ_{Ds}								Deviation of a single outer ring width Δ_{Cs}								Radial runout of inner ring / outer ring K_{ia}, K_{ea}				Nominal outside diameter D mm					
		Class PK		Class PN		Class PC		Class PB		Class PK		Class PN		Class PC		Class PB		Class PK	Class PN	Class PC	Class PB						
over	up to	upper	lower	upper	lower	upper	lower	upper	lower	upper	lower	upper	lower	upper	lower	upper	lower	upper	lower	upper	lower	max.	max.	max.	max.	over	up to
120	150	0	-20	0	-20	0	-15	0	-11	0	-200	0	-100	0	-200	0	-200	40	40	7	4	120	150				
150	180	0	-25	0	-25	0	-18	0	-13	0	-200	0	-100	0	-250	0	-250	45	45	8	4	150	180				
180	250	0	-30	0	-30	0	-20	0	-15	0	-250	0	-100	0	-250	0	-250	50	50	10	5	180	250				
250	315	0	-35	0	-35	0	-25	0	-18	0	-250	0	-100	0	-300	0	-300	60	60	11	5	250	315				
315	400	0	-40	0	-40	0	-28	-	-	0	-250	0	-100	0	-300	-	-	70	70	13	-	315	400				

[Note] 1) Bearings with supplementary code "J" attached at the front of bearing number.

Ex. JHM720249/JHM720210, and the like

2. Bearing tolerances

Table 2-7 Tolerances for thrust ball bearings = JIS B 1514 =

(1) Shaft washer

Unit : μm

Nominal bore diameter <i>d</i> mm		Single plane mean bore diameter deviation Δ_{dmp}		Single plane bore diameter variation <i>V_{dsp}</i>	Washer raceway to back face thickness variation <i>S_i¹⁾</i>			Deviation of the actual bearing height Δ_{Ts}	
		classes 0, 6, 5			class 0	class 6	class 5	classes 0, 6, 5	
		over	up to	upper	lower	max.			upper
80	120	0	-20	15	15	8	4	0	-150
120	180	0	-25	19	15	9	5	0	-175
180	250	0	-30	23	20	10	5	0	-200
250	315	0	-35	26	25	13	7	0	-225
315	400	0	-40	30	30	15	7	0	-300
400	500	0	-45	34	30	18	9	0	-375
500	630	0	-50	38	35	21	11	0	-450
630	800	0	-75	55	40	25	13	0	-525
800	1 000	0	-100	75	45	30	15	0	-600
1 000	1 250	0	-125	95	50	35	18	0	-675

[Note] 1) Applies only to thrust ball bearings with 90° contact angle.

[Remark] Values in Italics are prescribed in JTEKT standards.

(2) Housing washer

Unit : μm

Nominal outside diameter <i>D</i> mm		Single plane mean outside diameter deviation Δ_{Dmp}		Single plane outside diameter variation <i>V_{Dsp}</i>	Washer raceway to back face thickness variation <i>S_c¹⁾²⁾</i>
		classes 0, 6, 5			
		over	up to	upper	lower
80	120	0	-22	17	Shall conform to the tolerance <i>S_i</i> on <i>d</i> of the same bearing
120	180	0	-25	19	
180	250	0	-30	23	
250	315	0	-35	26	
315	400	0	-40	30	
400	500	0	-45	34	
500	630	0	-50	38	
630	800	0	-75	55	
800	1 000	0	-100	75	
1 000	1 250	0	-125	95	
1 250	1 600	0	-160	120	

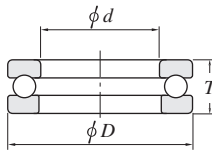

d : shaft washer nominal bore diameter

D : housing washer nominal outside diameter

T : nominal bearing height (single direction)

[Notes] 1) These shall be applied to washer with flat back face only.

2) Applies only to thrust ball bearings with 90° contact angle.

Table 2-8 Accuracies of spherical thrust roller bearings (class 0) = JIS B 1514 =

(1) Shaft washer

Unit : μm

Nominal bore diameter <i>d</i>		Single plane mean bore diameter deviation Δ_{dmp}		Single plane bore diameter variation <i>V_{dsp}</i>	Refer.		
		classes 0, 6, 5			<i>S_d</i>	Deviation of the actual bearing height Δ_{Ts}	
		over	up to	upper		lower	max.
80	120	0	-20	15	25	+200	-200
120	180	0	-25	19	30	+250	-250
180	250	0	-30	23	30	+300	-300
250	315	0	-35	26	35	+350	-350
315	400	0	-40	30	40	+400	-400
400	500	0	-45	34	45	+450	-450
500	630	0	-50	38	60	+500	-500
630	800	0	-75	55	70	+550	-550
800	1 000	0	-100	75	80	+600	-600
1 000	1 250	0	-125	95	100	+650	-650

S_d : Perpendicularity of inner ring face with respect to the bore

[Remark] Values in Italics are prescribed in JTEKT standards.

(2) Housing washer

Unit : μm

Nominal outside diameter <i>D</i> , mm		Single plane mean outside diameter deviation Δ_{Dmp}	
over	up to	upper	lower
120	180	0	-25
180	250	0	-30
250	315	0	-35
315	400	0	-40
400	500	0	-45
500	630	0	-50
630	800	0	-75
800	1 000	0	-100

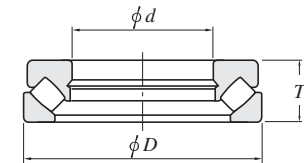

d : shaft washer nominal bore diameter

D : housing washer nominal outside diameter

T : nominal bearing height

2. Bearing tolerances

Table 2-9 Permissible values for chamfer dimensions = JIS B 1514 =

(1) Radial bearing (tapered roller bearings excluded)

Unit : mm

r_{\min} or $r_{1\min}$	Nominal bore diameter d mm		r_{\max} or $r_{1\max}$	
	over	up to	Radial direction	Axial direction
0.6	–	40	1	2
	40	–	1.3	2
1	–	50	1.5	3
	50	–	1.9	3
1.1	–	120	2	3.5
	120	–	2.5	4
1.5	–	120	2.3	4
	120	–	3	5
2	–	80	3	4.5
	80	220	3.5	5
	220	–	3.8	6
2.1	–	280	4	6.5
	280	–	4.5	7
2.5	–	100	3.8	6
	100	280	4.5	6
	280	–	5	7
3	–	280	5	8
	280	–	5.5	8
4	–	–	6.5	9
5	–	–	8	10
6	–	–	10	13
7.5	–	–	12.5	17
9.5	–	–	15	19
12	–	–	18	24
15	–	–	21	30
19	–	–	25	38

[Remarks]

- Value of r_{\max} or $r_{1\max}$ in the axial direction of bearings with nominal width lower than 2 mm shall be the same as the value in radial direction.
- There shall be no specification for the accuracy of the shape of the chamfer surface, but its outline in the axial plane shall not be situated outside of the imaginary circle arc with a radius of r_{\min} or $r_{1\min}$ which contacts the inner ring side face and bore, or the outer ring side face and outside surface.

(2) Radial bearings with locating snap ring (snap ring groove side) and cylindrical roller bearings (separate thrust collar and loose rib side)

Unit : mm

$r_{1\min}$	Nominal bore dia. or nominal outside dia. d or D		$r_{1\max}$	
	over	up to	Radial direction	Axial direction
0.6	–	40	1	1.5
	40	–	1.3	1.5
1	–	50	1.5	2.2
	50	–	1.9	2.2
1.1	–	120	2	2.7
	120	–	2.5	2.7
1.5	–	120	2.3	3.5
	120	–	3	3.5
2	–	80	3	4
	80	220	3.5	4
	220	–	3.8	4
2.1	–	280	4	4.5
	280	–	4.5	4.5
2.5	–	100	3.8	5
	100	280	4.5	5
	280	–	5	5
3	–	280	5	5.5
	280	–	5.5	5.5
4	–	–	6.5	6.5
5	–	–	8	8
6	–	–	10	10

[Remark] There shall be no specification for the accuracy of the shape of the chamfer surface, but its outline in the axial plane shall not be situated outside of the imaginary circle arc with a radius of $r_{1\min}$ which contacts the inner ring side face and bore, or the outer ring side face and outside surface.

(3) Cylindrical roller bearings (non-rib side) and angular contact ball bearings (front face side)

Unit : mm

$r_{1\min}$	Nominal bore dia. or nominal outside dia. d or D		$r_{1\max}$	
	over	up to	Radial direction	Axial direction
0.6	–	40	1	2
	40	–	1.3	2
1	–	50	1.5	3
	50	–	1.9	3
1.1	–	120	2	3.5
	120	–	2.5	4
1.5	–	120	2.3	4
	120	–	3	5
2	–	80	3	4.5
	80	220	3.5	5
	220	–	3.8	6

[Remark] There shall be no specification for the accuracy of the shape of the chamfer surface, but its outline in the axial plane shall not be situated outside of the imaginary circle arc with a radius of $r_{1\min}$ which contacts the inner ring side face and bore, or the outer ring side face and outside surface.

(4) Metric series tapered roller bearing

Unit : mm

r_{\min} or $r_{1\min}$	Nominal bore dia. or nominal outside dia. d or D , mm		r_{\max} or $r_{1\max}$	
	over	up to	Radial direction	Axial direction
0.6	–	40	1.1	1.7
	40	–	1.3	2
1	–	50	1.6	2.5
	50	–	1.9	3
1.5	–	120	2.3	3
	120	250	2.8	3.5
	250	–	3.5	4
2	–	120	2.8	4
	120	250	3.5	4.5
	250	–	4	5
2.5	–	120	3.5	5
	120	250	4	5.5
	250	–	4.5	6
3	–	120	4	5.5
	120	250	4.5	6.5
	250	400	5	7
4	–	120	5.5	7.5
	120	250	6	8
	250	400	6.5	8.5
5	–	180	6.5	8
	180	–	7.5	9
6	–	180	7.5	10
	180	–	9	11
7.5	–	–	12.5	17
9.5	–	–	15	19

[Note] 1) Inner ring shall be included in division d , and outer ring, in division D .

[Remarks]

- There shall be no specification for the accuracy of the shape of the chamfer surface, but its outline in the axial plane shall not be situated outside of the imaginary circle arc with a radius of r_{\min} or $r_{1\min}$ which contacts the inner ring back face and bore, or the outer ring back face and outside surface.
- Values in Italics are provided in JTEKT standards.

(5) Thrust bearing

Unit : mm

r_{\min} OR $r_{1\min}$	r_{\max} OR $r_{1\max}$	
	Radial and axial direction	
0.6	1.5	
1	2.2	
1.1	2.7	
1.5	3.5	
2	4	
2.1	4.5	
3	5.5	
4	6.5	
5	8	
6	10	
7.5	12.5	
9.5	15	
12	18	
15	21	
19	25	

[Remark] There shall be no specification for the accuracy of the shape of the chamfer surface, but its outline in the axial plane shall not be situated outside of the imaginary circle arc with a radius of r_{\min} or $r_{1\min}$ which contacts with the shaft washer back face and bore, or the housing washer back face and outside surface.

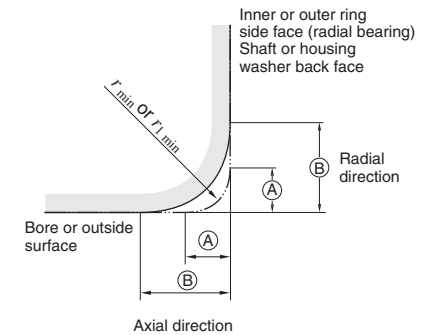

(A) : r_{\min} OR $r_{1\min}$
(B) : r_{\max} OR $r_{1\max}$

2. Bearing tolerances

Table 2-10 Tolerances for tapered bores of radial bearings (class 0 ... JIS B 1514)

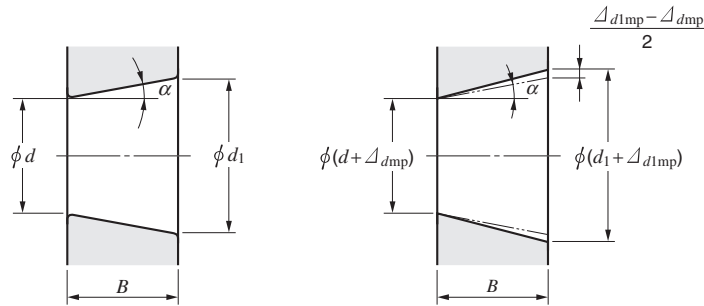

Theoretical tapered bore

Tapered bore with single plane mean bore diameter deviation

(1) Basically tapered bore (taper 1:12) Unit : μm

Nominal bore diameter <i>d</i> , mm	Δ _{dmp}	Δ _{d1mp} - Δ _{dmp}		V _{dsp} ¹⁾
		upper	lower	
over 30 up to 50	+39 0	+25 0	0	16
50 80	+46 0	+30 0	0	19
80 120	+54 0	+35 0	0	22
120 180	+63 0	+40 0	0	40
180 250	+72 0	+46 0	0	46
250 315	+81 0	+52 0	0	52
315 400	+89 0	+57 0	0	57
400 500	+97 0	+63 0	0	63
500 630	+110 0	+70 0	0	70
630 800	+125 0	+80 0	0	-
800 1 000	+140 0	+90 0	0	-
1 000 1 250	+165 0	+105 0	0	-
1 250 1 600	+195 0	+125 0	0	-

(2) Basically tapered bore (taper 1:30) Unit : μm

Nominal bore diameter <i>d</i> , mm	Δ _{dmp}	Δ _{d1mp} - Δ _{dmp}		V _{dsp} ¹⁾
		upper	lower	
over 50 up to 80	+15 0	+30 0	0	19
80 120	+20 0	+35 0	0	22
120 180	+25 0	+40 0	0	40
180 250	+30 0	+46 0	0	46
250 315	+35 0	+52 0	0	52
315 400	+40 0	+57 0	0	57
400 500	+45 0	+63 0	0	63
500 630	+50 0	+70 0	0	70

[Note] 1) These shall be applied to all radial planes with tapered bore, not be applied to bearings of diameter series 7, 8.

[Remark] 1) Symbols of quantity *d*₁: reference diameter at theoretical large end of tapered bore

$$d_1 = d + \frac{1}{12}B \text{ or } d_1 = d + \frac{1}{30}B$$

Δ_{dmp}: single plane mean bore diameter deviation at theoretical small end of tapered bore

Δ_{d1mp}: single plane mean bore diameter deviation at theoretical large end of tapered bore

V_{dsp}: single plane bore diameter variation (a tolerance for the diameter variation given by a maximum value applying in any radial plane of the bore)

B: nominal inner ring width

α: $\frac{1}{2}$ of nominal tapered angle of tapered bore

(tapered ratio 1/12) (tapered ratio 1/30)

α = 2°23'9.4" α = 0°57'17.4"
 = 2.385 94° = 0.954 84°
 = 0.041 643 rad = 0.016 665 rad

3. Bearing fits

3-1 Purpose of fit

The purpose of fit is to securely fix the inner or outer ring to the shaft or housing, to preclude detrimental circumferential sliding on the fitting surface.

Such detrimental sliding (referred to as "creep") will cause abnormal heat generation, wear of the fitting surface, infiltration of abrasion metal particles into the bearing, vibration, and many other harmful effects, which cause a deterioration of bearing functions.

Therefore, it is necessary to fix the bearing ring which is rotating under load to the shaft or housing with interference.

3-2 Tolerance and fit for shaft & housing

For metric series bearings, tolerances for the shaft diameter and housing bore diameter are standardized in JIS B 0401 "limits and fits for engineering" (based on ISO 286 ; shown in Appendixes at the back of this catalog).

Bearing fits on the shaft and housing are determined based on the tolerances specified in the above standard.

Fig. 3-1 shows the relationship between tolerances for shaft and housing bore diameters and fits for bearings of class 0 tolerance.

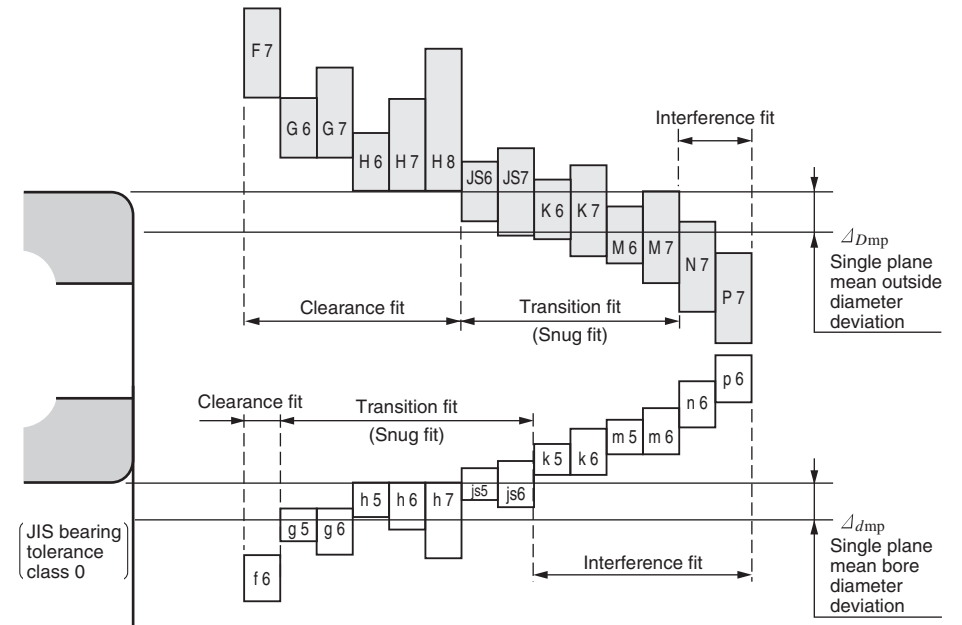

Fig. 3-1 Relationship between tolerances for shaft/housing bore diameters and fits (bearings of class 0 tolerance)

3. Bearing fits

3-3 Fit selection

In selecting the proper fit, careful consideration should be given to bearing operating conditions.

Major specific considerations are :

- Load characteristics and magnitude
- Temperature distribution in operating
- Bearing internal clearance
- Surface finish, material and thickness of shaft and housing
- Mounting and dismounting methods
- Necessity to compensate for shaft thermal expansion at the fitting surface
- Bearing type and size





In view of these considerations, the following paragraphs explain the details of the important factors in fit selection.

1) Load characteristics

Load characteristics are classified into three types : rotating inner ring load; rotating outer ring load and indeterminate direction load.

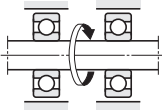
Table 3-1 tabulates the relationship between these characteristics and fit.

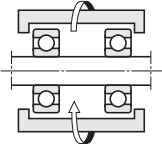
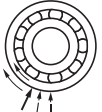
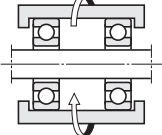
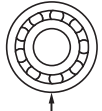
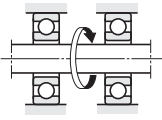
Table 3-1 Load characteristics and fits

Rotation pattern	Direction of load	Loading conditions	Fit		Typical application
			Inner ring & shaft	Outer ring & housing	
 <p>Inner ring : rotating Outer ring : stationary</p>	 <p>Stationary</p>	Rotating inner ring load	Interference fit necessary	Clearance fit acceptable	Spur gear boxes, motors
 <p>Inner ring : stationary Outer ring : rotating</p>	 <p>Rotating with outer ring</p>	Stationary outer ring load	(k, m, n, p, r)	(F, G, H, JS)	Greatly unbalanced wheels
 <p>Inner ring : stationary Outer ring : rotating</p>	 <p>Stationary</p>	Stationary inner ring load	Clearance fit acceptable	Interference fit necessary	Running wheels & pulleys with stationary shaft
 <p>Inner ring : rotating Outer ring : stationary</p>	 <p>Rotating with inner ring</p>	Rotating outer ring load	(f, g, h, js)	(K, M, N, P)	Shaker screens (unbalanced vibration)
Indeterminate	Rotating or stationary	Indeterminate direction load	Interference fit	Interference fit	Cranks

2) Effect of load magnitude

When a radial load is applied, the inner ring will expand slightly. Since this expansion enlarges the circumference of the bore minutely, the initial interference is reduced.

The reduction can be calculated by the following equations :

[In the case of $F_r \leq 0.25 C_0$]

$$\Delta_{dF} = 0.08 \sqrt{\frac{d}{B}} \cdot F_r \times 10^{-3} \dots\dots\dots (3-1)$$

[In the case of $F_r > 0.25 C_0$]

$$\Delta_{dF} = 0.02 \frac{F_r}{B} \times 10^{-3} \dots\dots\dots (3-2)$$

where :

- Δ_{dF} : reduction of inner ring interference mm
- d : nominal bore diameter of bearing mm
- B : nominal inner ring width mm
- F_r : radial load N
- C_0 : basic static load rating N

Consequently, when the radial load, exceeds the C_0 value by more than 25 %, greater interference is needed.

Much greater interference is needed, when impact loads are expected.

3) Effect of fitting surface roughness

The effective interference obtained after fitting differs from calculated interference due to plastic deformation of the ring fitting surface. When the inner ring is fitted, the effective interference, subject to the effect of the fitting surface finish, can be approximated by the following equations :

[In the case of a ground shaft]

$$\Delta_{deff} \doteq \frac{d}{d+2} \Delta_d \dots\dots\dots (3-3)$$

[In the case of a turned shaft]

$$\Delta_{deff} \doteq \frac{d}{d+3} \Delta_d \dots\dots\dots (3-4)$$

where :

- Δ_{deff} : effective interference mm
- Δ_d : calculated interference mm
- d : nominal bore diameter of bearing mm

4) Effect of temperature

A bearing generally has an operating temperature, higher than the ambient temperature. When the inner ring operates under load, its temperature generally becomes higher than that of the shaft and the effective interference decreases due to the greater thermal expansion of the inner ring.

If the assumed temperature difference between the bearing inside and surrounding housing is Δ_t , the temperature difference at the fitting surfaces of the inner ring and shaft will be approximately $(0.10 \text{ to } 0.15) \times \Delta_t$.

The reduction of interference (Δ_{dt}) due to temperature difference is then expressed as follows :

$$\Delta_{dt} = (0.10 \text{ to } 0.15) \Delta_t \cdot \alpha \cdot d \doteq 0.0015 \Delta_t \cdot d \times 10^{-3} \dots\dots\dots (3-5)$$

where :

- Δ_{dt} : reduction of interference due to temperature difference mm
- Δ_t : temperature difference between the inside of the bearing and the surrounding housing °C
- α : linear expansion coefficient of bearing steel ($\doteq 12.5 \times 10^{-6}$) 1/°C
- d : nominal bore diameter of bearing mm

Consequently, when a bearing is higher in temperature than the shaft, greater interference is required.

However, a difference in temperature or in the coefficient of expansion may sometimes increase the interference between outer ring and housing. Therefore, when clearance is provided to accommodate shaft thermal expansion, care should be taken.

3. Bearing fits

5) Maximum stress due to fit

When a bearing is fitted with interference, the bearing ring will expand or contract, generating internal stress.

Should this stress be excessive, the bearing ring may fracture.

The maximum bearing fitting-generated stress is determined by the equation in Table 3-2.

In general, to avoid fracture, it is best to adjust the maximum interference to less than 1/1 000 of the shaft diameter, or the maximum stress (σ), determined by the equation in Table 3-2, should be less than 120 MPa.

Table 3-2 Maximum fitting-generated stress in bearings

Shaft & inner ring	Housing bore & outer ring
(In the case of hollow shaft)	(In the case of $D_h \neq \infty$)
$\sigma = \frac{E}{2} \cdot \frac{\Delta_{def}}{d} \cdot \frac{\left(1 - \frac{d_0^2}{d^2}\right) \left(1 + \frac{d^2}{D_i^2}\right)}{\left(1 - \frac{d_0^2}{D_i^2}\right)}$	$\sigma = E \cdot \frac{\Delta_{Def}}{D} \cdot \frac{\left(1 - \frac{D^2}{D_h^2}\right)}{\left(1 - \frac{D_e^2}{D_h^2}\right)}$
(In the case of solid shaft)	(In the case of $D_h = \infty$)
$\sigma = \frac{E}{2} \cdot \frac{\Delta_{def}}{d} \cdot \left(1 + \frac{d^2}{D_i^2}\right)$	$\sigma = E \cdot \frac{\Delta_{Def}}{D}$

where :

- σ : maximum stress MPa
- d : nominal bore diameter (shaft diameter) mm
- D_i : raceway contact diameter of inner ring mm
 - ball bearing $D_i \doteq 0.2 (D + 4 d)$
 - roller bearing ... $D_i \doteq 0.25 (D + 3 d)$
- Δ_{def} : effective interference of inner ring mm
- d_0 : bore diameter of hollow shaft mm
- D_e : raceway contact diameter of outer ring mm
 - ball bearing $D_e \doteq 0.2 (4D + d)$
 - roller bearing ... $D_e \doteq 0.25 (3D + d)$
- D : nominal outside diameter (bore diameter of housing) mm
- Δ_{Def} : effective interference of outer ring mm
- D_h : outside diameter of housing mm
- E : young's modulus 2.08×10^5 MPa

[Remark] The above equations are applicable when the shaft and housing are steel. When other materials are used, JTEKT should be consulted.

6) Other considerations

When a high degree of accuracy is required, the tolerance of the shaft and housing must be improved. Since the housing is generally less easy to machine precisely than the shaft, it is advisable to use a clearance fit on the outer ring.

With hollow shafts or thin section housings, greater than normal interference is needed.

With split housings, on the other hand, smaller interference with outer ring is needed.

When the housing is made of aluminum or other light metal alloy, relatively greater than normal interference is needed.

In such a case, consult with JTEKT.

Fits recommended for radial bearings and thrust bearings are shown in Tables 3-3 through 3-6. Fits for rolling mill roll neck bearings are described in section 3-4.

Table 3-3 (1) Recommended shaft fits for radial bearings (classes 0, 6X, 6)

Conditions ¹⁾	Ball bearing		Cylindrical roller bearing Tapered roller bearing		Spherical roller bearing		Class of shaft tolerance range	Remarks	Applications (for reference)
	Shaft diameter (mm)								
	over	up to	over	up to	over	up to			
Cylindrical bore bearing (classes 0, 6X, 6)									
Rotating inner ring load or indeterminate direction load	Light load or fluctuating load $\left[\frac{P_r}{C_r} \leq 0.06\right]$	18 100	- 40	- -	- -	js 6	For applications requiring high accuracy, js 5, k 5 and m 5 should be used in place of js 6, k 6 and m 6.	Electric appliances, machine tools, pumps, blowers, carriers etc.	
		100 200	40 140	- -	- -	k 6			
	Normal load $\left[0.06 < \frac{P_r}{C_r} \leq 0.12\right]$	- -	140 200	140 200	- -	- -	m 6	For single-row tapered roller bearings and angular contact ball bearings, k 5 and m 5 may be replaced by k 6 and m 6, because internal clearance reduction due to fit need not be considered.	Electric motors, turbines, internal combustion engines, wood-working machines etc.
		18 100	- 40	- 40	- 40	k 5			
100 140		40 100	40 100	40 65	m 5				
140 200		100 140	65 100	100 140	m 6				
Heavy load or impact load $\left[\frac{P_r}{C_r} > 0.12\right]$	- -	200 280	200 400	140 280	280 500	p 6	Bearings with larger internal clearance than standard are required.	Railway rolling stock axle journals, traction motors	
	- -	- -	- -	280 500	r 6				
	- -	- -	- -	500 -	r 7				
	- -	- -	- -	- -	n 6				
Stationary inner ring load	Inner ring needs to move smoothly on shaft.	All shaft diameters				g 6	For applications requiring high accuracy, g 5 should be used. For large size bearing, f 6 may be used for easier movement.	Stationary shaft wheels	
		Inner ring does not need to move smoothly on shaft.	All shaft diameters				h 6	For applications requiring high accuracy, h 5 should be used.	Tension pulleys, rope sheaves etc.
Central axial load only	All shaft diameters				js 6	-	-		
Tapered bore bearing (class 0) (with adapter or withdrawal sleeve)									
All loads	All shaft diameters				h 9 / IT 5 ²⁾	For transmission shafts, h 10 / IT 7 ²⁾ may be applied.	-		

[Notes] 1) Light, normal, and heavy loads refer to those with dynamic equivalent radial loads (P_r) of 6% or lower, over 6% up to 12% inclusive, and over 12% respectively in relation to the basic dynamic radial load rating (C_r) of the bearing concerned.

2) IT 5 and IT 7 mean that shaft roundness tolerance, cylindricity tolerance, and other errors in terms of shape should be within the tolerance range of IT 5 and IT 7, respectively. For numerical values for standard tolerance grades IT 5 and IT 7, refer to supplementary table at end of this catalog.

[Remark] This table is applicable to solid steel shafts.

3. Bearing fits

Table 3-3 (2) Recommended housing fits for radial bearings (classes 0, 6X, 6)

Conditions			Class of housing bore tolerance range	Remarks	Applications (for reference)	
Housing	Load type etc. ¹⁾	Outer ring axial displacement ²⁾				
One-piece or split type	Stationary outer ring load	All load types	H 7	G 7 may be applied when a large size bearing is used, or if the temperature difference is large between the outer ring and housing.	Ordinary bearing devices, railway rolling stock axle boxes, power transmission equipment etc.	
		Light or normal load	Easily displaceable	H 8	–	
		High temperature at shaft and inner ring		G 7	F 7 may be applied when a large size bearing is used, or if the temperature difference is large between the outer ring and housing.	Drying cylinders etc.
One-piece type	Indeterminate direction load	Light or normal load, requiring high running accuracy	Not displaceable in principle	K 6	Mainly applied to roller bearings.	
			Displaceable	JS 6	Mainly applied to ball bearings.	
		Requiring low-noise rotation	Easily displaceable	H 6	–	
	Rotating outer ring load	Light or normal load	Normally displaceable	JS 7	For applications requiring high accuracy, JS 6 and K 6 should be used in place of JS 7 and K 7.	Electric motors, pumps, crankshaft main bearings etc.
		Normal or heavy load	Not displaceable in principle	K 7	–	Traction motors etc.
		High impact load	Not displaceable	M 7	–	
Rotating outer ring load	Light or fluctuating load	Not displaceable	M 7	–	Conveyor rollers, ropeways, tension pulleys etc.	
	Normal or heavy load		N 7	Mainly applied to ball bearings.	Wheel hubs with ball bearings etc.	
	Thin section housing, heavy or high impact load		P 7	Mainly applied to roller bearings.	Wheel hubs with roller bearings, bearings for large end of connecting rods etc.	

[Notes] 1) Loads are classified as stated in Note 1) to Table 3-3 (1).

2) Indicating distinction between applications of non-separable bearings permitting and not permitting axial displacement of the outer rings.

[Remarks] 1. This table is applicable to cast iron or steel housings.

2. If only central axial load is applied to the bearing, select such tolerance range class as to provide clearance in the radial direction for outer ring.

Table 3-4 Recommended shaft and housing fits for inch series tapered roller bearings (classes 4, 2)

(1) Fits for shaft

Load type		Nominal bore diameter d mm (1/25.4)		Deviation of a single bore diameter $\Delta d_s, \mu\text{m}$		Dimensional tolerance of shaft diameter μm		Remarks		
		over	up to	upper	lower	upper	lower			
Rotating inner ring load	Normal load	76.2 (3.0)	304.8 (12.0)	+25	0	+ 64	+ 38	Generally, bearing internal clearance should be larger than standard.		
		304.8 (12.0)	609.6 (24.0)	+51	0	+127	+ 76			
Rotating outer ring load	Normal load without impact	76.2 (3.0)	304.8 (12.0)	+25	0	+ 25	0		Should be such that average interference stands at $0.0005 \times d$ (mm)	
		304.8 (12.0)	609.6 (24.0)	+51	0	+ 51	0			
Rotating inner ring load	Heavy load Impact load High speed rotation	76.2 (3.0)	304.8 (12.0)	+25	0	0	- 25			Inner ring is displaceable in axial direction.
		304.8 (12.0)	609.6 (24.0)	+51	0	0	- 51			
Rotating outer ring load	Normal load without impact	76.2 (3.0)	304.8 (12.0)	+25	0	0	- 76	Generally, bearing internal clearance should be larger than standard.		
		304.8 (12.0)	609.6 (24.0)	+51	0	0	- 76			
Rotating inner ring load	Heavy load Impact load High speed rotation	76.2 (3.0)	304.8 (12.0)	+25	0	Should be such that average interference stands at $0.0005 \times d$ (mm)				
		304.8 (12.0)	609.6 (24.0)	+51	0					
Rotating outer ring load	Heavy load Impact load High speed rotation	76.2 (3.0)	304.8 (12.0)	+25	0					
		304.8 (12.0)	609.6 (24.0)	+51	0					

(2) Fits for housing

Load type		Nominal outside diameter D mm (1/25.4)		Deviation of a single outside diameter $\Delta D_s, \mu\text{m}$		Dimensional tolerance of housing bore diameter μm		Remarks
		over	up to	upper	lower	upper	lower	
Rotating inner ring load	Used for free or fixed side.	76.2 (3.0)	127.0 (5.0)	+ 25	0	+ 76	+ 51	Outer ring is easily displaceable in axial direction.
		127.0 (5.0)	304.8 (12.0)	+ 25	0	+ 76	+ 51	
		304.8 (12.0)	609.6 (24.0)	+ 51	0	+152	+105	
Rotating inner ring load	Position of outer ring is adjustable (in axial direction).	76.2 (3.0)	127.0 (5.0)	+ 25	0	+ 25	0	Outer ring is displaceable in axial direction.
		127.0 (5.0)	304.8 (12.0)	+ 25	0	+ 51	0	
		304.8 (12.0)	609.6 (24.0)	+ 51	0	+ 76	+ 25	
Rotating outer ring load	Position of outer ring is not adjustable (in axial direction).	76.2 (3.0)	127.0 (5.0)	+ 25	0	- 25	- 51	Outer ring is fixed in axial direction.
		127.0 (5.0)	304.8 (12.0)	+ 25	0	- 25	- 51	
		304.8 (12.0)	609.6 (24.0)	+ 51	0	- 25	- 76	
Rotating outer ring load	Position of outer ring is not adjustable (in axial direction).	76.2 (3.0)	127.0 (5.0)	+ 25	0	- 25	- 102	Outer ring is fixed in axial direction.
		127.0 (5.0)	304.8 (12.0)	+ 25	0	- 25	- 51	
		304.8 (12.0)	609.6 (24.0)	+ 51	0	- 25	- 76	

3. Bearing fits

Table 3-5 Recommended shaft and housing fits for metric J series tapered roller bearings (classes PK, PN)

(1) Fits for shaft

Load type		Nominal bore diameter d mm		Class of shaft tolerance range	Remarks
		over	up to		
Rotating inner ring load	Normal load	10	120	m 6	Generally, bearing internal clearance should be larger than standard.
		120	500	n 6	
	Heavy load Impact load High speed rotation	10	120	n 6	
		120	180	p 6	
		180	250	r 6	
		250	500	r 7	
Rotating outer ring load	Normal load without impact	80	315	h 6 or g 6	Generally, bearing internal clearance should be larger than standard.
	Heavy load Impact load High speed rotation	10	120	n 6	
		120	180	p 6	
		180	250	r 6	
		250	500	r 7	

(2) Fits for housing

Load type		Nominal outside diameter D mm		Class of housing bore diameter tolerance range	Remarks
		over	up to		
Rotating inner ring load	Used for free or fixed side	18	315	G 7	Outer ring is easily displaceable in axial direction.
		315	400	F 6	
	Position of outer ring is adjustable (in axial direction)	18	400	J 7	
	Position of outer ring is not adjustable (in axial direction)	18	400	P 7	Outer ring is fixed in axial direction.
Rotating outer ring load	Position of outer ring is not adjustable (in axial direction)	18	120	R 7	Outer ring is fixed in axial direction.
		120	180		
		180	400		

Table 3-6 Recommended shaft and housing fits for thrust bearings (classes 0, 6)

(1) Fits for shaft

Load type	Shaft diameter, mm		Class of shaft tolerance range	Remarks
	over	up to		
Central axial load (generally for thrust bearings)	All shaft diameters		js 6	h 6 may also be used.
Combined load (spherical thrust roller bearing)	Stationary shaft washer load	All shaft diameters	js 6	–
	Rotating shaft washer load or indeterminate direction load	– 200 400	200 400 –	k 6 m 6 n 6

(2) Fits for housing

Load type	Class of housing bore diameter tolerance range	Remarks
Central axial load (generally for thrust bearings)	–	Select such tolerance range class as provides clearance in the radial direction for housing washer.
	H 8	In case of thrust ball bearings requiring high accuracy.
Combined load (spherical thrust roller bearing)	Stationary housing washer load	H 7
	Indeterminate direction load or rotating housing washer load	K 7 M 7

[Remark] This table is applicable to cast iron or steel housings.

3. Bearing fits

3-4 Recommended fits for rolling mill roll neck bearing

A rolling mill roll neck bearing is subject to inner ring rotating load. Its inner ring always receives a load on its entire circumference, and a load is applied to the outer ring at only one location.

Thus, interference fit is required for the inner ring to prevent any creep, and clearance fit should be used for the outer ring, in principle. For easy attachment, clearance fit has been used for roll neck bearings (because recombination and replacement must be frequently done for roll grinding).

However, with more increase in rolling speed and rolling load, interference fit has been more

commonly used to prevent danger of creep to be generated when clearance fit is used and improve in accuracy of products.

Clearance fit is used for the inner rings of deep groove ball bearings and angular ball bearings used as bearings receiving axial load. Between the outer ring and the chock, adequate clearance should be provided in order to prevent any radial load applied to the outer ring.

Tables 3-7 through 3-10 show the recommended fits for roll neck bearings.

When machining a roll neck or chock, its roundness must not exceed 50 % of the allowable tolerances shown in Tables 3-7 through 3-10. If its roundness is poor, fretting corrosion may frequently occur.

Table 3-8 Recommended fits for roll neck inch series four-row tapered roller bearing

Double cone and roll neck (shaft)						Cup and chock (housing)					
Nominal bore diameter <i>d</i> mm (1/25.4)		Single bore diameter deviation Δd_s μm		Roll neck diameter deviation μm		Nominal outside diameter <i>D</i> mm (1/25.4)		Single outside diameter deviation ΔD_s μm		Chock bore diameter deviation μm	
over	up to	upper	lower	upper	lower	over	up to	upper	lower	upper	lower
76.2 (3.0)	101.6 (4.0)	+ 25	0	- 75	-100	-	304.8 (12.0)	+ 25	0	+ 75	+ 50
101.6 (4.0)	127.0 (5.0)	+ 25	0	-100	-125	304.8 (12.0)	609.6 (24.0)	+ 51	0	+150	+100
127.0 (5.0)	152.4 (6.0)	+ 25	0	-125	-150	609.6 (24.0)	914.4 (36.0)	+ 76	0	+225	+150
152.4 (6.0)	203.2 (8.0)	+ 25	0	-150	-175	914.4 (36.0)	1 219.2 (48.0)	+102	0	+300	+200
203.2 (8.0)	304.8 (12.0)	+ 25	0	-175	-200	1 219.2 (48.0)	1 524.0 (60.0)	+127	0	+375	+250
304.8 (12.0)	609.6 (24.0)	+ 51	0	-200	-250	1 524.0 (60.0)		+127	0	+450	+300
609.6 (24.0)	914.4 (36.0)	+ 76	0	-250	-325						
914.4 (36.0)	1 219.2 (48.0)	+102	0	-300	-400						
1 219.2 (48.0)		+127	0	-375	-475						

Table 3-7 Recommended fits for roll neck metric series four-row tapered roller bearing

Double cone and roll neck (shaft)				Cup and chock (housing)							
Nominal bore diameter <i>d</i> , mm		Single plane mean bore diameter deviation Δd_{mp} μm		Roll neck diameter deviation μm		Nominal outside diameter <i>D</i> , mm		Single plane mean outside diameter deviation ΔD_{mp} μm		Chock bore diameter deviation μm	
over	up to	upper	lower	upper	lower	over	up to	upper	lower	upper	lower
80	120	0	- 20	-120	-150	120	150	0	- 20	+ 57	+ 25
120	180	0	- 25	-150	-175	150	180	0	- 25	+100	+ 50
180	250	0	- 30	-175	-200	180	250	0	- 30	+120	+ 50
250	315	0	- 35	-210	-250	250	315	0	- 35	+115	+ 50
315	400	0	- 40	-240	-300	315	400	0	- 40	+110	+ 50
400	500	0	- 45	-245	-300	400	500	0	- 45	+105	+ 50
500	630	0	- 50	-250	-300	500	630	0	- 50	+100	+ 50
630	800	0	- 75	-325	-400	630	800	0	- 75	+150	+ 75
800	1 000	0	-100	-350	-425	800	1 000	0	-100	+150	+ 75
1 000	1 250	0	-125	-425	-500	1 000	1 250	0	-125	+175	+100
1 250	1 600	0	-160	-510	-600	1 250	1 600	0	-160	+215	+125
						1 600	2 000	0	-200	+250	+150

3. Bearing fits

Table 3-9 Recommended fits for roll neck four-row cylindrical roller bearing (inner ring interference fit)

Inner ring and roll neck (shaft)						Outer ring and chock (housing)					
Nominal bore diameter <i>d</i> , mm		Single plane mean bore diameter deviation Δ_{dmp} μm		Roll neck diameter deviation μm		Nominal outside diameter <i>D</i> , mm		Single plane mean outside diameter deviation Δ_{Dmp} μm		Chock bore diameter deviation μm	
over	up to	upper	lower	upper	lower	over	up to	upper	lower	upper	lower
80	120	0	-20	+59	+37 (p6)	120	150	0	-18	+40	0 (H7)
120	180	0	-25	+68	+43 (p6)	150	180	0	-25	+40	0 (H7)
180	250	0	-30	+79	+50 (p6)	180	250	0	-30	+46	0 (H7)
250	280	0	-35	+126	+94 (r6)	250	315	0	-35	+52	0 (H7)
280	315	0	-35	+130	+98 (r6)						
315	355	0	-40	+144	+108 (r6)						
355	400	0	-40	+150	+114 (r6)	315	400	0	-40	+75	+18 (G7)
400	450	0	-45	+166	+126 (r6)	400	500	0	-45	+83	+20 (G7)
450	500	0	-45	+172	+132 (r6)						
500	560	0	-50	+194	+150 (r6)	500	630	0	-50	+92	+22 (G7)
560	630	0	-50	+354	+310 (s6)						
630	710	0	-75	+390	+340 (s6)	630	800	0	-75	+160	+80 (F7)
710	800	0	-75	+430	+380 (s6)						
800	900	0	-100	+486	+430 (s6)	800	1 000	0	-100	+176	+86 (F7)
900	1 000	0	-100	+526	+470 (s6)						
1 000	1 120	0	-125	+588	+520 (s6)	1 000	1 250	0	-125	+203	+98 (F7)
1 120	1 250	0	-125	+646	+580 (s6)						
						1 250	1 400	0	-160	+235	+110 (F7)
						1 400	1 600	0	-160	+345	+220 (E7)

[Note] The table above shows general values. JTEKT determines recommended fit on a case by case basis according to bearing materials and operating conditions to prevent the inner ring from creeping. Consult with JTEKT when referring to this table.

Table 3-10 Recommended fits of bearing types for support of axial loading

Bearing type	Inner ring and roll neck (shaft)	Outer ring and chock (housing)	
	Shaft tolerance range class	Mounted to chock	Mounted to sleeve
		Chock bore tolerance range class	Sleeve bore tolerance range class
Deep groove ball bearing	e6 or f6	Nominal chock bore (mm) = Outer ring outer dia. + [0.5 to 1.0] H8	G7
Angular ball bearing			
Double row tapered roller bearing (bearings for support of axial loading) ... TDIS type		G7	
Thrust tapered roller bearing			
Spherical thrust roller bearing			

[Remark] When installing a sleeve, clearance of 0.5 mm or more should be provided between the outer diameter of the sleeve and the bore of the chock.

4. Internal clearance

Bearing internal clearance is defined as the total distance either inner or outer ring can be moved when the other ring is fixed.

If movement is in the radial direction, it is called **radial internal clearance**; if in the axial direction, **axial internal clearance**. (Fig. 4-1)

Bearing performance depends greatly upon internal clearance during operation (also referred to as operating clearance); inappropriate clearance results in short rolling fatigue life and generation of heat, noise or vibration.

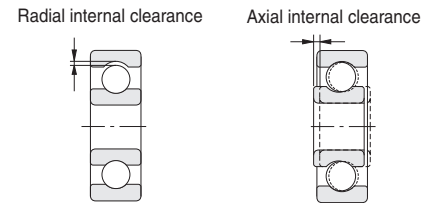

Fig. 4-1 Bearing internal clearance

[Refer.] Relation to radial internal clearance and axial internal clearance

(1) Deep groove ball bearing

$$\Delta_a = \sqrt{\Delta_r (4m_o - \Delta_r)} \dots\dots\dots (4-1)$$

(2) Double-row angular contact ball bearing

$$\Delta_a = 2\sqrt{m_o^2 - (m_o \cos \alpha - \frac{\Delta_r}{2})^2} - 2m_o \sin \alpha \dots\dots\dots (4-2)$$

(3) Matched pair angular contact ball bearing

$$\Delta_a = 2m_o \sin \alpha - 2\sqrt{m_o^2 - (m_o \cos \alpha + \frac{\Delta_r}{2})^2} \dots\dots\dots (4-3)$$

(4) Double/four-row and matched pair tapered roller bearing

$$\Delta_a = \Delta_r \cot \alpha \approx \frac{1.5}{e} \Delta_r \dots\dots\dots (4-4)$$

where :

- Δ_a : Axial internal clearance mm
- Δ_r : Radial internal clearance mm
- α : Nominal contact angle deg.
- e : Limited value of F_a/F_r (shown in the bearing specification table)
- $m_o : r_e + r_i - D_w$ mm
- r_e : Outer ring raceway groove radius mm
- r_i : Inner ring raceway groove radius mm
- D_w : Ball diameter mm

The term **residual clearance** is defined as the original clearance decreased owing to expansion or contraction of a raceway due to fitting, when the bearing is mounted in the shaft and housing.

The term **effective clearance** is defined as the residual clearance decreased owing to dimensional change arising from temperature differentials within the bearing.

The term **operating clearance** is defined as the internal clearance present while a bearing mounted in a machine is rotating under a certain load, or, the effective clearance increased due to elastic deformation arising from bearing loads.

Operating clearance gives great influences on the performance and service life of bearings. Thus, it is recommended to select the operating clearance of a ball bearing so that the operating clearance is slightly positive, while the lower limited value of the operating clearance range of a roller bearing is slightly positive.

It is important to take specific operating conditions into consideration and select a clearance suitable for the conditions.

For example, when high rigidity is required, or when the noise must be minimized, the operating clearance must be reduced. On the other hand, when high operating temperature is expected, the operating clearance must be increased.

Table 4-1 shows how to determine the operating clearance in the case of shaft and housing made of steel. The standard values of bearing internal clearance before mounting are shown in Tables 4-2 through 4-6.

4. Internal clearance

Table 4-1 How to determine operating clearance

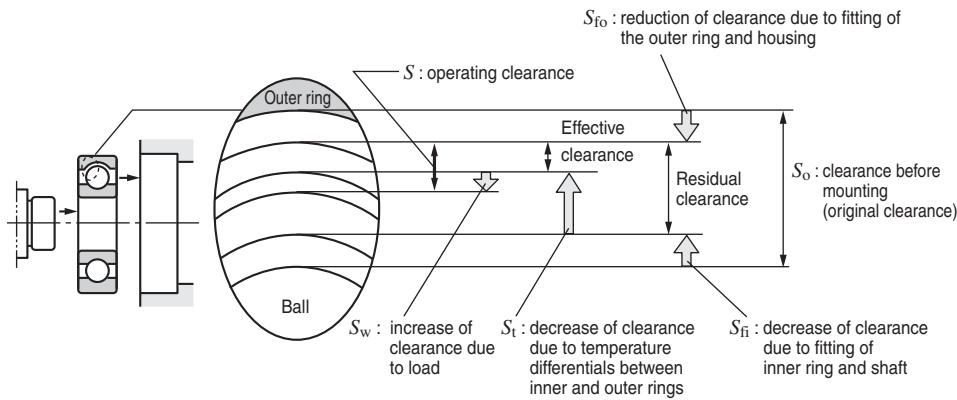

Operating clearance (S)	$S = S_0 - (S_f + S_{t1} + S_{t2}) + S_w^*$ <p>* S_w (increase of clearance due to load) is generally small, and thus may be ignored, although there is an equation for determining the value.</p>	
Decrease of clearance due to fitting (S _f)	(In the case of hollow shaft) $S_{fi} = \Delta_{deff} \frac{d}{D_i} \cdot \frac{\left(1 - \frac{d_0^2}{d^2}\right)}{\left(1 - \frac{d_0^2}{D_i^2}\right)}$ (In the case of solid shaft) $S_{fi} = \Delta_{deff} \frac{d}{D_i}$	(In the case of $D_h \neq \infty$) $S_{fi0} = \Delta_{Deff} \frac{D_e}{D} \cdot \frac{\left(1 - \frac{D^2}{D_h^2}\right)}{\left(1 - \frac{D_e^2}{D_h^2}\right)}$ (In the case of $D_h = \infty$) $S_{fi0} = \Delta_{Deff} \frac{D_e}{D}$
Decrease of clearance due to temperature differentials between inner and outer rings (S _{t1})	The amount of decrease varies depending on the state of housing; however, generally the amount can be approximated by the following equation on the assumption that the outer ring will not expand: $S_{t1} = \alpha (D_i \cdot t_i - D_e \cdot t_e)$	where : $D_e = D_i + 2D_w$ Consequently, $S_{t1} + S_{t2}$ will be determined by the following equation : $S_{t1} + S_{t2} = \alpha \cdot D_i \cdot t_1 + 2\alpha \cdot D_w \cdot t_2$ <p>Temperature differential between the inner and outer rings, t_1, can be expressed as follows : $t_1 = t_i - t_e$ Temperature differential between the rolling element and outer ring, t_2, can be expressed as follows : $t_2 = t_w - t_e$</p>
Decrease of clearance due to temperature rise of rolling element (S _{t2})	$S_{t2} = 2\alpha \cdot D_w \cdot t_w$	

In Table 4-1,

S : operating clearance	mm	Δ_{Deff} : effective interference of outer ring	mm
S ₀ : clearance before mounting	mm	D _h : outside diameter of housing	mm
S _f : decrease of clearance due to fitting	mm	D _e : outer ring raceway contact diameter	mm
S _{fi} : expansion of inner ring raceway contact diameter	mm	(ball bearing $D_e \cong 0.2 (4D + d)$)	
S _{fi0} : contraction of outer ring raceway contact diameter	mm	(roller bearing ... $D_e \cong 0.25 (3D + d)$)	
S _{t1} : decrease of clearance due to temperature differentials between inner and outer rings	mm	D : nominal outside diameter	mm
S _{t2} : decrease of clearance due to temperature rise of the rolling elements	mm	α : linear expansion coefficient of bearing steel (12.5×10^{-6})	1/°C
S _w : increase of clearance due to load	mm	D _w : average diameter of rolling elements	mm
Δ_{deff} : effective interference of inner ring (shaft diameter)	mm	(ball bearing $D_w \cong 0.3 (D - d)$)	
d ₀ : bore diameter of hollow shaft	mm	(roller bearing ... $D_w \cong 0.25 (D - d)$)	
D _i : inner ring raceway contact diameter	mm	t _i : temperature rise of the inner ring	°C
(ball bearing $D_i \cong 0.2 (D + 4 d)$)		t _e : temperature rise of the outer ring	°C
(roller bearing ... $D_i \cong 0.25 (D + 3 d)$)		t _w : temperature rise of rolling elements	°C

■Bearings are sometimes used with a non-steel shaft or housing. In the automotive industry, a statistical method is often incorporated for selection of clearance. In these cases, or when other special operating conditions are involved, JTEKT should be consulted.

4. Internal clearance

Table 4-2 Radial internal clearance of deep groove ball bearings (cylindrical bore)

Unit : μm

Nominal bore diameter <i>d</i> , mm		Clearance									
		C 2		C N		C 3		C 4		C 5	
over	up to	min.	max.	min.	max.	min.	max.	min.	max.	min.	max.
80	100	1	18	12	36	30	58	53	84	75	120
100	120	2	20	15	41	36	66	61	97	90	140
120	140	2	23	18	48	41	81	71	114	105	160
140	160	2	23	18	53	46	91	81	130	120	180
160	180	2	25	20	61	53	102	91	147	135	200
180	200	2	30	25	71	63	117	107	163	150	230
200	225	2	35	25	85	75	140	125	195	175	265
225	250	2	40	30	95	85	160	145	225	205	300
250	280	2	45	35	105	90	170	155	245	225	340
280	315	2	55	40	115	100	190	175	270	245	370
315	355	3	60	45	125	110	210	195	300	275	410
355	400	3	70	55	145	130	240	225	340	315	460
400	450	3	80	60	170	150	270	250	380	350	510
450	500	3	90	70	190	170	300	280	420	390	570
500	560	10	100	80	210	190	330	310	470	440	630
560	630	10	110	90	230	210	360	340	520	490	690
630	710	20	130	110	260	240	400	380	570	540	760
710	800	20	140	120	290	270	450	430	630	600	840
800	900	20	160	140	320	300	500	480	700	670	940
900	1 000	20	170	150	350	330	550	530	770	740	1 040
1 000	1 120	20	180	160	380	360	600	580	850	820	1 150
1 120	1 250	20	190	170	410	390	650	630	920	890	1 260
1 250	1 400	-	-	<i>180</i>	<i>440</i>	<i>420</i>	<i>700</i>	<i>680</i>	<i>1 000</i>	-	-

[Remark] Values in Italics are prescribed in JTEKT standards.

Table 4-3 (1) Axial internal clearance of matched pair angular contact ball bearings (measurement clearance)¹⁾

Unit : μm

Nominal bore diameter <i>d</i> , mm		Contact angle : 15°				Contact angle : 30°							
		C 2		C N		C 2		C N		C 3		C 4	
over	up to	min.	max.	min.	max.	min.	max.	min.	max.	min.	max.	min.	max.
80	100	35	60	85	110	10	30	50	75	80	105	130	155
100	120	40	65	100	125	12	37	65	90	100	125	150	175
120	140	45	75	110	140	15	40	75	105	120	150	180	210
140	160	45	75	125	155	15	40	80	110	130	160	210	240
160	180	50	80	140	170	15	45	95	125	140	170	235	265
180	200	50	80	160	190	20	50	110	140	170	200	275	305

[Note] 1) Including increase of clearance caused by measurement load.

Table 4-3 (2) Axial internal clearance of matched pair angular contact ball bearings (measurement clearance)¹⁾

Unit : μm

Nominal bore diameter <i>d</i> , mm		Contact angle : 40°							
		C 2		C N		C 3		C 4	
over	up to	min.	max.	min.	max.	min.	max.	min.	max.
80	100	6	20	20	45	55	80	85	110
100	120	6	25	25	50	60	85	100	125
120	140	7	30	30	60	75	105	125	155
140	160	7	30	35	65	85	115	140	170
160	180	7	31	45	75	100	130	155	185
180	200	7	37	60	90	110	140	170	200

[Note] 1) Including increase of clearance caused by measurement load.

Table 4-4 Radial internal clearance of cylindrical roller bearings

(1) Cylindrical bore bearings

Unit : μm

Nominal bore diameter <i>d</i> , mm		Clearance									
		C 2		C N		C 3		C 4		C 5	
over	up to	min.	max.	min.	max.	min.	max.	min.	max.	min.	max.
40	50	5	35	30	60	50	80	70	100	95	125
50	65	10	40	40	70	60	90	80	110	110	140
65	80	10	45	40	75	65	100	90	125	130	165
80	100	15	50	50	85	75	110	105	140	155	190
100	120	15	55	50	90	85	125	125	165	180	220
120	140	15	60	60	105	100	145	145	190	200	245
140	160	20	70	70	120	115	165	165	215	225	275
160	180	25	75	75	125	120	170	170	220	250	300
180	200	35	90	90	145	140	195	195	250	275	330
200	225	45	105	105	165	160	220	220	280	305	365
225	250	45	110	110	175	170	235	235	300	330	395
250	280	55	125	125	195	190	260	260	330	370	440
280	315	55	130	130	205	200	275	275	350	410	485
315	355	65	145	145	225	225	305	305	385	455	535
355	400	100	190	190	280	280	370	370	460	510	600
400	450	110	210	210	310	310	410	410	510	565	665
450	500	110	220	220	330	330	440	440	550	625	735
500	560	110	225	220	330	335	470	440	575	-	-
560	630	110	245	220	360	375	520	490	635	-	-
630	710	115	275	245	405	420	580	550	710	-	-
710	800	130	305	275	450	470	675	615	790	-	-
800	900	140	340	300	500	520	720	680	880	-	-
900	1 000	160	380	340	560	580	800	760	980	-	-

4. Internal clearance

Table 4-4 Radial internal clearance of cylindrical roller bearings

(2) Tapered bore bearings

Unit : μm

Nominal bore diameter <i>d</i> , mm		Non-interchangeable clearance													
		C 9 NA ¹⁾		C 1 NA		C 2 NA		C N NA		C 3 NA		C 4 NA		C 5 NA	
over	up to	min.	max.	min.	max.	min.	max.	min.	max.	min.	max.	min.	max.	min.	max.
80	100	10	25	25	45	45	70	80	105	105	125	125	150	180	205
100	120	10	25	25	50	50	80	95	120	120	145	145	170	205	230
120	140	15	30	30	60	60	90	105	135	135	160	160	190	230	260
140	160	15	35	35	65	65	100	115	150	150	180	180	215	260	295
160	180	15	35	35	75	75	110	125	165	165	200	200	240	285	320
180	200	20	40	40	80	80	120	140	180	180	220	220	260	315	355
200	225	20	45	45	90	90	135	155	200	200	240	240	285	350	395
225	250	25	50	50	100	100	150	170	215	215	265	265	315	380	430
250	280	25	55	55	110	110	165	185	240	240	295	295	350	420	475
280	315	30	60	60	120	120	180	205	265	265	325	325	385	470	530
315	355	30	65	65	135	135	200	225	295	295	360	360	430	520	585
355	400	35	75	75	150	150	225	255	330	330	405	405	480	585	660
400	450	45	85	85	170	170	255	285	370	370	455	455	540	650	735
450	500	50	95	95	190	190	285	315	410	410	505	505	600	720	815
500	560	–	–	105	210	210	315	350	455	455	560	560	665	–	–
560	630	–	–	115	230	230	345	390	505	505	620	620	735	–	–
630	710	–	–	130	260	260	390	435	565	565	695	695	825	–	–
710	800	–	–	145	290	290	435	485	630	630	775	775	920	–	–
800	900	–	–	160	320	320	480	540	700	700	860	860	1 020	–	–
900	1 000	–	–	180	360	360	540	600	780	780	960	960	1 140	–	–

[Note] 1) Clearance C9NA should be applied to tapered cylindrical roller bearings of JIS tolerance classes 5 and 4.

Table 4-5 Radial internal clearance of double / four-row and matched pair tapered roller bearings

(1) Cylindrical bore bearings

Unit : μm

Nominal bore diameter <i>d</i> , mm		Clearance									
		C 1		C 2		C N		C 3		C 4	
over	up to	min.	max.	min.	max.	min.	max.	min.	max.	min.	max.
80	100	0	20	20	45	45	70	70	100	100	130
100	120	0	25	25	50	50	80	80	110	110	150
120	140	0	30	30	60	60	90	90	120	120	170
140	160	0	30	30	65	65	100	100	140	140	190
160	180	0	35	35	70	70	110	110	150	150	210
180	200	0	40	40	80	80	120	120	170	170	230
200	225	0	40	40	90	90	140	140	190	190	260
225	250	0	50	50	100	100	150	150	210	210	290
250	280	0	50	50	110	110	170	170	230	230	320
280	315	0	60	60	120	120	180	180	250	250	350
315	355	0	70	70	140	140	210	210	280	280	390
355	400	0	70	70	150	150	230	230	310	310	440
400	450	0	80	80	170	170	260	260	350	350	490
450	500	0	90	90	190	190	290	290	390	390	540
500	560	0	100	100	210	210	320	320	430	430	590
560	630	0	110	110	230	230	350	350	480	480	660
630	710	0	130	130	260	260	400	400	540	540	740
710	800	0	140	140	290	290	450	450	610	610	830
800	900	0	160	160	330	330	500	500	670	670	920
900	1 000	0	180	180	370	370	550	550	730	730	990
1 000	1 250	0	200	200	420	420	610	610	790	790	1 050
1 250	1 600	0	220	220	460	460	650	650	850	850	1 100
1 600	2 000	0	240	240	480	480	680	680	900	900	1 150

(2) Tapered bore bearings

Unit : μm

Nominal bore diameter <i>d</i> , mm		Clearance									
		C 1		C 2		C N		C 3		C 4	
over	up to	min.	max.	min.	max.	min.	max.	min.	max.	min.	max.
80	100	20	45	45	70	70	100	100	130	130	170
100	120	25	50	50	80	80	110	110	150	150	200
120	140	30	60	60	90	90	120	120	170	170	230
140	160	30	65	65	100	100	140	140	190	190	260
160	180	35	70	70	110	110	150	150	210	210	280
180	200	40	80	80	120	120	170	170	230	230	310
200	225	40	90	90	140	140	190	190	260	260	340
225	250	50	100	100	150	150	210	210	290	290	380
250	280	50	110	110	170	170	230	230	320	320	420
280	315	60	120	120	180	180	250	250	350	350	460
315	355	70	140	140	210	210	280	280	390	390	510
355	400	70	150	150	230	230	310	310	440	440	580
400	450	80	170	170	260	260	350	350	490	490	650
450	500	90	190	190	290	290	390	390	540	540	720
500	560	100	210	210	320	320	430	430	590	590	790
560	630	110	230	230	350	350	480	480	660	660	880
630	710	130	260	260	400	400	540	540	740	740	990
710	800	140	290	290	450	450	610	610	830	830	1 100
800	900	160	330	330	500	500	670	670	920	920	1 240

4. Internal clearance

Table 4-6 Radial internal clearance of spherical roller bearings

(1) Cylindrical bore bearings

Unit : μm

Nominal bore diameter <i>d</i> , mm		Clearance									
		C 2		C N		C 3		C 4		C 5	
over	up to	min.	max.	min.	max.	min.	max.	min.	max.	min.	max.
80	100	35	60	60	100	100	135	135	180	180	225
100	120	40	75	75	120	120	160	160	210	210	260
120	140	50	95	95	145	145	190	190	240	240	300
140	160	60	110	110	170	170	220	220	280	280	350
160	180	65	120	120	180	180	240	240	310	310	390
180	200	70	130	130	200	200	260	260	340	340	430
200	225	80	140	140	220	220	290	290	380	380	470
225	250	90	150	150	240	240	320	320	420	420	520
250	280	100	170	170	260	260	350	350	460	460	570
280	315	110	190	190	280	280	370	370	500	500	630
315	355	120	200	200	310	310	410	410	550	550	690
355	400	130	220	220	340	340	450	450	600	600	750
400	450	140	240	240	370	370	500	500	660	660	820
450	500	140	260	260	410	410	550	550	720	720	900
500	560	150	280	280	440	440	600	600	780	780	1 000
560	630	170	310	310	480	480	650	650	850	850	1 100
630	710	190	350	350	530	530	700	700	920	920	1 190
710	800	210	390	390	580	580	770	770	1 010	1 010	1 300
800	900	230	430	430	650	650	860	860	1 120	1 120	1 440
900	1 000	260	480	480	710	710	930	930	1 220	1 220	1 570
1 000	1 120	290	530	530	780	780	1 020	1 020	1 330	1 330	1 720
1 120	1 250	320	580	580	860	860	1 120	1 120	1 460	1 460	1 870
1 250	1 400	350	640	640	950	950	1 240	1 240	1 620	1 620	2 060
1 400	1 600	400	720	720	1 060	1 060	1 380	1 380	1 800	1 800	2 300
1 600	1 800	450	810	810	1 180	1 180	1 550	1 550	2 000	2 000	2 550

(2) Tapered bore bearings

Unit : μm

Nominal bore diameter <i>d</i> , mm		Clearance									
		C 2		C N		C 3		C 4		C 5	
over	up to	min.	max.	min.	max.	min.	max.	min.	max.	min.	max.
80	100	55	80	80	110	110	140	140	180	180	230
100	120	65	100	100	135	135	170	170	220	220	280
120	140	80	120	120	160	160	200	200	260	260	330
140	160	90	130	130	180	180	230	230	300	300	380
160	180	100	140	140	200	200	260	260	340	340	430
180	200	110	160	160	220	220	290	290	370	370	470
200	225	120	180	180	250	250	320	320	410	410	520
225	250	140	200	200	270	270	350	350	450	450	570
250	280	150	220	220	300	300	390	390	490	490	620
280	315	170	240	240	330	330	430	430	540	540	680
315	355	190	270	270	360	360	470	470	590	590	740
355	400	210	300	300	400	400	520	520	650	650	820
400	450	230	330	330	440	440	570	570	720	720	910
450	500	260	370	370	490	490	630	630	790	790	1 000
500	560	290	410	410	540	540	680	680	870	870	1 100
560	630	320	460	460	600	600	760	760	980	980	1 230
630	710	350	510	510	670	670	850	850	1 090	1 090	1 360
710	800	390	570	570	750	750	960	960	1 220	1 220	1 500
800	900	440	640	640	840	840	1 070	1 070	1 370	1 370	1 690
900	1 000	490	710	710	930	930	1 190	1 190	1 520	1 520	1 860
1 000	1 120	530	770	770	1 030	1 030	1 300	1 300	1 670	1 670	2 050
1 120	1 250	570	830	830	1 120	1 120	1 420	1 420	1 830	1 830	2 250
1 250	1 400	620	910	910	1 230	1 230	1 560	1 560	2 000	2 000	2 450
1 400	1 600	680	1 000	1 000	1 350	1 350	1 720	1 720	2 200	2 200	2 700
1 600	1 800	750	1 110	1 110	1 500	1 500	1 920	1 920	2 400	2 400	2 950

5. Lubrication

Lubrication is one of the most important factors determining bearing performance. The suitability of the lubricant and lubrication method have a dominant influence on bearing life.

Functions of lubrication :

- To lubricate each part of the bearing, and to reduce friction and wear
- To carry away heat generated inside bearing due to friction and other causes
- To cover rolling contact surface with the proper oil film in order to prolong bearing fatigue life
- To prevent corrosion and contamination by dirt

Bearing lubrication is classified broadly into two categories: grease lubrication and oil lubrication. Table 5-1 makes a general comparison between the two.

Table 5-1 Comparison between grease and oil lubrication

Item	Grease	Oil
· Sealing device	Easy	Slightly complicated and special care required for maintenance
· Lubricating ability	Good	Excellent
· Rotation speed	Low/medium speed	Applicable at high speed as well
· Replacement of lubricant	Slightly troublesome	Easy
· Life of lubricant	Relatively short	Long
· Cooling effect	No cooling effect	Good (circulation is necessary)
· Filtration of dirt	Difficult	Easy

5-1 Grease lubrication

Grease lubrication is widely applied since there is no need for replenishment over a long period once grease is filled, and a relatively simple structure can suffice for the lubricant sealing device.

There are two methods of grease lubrication. One is the closed lubrication method, in which grease is filled in advance into shielded/sealed bearing; the other is the feeding method, in which the bearing and housing are filled with grease in proper quantities at first, and refilled at a regular interval via replenishment or replacement.

Devices with numerous grease inlets sometimes employ the centralized lubricating method, in which the inlets are connected via piping and supplied with grease collectively.

1) Amount of grease

In general, grease should fill approximately one-third to one-half the inside space, though this varies according to structure and inside space of housing.

It must be borne in mind that excessive grease will generate heat when churned, and will consequently alter, deteriorate, or soften.

When the bearing is operated at low speed, however, the inside space is sometimes filled with grease to two-thirds to full, in order to preclude infiltration of contaminants.

2) Replenishment/replacement of grease

The method of replenishing/replacing grease depends largely on the lubrication method. Whichever method may be utilized, care should be taken to use clean grease and to keep dirt or other foreign matter out of the housing.

In addition, it is desirable to refill with grease of the same brand as that filled at the start.

When grease is refilled, new grease must be injected inside bearing.

Fig. 5-1 gives one example of a feeding method.

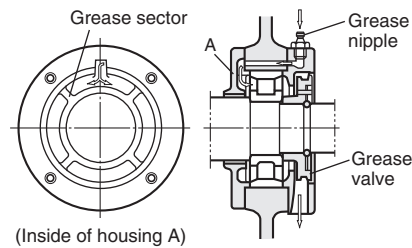

Fig. 5-1 Example of grease feeding method (using grease sector)

In the example, the inside of the housing is divided by grease sectors. Grease fills one sector, then flows into the bearing.

On the other hand, grease flowing back from the inside is forced out of the bearing by the centrifugal force of the grease valve.

When the grease valve is not used, it is necessary to enlarge the housing space on the discharge side to store old grease.

The housing is uncovered and the stored old grease is removed at regular intervals.

3) Grease feeding interval

In normal operation, grease life should be regarded roughly as shown in Fig. 5-2, and replenishment/replacement should be carried out accordingly.

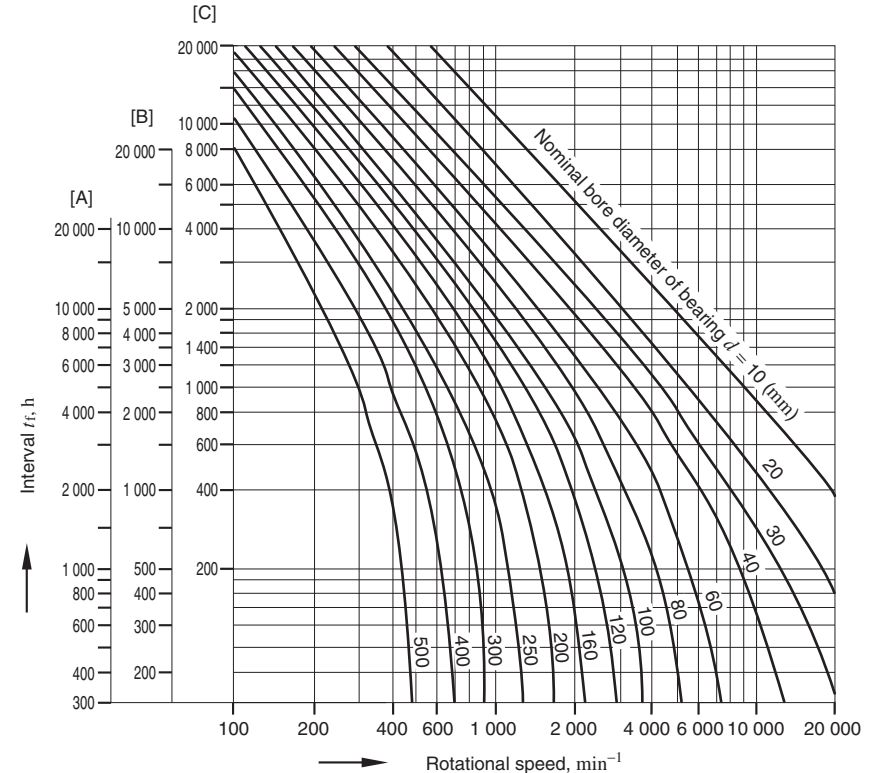

[Notes] 1) [A] : radial ball bearing

2) Temperature correction

[B] : cylindrical roller bearing, needle roller bearing

When the bearing operating temperature exceeds 70 °C, t_f' , obtained by multiplying t_f by correction coefficient a , found on the scale below, should be applied as the feeding interval.

[C] : tapered roller bearing, spherical roller bearing, thrust ball bearing

$$t_f' = t_f \times a$$

Temperature correction coefficient a

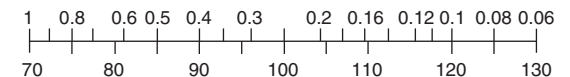

Bearing operating temperature T °C

Fig. 5-2 Grease feeding interval

5-2 Oil lubrication

Oil lubrication is usable even at high speed rotation and somewhat high temperature, and is effective in reducing bearing vibration and noise.

Thus oil lubrication is used in many cases where grease lubrication does not work.

Table 5-2 shows major types and methods of oil lubrication.

Table 5-2 Type and method of oil lubrication

<p>(1) Oil bath</p>	<ul style="list-style-type: none"> Simplest method of bearing immersion in oil for operation. Suitable for low/medium speed. Oil level gauge should be furnished to adjust the amount of oil. (In the case of horizontal shaft) About 50 % of the lowest rolling element should be immersed. (In the case of vertical shaft) About 70 to 80 % of the bearing should be immersed. It is better to use a magnetic plug to prevent wear iron particles from dispersing in oil. 	<p>a magnetic plug</p>
<p>(2) Oil drip</p>	<ul style="list-style-type: none"> Oil is dripped with an oiling device, and the inside of the housing is filled with oil mist by the action of rotating parts. This method has a cooling effect. Applicable at relatively high speed and up to medium load. In general, 5 to 6 drops of oil are utilized per minute. (It is difficult to adjust the dripping in 1 mL/h or smaller amounts.) It is necessary to prevent too much oil from being accumulated at the bottom of housing. 	
<p>(3) Oil splash</p>	<ul style="list-style-type: none"> This type of lubrication method makes use of a gear or simple flinger attached to shaft in order to splash oil. This method can supply oil for bearings located away from the oil tank. Usable up to relatively high speed. It is necessary to keep oil level within a certain range. It is better to use a magnetic plug to prevent wear iron particles from dispersing in oil. It is also advisable to set up a shield or baffle board to prevent contaminants from entering the bearing. 	

<p>(4) Forced oil circulation</p>	<ul style="list-style-type: none"> This method employs a circulation-type oil supply system. Supplied oil lubricates inside of the bearing, is cooled and sent back to the tank through an oil escape pipe. The oil, after filtering and cooling, is pumped back. Widely used at high speeds and high temperature conditions. It is better to use an oil escape pipe approximately twice as thick as the oil supply pipe in order to prevent too much lubricant from gathering in housing. Required amount of oil : see Remark 1 (on page 60). 	
<p>(5) Oil jet lubrication</p>	<ul style="list-style-type: none"> This method uses a nozzle to jet oil at a constant pressure (0.1 to 0.5 MPa), and is highly effective in cooling. Suitable for high speed and heavy load. Generally, the nozzle (diameter 0.5 to 2 mm) is located 5 to 10 mm from the side of a bearing. When a large amount of heat is generated, 2 to 4 nozzles should be used. Since a large amount of oil is supplied in the jet lubrication method, old should be discharged with an oil pump to prevent excessive residual oil. Required amount of oil : see Remark 1 (on page 60). 	
<p>(6) Oil mist lubrication (spray lubrication)</p>	<ul style="list-style-type: none"> This method employs an oil mist generator to produce dry mist (air containing oil in the form of mist). The dry mist is continuously sent to the oil supplier, where the mist is turned into a wet mist (sticky oil drops) by a nozzle set up on the housing or bearing, and is then sprayed onto bearing. Required amount of mist : see Remark 2 (on page 61). 	<ul style="list-style-type: none"> This method provides and sustains the smallest amount of oil film necessary for lubrication, and has the advantages of preventing oil contamination, simplifying bearing maintenance, prolonging bearing fatigue life, reducing oil consumption etc.
<p>(Example of grinding machine)</p>	<p>Supply of oil</p> <p>Discharge of oil</p>	<p>(Example of rolling mill)</p> <p>Supply of oil</p> <p>Discharge of oil</p>

(7)
Oil / air
lubrication

- A proportioning pump sends forth a small quantity of oil, which is mixed with compressed air by a mixing valve. The admixture is supplied continuously and stably to the bearing.
- This method enables quantitative control of oil in extremely small amounts, always supplying new lubricating oil. It is thus suitable for machine tools and other applications requiring high speed.
- Compressed air and lubricating oil are supplied to the spindle, increasing the internal pressure and helping prevent dirt, cutting-liquid, etc. from entering. As well, this method allows the lubricating oil to flow through a feeding pipe, minimizing atmospheric pollution.

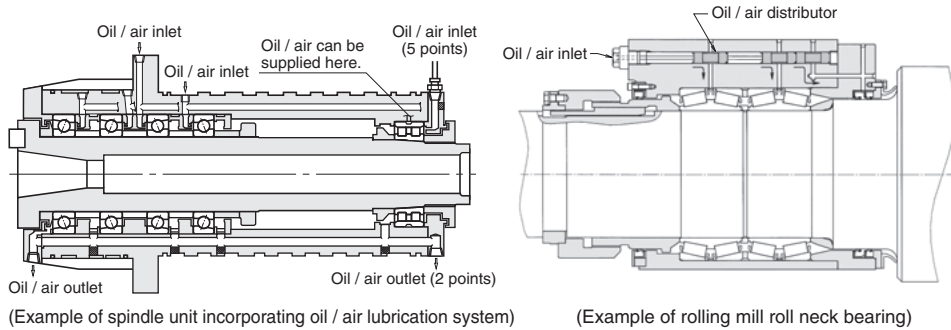

Remark 1 Required oil supply in forced oil circulation ; oil jet lubrication methods

$$G = \frac{1.88 \times 10^{-4} \mu \cdot d \cdot n \cdot P}{60 \cdot c \cdot r \cdot \Delta T}$$

where :

- G : required oil supply L/min
- μ : friction coefficient (see table at right)
- d : nominal bore diameter mm
- n : rotational speed min^{-1}
- P : dynamic equivalent load of bearing N
- c : specific heat of oil 1.88–2.09kJ/kg·K
- r : density of oil g/cm^3
- ΔT : temperature rise of oil K

Values of friction coefficient μ

Bearing type	μ
Deep groove ball bearing	0.001 0 – 0.001 5
Angular contact ball bearing	0.001 2 – 0.002 0
Cylindrical roller bearing	0.000 8 – 0.001 2
Tapered roller bearing	0.001 7 – 0.002 5
Spherical roller bearing	0.002 0 – 0.002 5

The values obtained by the above equation show quantities of oil required to carry away all the generated heat, with heat release not taken into consideration.

In reality, the oil supplied is generally half to two-thirds of the calculated value.

Heat release varies widely according to the application and operating conditions.

To determine the optimum oil supply, it is advised to start operating with two-thirds of the calculated value, and then reduce the oil gradually while measuring the operating temperature of bearing, as well as the supplied and discharged oil.

Remark 2 Notes on oil mist lubrication

- 1) Required amount of mist (mist pressure : 5 kPa)

(In the case of a bearing) $Q = 0.11dR$

(In the case of two oil seals combined) $Q = 0.028d_1$

where :

- Q : required amount of mist L/min
- d : nominal bore diameter mm
- R : number of rolling element rows
- d_1 : inside diameter of oil seal mm

In the case of high speed ($d_m n \geq 400 \times 10^3$), it is necessary to increase the amount of oil and heighten the mist pressure.

- 2) Piping diameter and design of lubrication hole/groove

When the flow rate of mist in piping exceeds 5 m/s, oil mist suddenly condenses into an oil liquid.

Consequently, the piping diameter and dimensions of the lubrication hole/groove in the housing should be designed to keep the flow rate of mist, obtained by the following equation, from exceeding 5 m/s.

$$V = \frac{0.167Q}{A} \leq 5$$

where :

- V : flow rate of mist m/s
- Q : amount of mist L/min
- A : sectional area of piping or lubrication groove cm^2

- 3) Mist oil
Oil used in oil mist lubrication should meet the following requirements.

- ability to turn into mist
- has high extreme pressure resistance
- good heat/oxidation stability
- rust-resistant
- unlikely to generate sludge
- superior demulsifier

Oil mist lubrication has a number of advantages for high speed rotation bearings. Its performance, however, is largely affected by surrounding structures and bearing operating conditions.

If contemplating the use of this method, please contact with JTEKT for advice based on JTEKT long experience with oil mist lubrication.

Remark 3 Required oil supply in oil / air lubrication (Rolling mill roll neck bearing)

Horizontal roll $Q = \frac{0.085dR}{A}$

Vertical roll $Q = \frac{0.170dR}{A}$

where :

- Q : Required oil supply cm^3/h
- d : Nominal bore diameter mm
- R : Number of rolling element rows
- A : Coefficient (low speed : 10, high speed : 5)

5. Lubrication

5-3 Lubricant

5-3-1 Grease

Grease is made by mixing and dispersing a solid of high oil-affinity (called a thickener) with lubricant oil (as a base), and transforming it into a semi-solid state.

As well, a variety of additives can be added to improve specific performance.

(1) Base oil

Mineral oil is usually used as the base oil for grease. When low temperature fluidity, high temperature stability, or other special performance is required, diester oil, silicon oil, polyglycolic oil, fluorinated oil, or other synthetic oil is often used.

Generally, grease with a low viscosity base oil is suitable for applications at low temperature or high rotation speed; grease with high viscosity base oils are suitable for applications at high temperature or under heavy load.

(2) Thickener

Most greases use a metallic soap base such as lithium, sodium, or calcium as thickeners. For some applications, however, non-soap base thickeners (inorganic substances such as bentone, silica gel, and organic substances such as urea compounds, fluorine compounds) are also used.

In general, the mechanical stability, bearing operating temperature range, water resistance, and other characteristics of grease are determined by the thickener.

(Lithium soap base grease)

Superior in heat resistance, water resistance and mechanical stability.

(Calcium soap base grease)

Superior in water resistance; inferior in heat resistance.

(Sodium soap base grease)

Superior in heat resistance; inferior in water resistance.

(Non-soap base grease)

Superior in heat resistance.

(3) Additives

Various additives are selectively used to serve the respective purposes of grease applications.

- Extreme pressure agents
When bearings must tolerate heavy or impact loads.
- Oxidation inhibitors
When grease is not refilled for a long period. Structure stabilizers, rust preventives, and corrosion inhibitors are also used.

(4) Consistency

Consistency, which indicates grease hardness, is expressed as a figure obtained, in accordance with ASTM (JIS), by multiplication by 10 the depth (in mm) to which the cone-shaped metallic plunger penetrates into the grease at 25 °C by deadweight in 5 seconds. The softer the grease, the higher the figure.

Table 5-4 shows the relationships between the NLGI scales and ASTM (JIS) penetration indexes, service conditions of grease.

(NLGI : National Lubricating Grease Institute)

Table 5-4 Grease consistency

NLGI scale	ASTM (JIS) penetration index (25 °C, 60 mixing operations)	Service conditions/ applications
0	355 – 385	For centralized lubricating
1	310 – 340	For centralized lubricating, at low temperature
2	265 – 295	For general use
3	220 – 250	For general use, at high temperature
4	175 – 205	For special applications

(5) Mixing of different greases

Since mixing of different greases changes their properties, greases of different brands should not be mixed.

If mixing cannot be avoided, greases containing the same thickener should be used. Even if the mixed greases contain the same thickener, however, mixing may still produce adverse effects, due to difference in additives or other factors.

Thus it is necessary to check the effects of a mixture in advance, through testing or other methods.

Table 5-3 Characteristics of respective greases

	Lithium grease			Calcium grease (cup grease)	Sodium grease (fiber grease)	Complex base grease			Non-soap base grease			
	Mineral oil	Synthetic oil (diester oil)	Synthetic oil (silicon oil)	Mineral oil	Sodium soap	Lithium complex soap	Calcium complex soap	Bentone	Urea compounds	Fluorine compounds	Thickener	
Thickener	Lithium soap			Calcium soap	Sodium soap							
Base oil	Mineral oil	Synthetic oil (diester oil)	Synthetic oil (silicon oil)	Mineral oil	Mineral oil	Mineral oil	Mineral oil	Mineral oil	Mineral/ synthetic oil	Synthetic oil	Base oil	
Dropping point (°C)	170 to 190	170 to 230	220 to 260	80 to 100	160 to 180	250 or higher	200 to 280	–	240 or higher	250 or higher	Dropping point (°C)	
Operating temperature range (°C)	– 30 to + 120	– 50 to + 130	– 50 to + 180	– 10 to + 70	0 to + 110	– 30 to + 150	– 10 to + 130	– 10 to + 150	– 30 to + 150	– 40 to + 250	Operating temperature range (°C)	
Rotation speed range	Medium to high	High	Low to medium	Low to medium	Low to high	Low to high	Low to medium	Medium to high	Low to high	Low to medium	Rotation speed range	
Mechanical stability	Excellent	Good to excellent	Good	Fair to good	Good to excellent	Good to excellent	Good	Good	Good to excellent	Good	Mechanical stability	
Water resistance	Good	Good	Good	Good	Bad	Good to excellent	Good	Good	Good to excellent	Good	Water resistance	
Pressure resistance	Good	Fair	Bad to fair	Fair	Good to excellent	Good	Good	Good to excellent	Good to excellent	Good	Pressure resistance	
Remarks	Most widely usable for various rolling bearings.	Superior low temperature and friction characteristics. Suitable for bearings for measuring instruments and extra-small ball bearings for small electric motors.	Superior high and low temperature characteristics.	Suitable for applications at low rotation speed and under light load. Not applicable at high temperature.	Liable to emulsify in the presence of water. Used at relatively high temperature.	Superior mechanical stability and heat resistance. Used at relatively high temperature.	Superior pressure resistance when extreme pressure agent is added. Used in bearings for rolling mills.	Suitable for applications at high temperature and under relatively heavy load.	Superior water resistance, oxidation stability, and heat stability. Suitable for applications at high temperature and high speed.	Superior chemical resistance and solvent resistance. Usable at up to 250 °C.		Remarks

5. Lubrication

5-3-2 Lubricating oil

For lubrication, bearings usually employ highly refined mineral oils, which have superior oxidation stability, rust-preventive effect, and high film strength.

With bearing diversification, however, various synthetic oils have been put into use.

These synthetic oils contain various additives (oxidation inhibitors, rust preventives, antifoaming agents, etc.) to improve specific properties. Table 5-5 shows the characteristics of lubricating oils.

Mineral lubricating oils are classified by applications in JIS and MIL.

Table 5-5 Characteristics of lubricating oils

Type of lubricating oil	Highly refined mineral oil	Major synthetic oils				
		Diester oil	Silicon oil	Polyglycolic oil	Polyphenyl ether oil	Fluorinated oil
Operating temperature range (°C)	-40 to +220	-55 to +150	-70 to +350	-30 to +150	0 to +330	-20 to +300
Lubricity	Excellent	Excellent	Fair	Good	Good	Excellent
Oxidation stability	Good	Good	Fair	Fair	Excellent	Excellent
Radioactivity resistance	Bad	Bad	Bad to fair	Bad	Excellent	-

[Selection of lubricating oil]

The most important criterion in selecting a lubricating oil is whether the oil provides proper viscosity at the bearing operating temperature.

Standard values of proper kinematic viscosity can be obtained through selection by bearing type according to Table 5-6 first, then through selection by bearing operating conditions according to Table 5-7.

When lubricating oil viscosity is too low, the oil film will be insufficient. On the other hand, when the viscosity is too high, heat will be generated due to viscous resistance.

In general, the heavier the load and the higher the operating temperature, the higher the lubricating oil viscosity should be; whereas, the higher the rotation speed, the lower the viscosity should be.

Fig. 5-3 illustrates the relationship between lubricating oil viscosity and temperature.

Table 5-6 Proper kinematic viscosity by bearing type

Bearing type	Proper kinematic viscosity at operating temperature
Ball bearing Cylindrical roller bearing	13 mm ² /s or higher
Tapered roller bearing Spherical roller bearing	20 mm ² /s or higher
Spherical thrust roller bearing	32 mm ² /s or higher

Table 5-7 Proper kinematic viscosities by bearing operating conditions

Operating temperature	d _m n value	Proper kinematic viscosity (expressed in the ISO viscosity grade or the SAE No.)	
		Light/normal load	Heavy/impact load
-30 ~ 0 °C	All rotation speeds	ISO VG 15, 22, 46 (Refrigerating machine oil)	-
	300 000 or lower	ISO VG 46 (Bearing oil Turbine oil)	ISO VG 68 (Bearing oil Turbine oil) SAE 30
0 ~ 60 °C	300 000 to 600 000	ISO VG 32 (Bearing oil Turbine oil)	ISO VG 68 (Bearing oil Turbine oil)
	600 000 or higher	ISO VG 7, 10, 22 (Bearing oil)	-
	300 000 or lower	ISO VG 68 (Bearing oil)	ISO VG 68, 100 (Bearing oil) SAE 30
60 ~ 100 °C	300 000 to 600 000	ISO VG 32, 46 (Bearing oil Turbine oil)	ISO VG 68 (Bearing oil Turbine oil)
	600 000 or higher	ISO VG 22, 32, 46 (Bearing oil Turbine oil Machine oil)	-
	300 000 or lower	ISO VG 68, 100 (Bearing oil) SAE 30, 40	ISO VG 100 ~ 460 (Bearing oil Gear oil)
100 ~ 150 °C	300 000 to 600 000	ISO VG 68 (Bearing oil Turbine oil) SAE 30	ISO VG 68, 100 (Bearing oil) SAE 30, 40

- [Remarks] 1. $d_m n = \frac{D+d}{2} \times n$ { D : nominal outside diameter (mm), d : nominal bore diameter (mm), n : rotational speed (min⁻¹) }
2. Refer to refrigerating machine oil (JIS K 2211), turbine oil (JIS K 2213), gear oil (JIS K 2219), machine oil (JIS K 2238) and bearing oil (JIS K 2239).
3. Please contact with JTEKT if the bearing operating temperature is under -30 °C or over 150 °C.

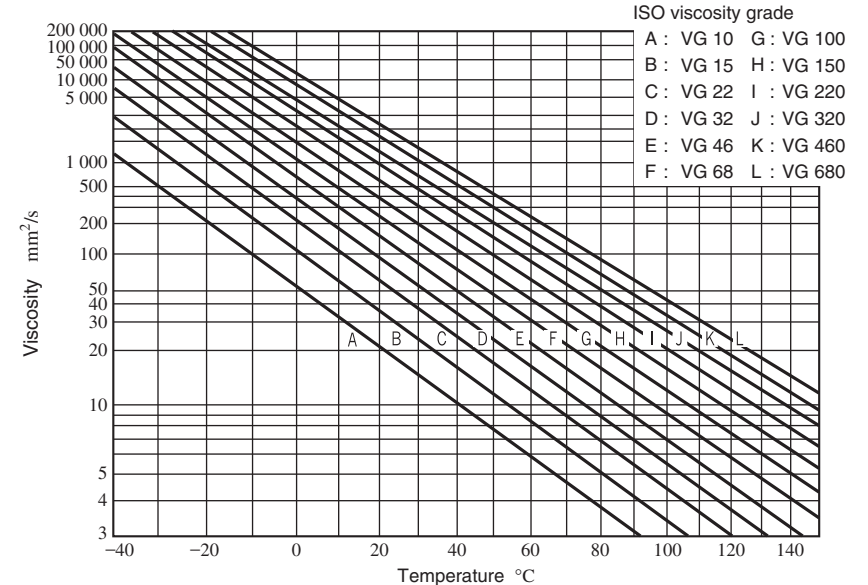

Fig. 5-3 Relationship between lubricating oil viscosity and temperature (viscosity index : 100)

6. Bearing materials

Bearing materials include steel for bearing rings and rolling elements, as well as steel sheet, steel, copper alloy and synthetic resins for cages.

These bearing materials should possess the following characteristics :

- | | |
|--|--------------------|
| 1) High elasticity, durable under high partial contact stress. | } Bearing rings |
| 2) High strength against rolling contact fatigue due to large repetitive contact load. | |
| 3) Strong hardness | } Rolling elements |
| 4) High abrasion resistance | |
| 5) High toughness against impact load | } Bearing rings |
| 6) Excellent dimensional stability | |

6-1 Bearing rings and rolling elements materials

1) High carbon chromium bearing steel

High carbon chromium bearing steel specified in JIS is used as a general material in bearing rings (inner rings, outer rings) and rolling elements (balls, rollers).

Their chemical composition classified by steel type is given in Table 6-1.

Among these steel types, SUJ 2 is generally used. SUJ 3, which contains additional Mn and Si, possesses high hardenability and is commonly used for thick section bearings.

SUJ 5 has increased hardenability, because it was developed by adding Mo to SUJ 3.

For small and medium size bearings, SUJ 2 and SUJ 3 are used, and for large size and extra-large size bearings with thick sections, SUJ 5 is widely used.

Generally, these materials are processed into the specified shape and then undergo hardening and annealing treatment until they attain a hardness of 57 to 64 HRC.

Table 6-1 Chemical composition of high carbon chromium bearing steel

Standard	Code	Chemical composition (%)							
		C	Si	Mn	P	S	Cr	Mo	
JIS G 4805	SUJ 2	0.95 ~ 1.10	0.15 ~ 0.35	Not more than 0.50	Not more than 0.025	Not more than 0.025	1.30 ~ 1.60	Not more than 0.08	
	SUJ 3		0.40 ~ 0.70	0.90 ~ 1.15				0.90 ~ 1.20	Not more than 0.08
	SUJ 5		0.40 ~ 0.70	0.90 ~ 1.15				0.90 ~ 1.20	0.10 ~ 0.25
SAE J 404	52100	0.98 ~ 1.10	0.15 ~ 0.35	0.25 ~ 0.45	Not more than 0.025	Not more than 0.025	1.30 ~ 1.60	Not more than 0.06	

[Remark] As for bearings which are induction hardened, carbon steel with a high carbon content of 0.55 to 0.65 % is used in addition to those listed in this table.

2) Case carburizing bearing steel (case hardened steel)

When a bearing receives heavy impact loads, the surface of the bearing should be hard and the inside soft.

Such materials should possess a proper amount of carbon, dense structure, and carburizing case depth on their surface, while having proper hardness and fine structure internally.

For this purpose, chromium steel and nickel-chromium-molybdenum steel are used as materials.

Typical steel materials are shown in Table 6-2.

These materials also undergo vacuum degassing in order to reduce non-metallic inclusions and oxygen content which leads to higher reliability.

3) Others

For special applications, the following materials are used, according to operational conditions.

(When very high reliability is required)

- high refining steel ... developed by JTEKT
- vacuum arc remelted steel
- electro slag remelted steel

(When heat resistance is required)

- high speed steel for high temperature bearings ... refer to Table 6-3

(When high corrosion resistance is required)

- stainless steel ... refer to Table 6-4

(When high heat, corrosion, and chemical resistance are required)

- ceramics

Table 6-2 Chemical composition of case carburizing bearing steel

Standard	Code	Chemical composition (%)								
		C	Si	Mn	P	S	Ni	Cr	Mo	
JIS G 4053	SCr 415	0.13 ~ 0.18	0.15 ~ 0.35	0.60 ~ 0.85	Not more than 0.030	Not more than 0.030	-	0.90 ~ 1.20	-	
	SCr 420	0.18 ~ 0.23		0.60 ~ 0.85				0.90 ~ 1.20	-	
	SCM 420	0.18 ~ 0.23		0.60 ~ 0.85				0.90 ~ 1.20	0.15 ~ 0.30	
	SNCM 220	0.17 ~ 0.23		0.60 ~ 0.90				0.40 ~ 0.70	0.40 ~ 0.65	0.15 ~ 0.30
	SNCM 420	0.17 ~ 0.23		0.40 ~ 0.70				1.60 ~ 2.00	0.40 ~ 0.65	0.15 ~ 0.30
	SNCM 815	0.12 ~ 0.18		0.30 ~ 0.60				4.00 ~ 4.50	0.70 ~ 1.00	0.15 ~ 0.30
SAE J 404	5120	0.17 ~ 0.22	0.15 ~ 0.35	0.70 ~ 0.90	Not more than 0.035	Not more than 0.040	-	0.70 ~ 0.90	-	
	8620	0.18 ~ 0.23		0.70 ~ 0.90				0.40 ~ 0.70	0.40 ~ 0.60	0.15 ~ 0.25
	4320	0.17 ~ 0.22	0.15 ~ 0.30	0.45 ~ 0.65	Not more than 0.025	Not more than 0.025	1.65 ~ 2.00	0.40 ~ 0.60	0.20 ~ 0.30	

Table 6-3 Chemical composition of high speed steel for high temperature bearings

Standard	Code	Chemical composition (%)											
		C	Si	Mn	P	S	Cr	Mo	V	Ni	Cu	Co	W
AISI	M 50	0.77 ~ 0.85	Not more than 0.25	Not more than 0.35	Not more than 0.015	Not more than 0.015	3.75 ~ 4.25	4.00 ~ 4.50	0.90 ~ 1.10	Not more than 0.10	Not more than 0.10	Not more than 0.25	Not more than 0.25

Table 6-4 Chemical composition of stainless steel

Standard	Code	Chemical composition (%)						
		C	Si	Mn	P	S	Cr	Mo
JIS G 4303	SUS 440 C	0.95 ~ 1.20	Not more than 1.00	Not more than 1.00	Not more than 0.040	Not more than 0.030	16.00 ~ 18.00	Not more than 0.75

6. Bearing materials

6-2 Materials used for cages

Since the characteristics of materials used for cages greatly influence the performance and reliability of rolling bearings, the choice of materials is of great importance.

It is necessary to select cage materials in accordance with required shape, ease of lubrication, strength, and abrasion resistance.

Typical materials used for metallic cages are shown in Tables 6-5 and 6-6.

In addition, phenolic resin machined cages and other synthetic resin molded cages are often used.

Materials typically used for molded cages are polyacetal, polyamide (Nylon 6.6, Nylon 4.6), and polymer containing fluorine, which are strengthened with glass and carbon fibers.

Table 6-5 Chemical compositions of pressed cage steel sheet (A) and machined cage carbon steel (B)

	Standard	Code	Chemical composition (%)						
			C	Si	Mn	P	S	Ni	Cr
(A)	JIS G 3141	SPCC	Not more than 0.12	–	Not more than 0.50	Not more than 0.040	Not more than 0.045	–	–
	JIS G 3131	SPHC	Not more than 0.15	–	Not more than 0.60	Not more than 0.050	Not more than 0.050	–	–
	BAS 361	SPB 2	0.13 ~ 0.20	Not more than 0.04	0.25 ~ 0.60	Not more than 0.030	Not more than 0.030	–	–
	JIS G 4305	SUS 304	Not more than 0.08	Not more than 1.00	Not more than 2.00	Not more than 0.045	Not more than 0.030	8.00 ~ 10.50	18.00 ~ 20.00
(B)	JIS G 4051	S 25 C	0.22 ~ 0.28	0.15 ~ 0.35	0.30 ~ 0.60	Not more than 0.030	Not more than 0.035	–	–

Table 6-6 Chemical composition of high-tensile brass casting of machined cages (%)

Standard	Code	Cu	Zn	Mn	Fe	Al	Sn	Ni	Impurity	
									Pb	Si
JIS H 5120	CAC 301 (HBsC*)	55 ~ 60	33 ~ 42	0.1 ~ 1.5	0.5 ~ 1.5	0.5 ~ 1.5	Not more than 1.0	Not more than 1.0	Not more than 0.4	Not more than 1.0

* : Material with HBsC is used.

7. Examples of failures

Table 7-1 (1) Bearing failures, causes and countermeasures





Failures	Characteristics	Damages		Causes	Countermeasures
(1) Flaking	 <p>Flaking caused by excessive axial load</p> <p>Inner ring of four-row tapered roller bearing</p>	<p>Flaking on bearing raceway surface generated on only rows receiving axial load</p>		<p>1) Crossed work rolls causing excessive axial load</p> <ul style="list-style-type: none"> · Roll neck diameter is smaller than the standard one. · Chock side liner is worn. · Inaccuracy of mill stand. · Rigidity of the chock is poor. · Corrosion on liner or clearance generated between the liner and the chock. · Failure of the keeper plate. 	<p>1) Keep the correct locations of the chock and work roll.</p>
	 <p>Outer ring raceway of four-row tapered roller bearing</p>	<p>Flaking generated and developed from raceway end face</p>		<p>1) Looseness of chock cover/excessive axial clearance</p> <p style="margin-left: 20px;">(As the axial clearance is increased, the loading range becomes narrower, partial load acts, and edge load is generated on the outer ring raceway.)</p> <p>2) Excessive axial clearance is generated because of the mixed use of other bearing spacer or outer ring.</p>	<p>1) Adjust shims, select thickness of shims, measure a gap, and tighten bolts correctly.</p> <p>2) Use parts of the same number.</p>
	<p>Flaking caused by improper mounting</p> <p>Loading position (1) Loading position (2)</p>  <p>1st row 2nd row 3rd row 4th row</p> <p>(1) (2)</p> <p>(2) (3) (4)</p> <p>(3) (4)</p> <p>Loading position (3) Loading position (4)</p>  <p>Outer ring raceway of four-row tapered roller bearing</p>	<p>Flaking on raceway surface with slanted contact</p>		<p>1) It occurs when the chock is fixed inappropriately and slantingly.</p> <ul style="list-style-type: none"> · Failure of keeper plate Removal, looseness, damage, deformation, bend, unequal tightening, unequal wear, improper parallelism · Damaged, deformed, or bent chock flange 	<p>1) Find the cause of damage by periodic inspection of the chock and stand.</p>
	 <p>Flaking at corroded start point</p> <p>Outer ring raceway of four-row tapered roller bearing</p>	<p>Flaking on raceway surface started from corroded (rusted) portion</p>		<p>1) After the bearing was used, it has been left for a long period with moisture mixed in grease.</p> <p>2) Improper rust preventive treatment after the bearing was washed.</p> <p>3) Worn or damaged seal lips</p> <p>4) Corrosion on the raceway is generated due to the clearance between the roll neck and the sleeve, and flaking occurs with rust.</p>	<p>1) Improve seal maintenance and sealing method. Periodically check for wear or damage on the seal lips.</p> <p>2) Fit the "O" ring between the roll neck and the sleeve.</p> <p>3) Immediately after the bearing is removed from the chock, change grease.</p> <p>4) After washing the bearing, remove kerosene and water completely.</p>

Table 7-1 (2) Bearing failures, causes and countermeasures





Failures	Characteristics	Damages		Causes	Countermeasures
(1) Flaking	 <p>Flaking on nicks (scratch) start point</p> <p>Rolling contact surface of four-row cylindrical roller bearing</p>	Flaking on rolling contact surface with nicks start point		1) Inappropriate handling · Mounting / dismounting bearing to / from chock · Replacing roll	1) Proper handling jig (use of a copper hammer) 2) Prevention of impact load when replacing roll (use of soft material) 3) Improvement in mounting method 4) Change in raceway chamfering
	 <p>Outer ring raceway of double-row cylindrical roller bearing</p>	Flaking on raceway surface		1) Low viscosity lubrication (improper lubrication) 2) Ingress of dusts and foreign matters	1) Improvement in viscosity of oil and oil type 2) Improvement in seal maintenance and sealing method Periodic check of wear or damage of seal lip 3) Check of oil filter
	 <p>Inner ring raceway of double-row cylindrical roller bearing</p>  <p>Inner ring raceway of double-row cylindrical roller bearing</p>				
(2) Cracking Chipping	 <p>Inner ring side face of four-row tapered roller bearing</p>	Minute crack on inner ring side face		1) Fix the inner ring and the roll with a fillet ring (thrust collar). 2) Clearance between the fillet ring (thrust collar) and the inner ring is excessively small. 3) Area of the side face of nut/slinger contacting the inner ring side face is too small, the side face is worn due to inner ring creep, causing heat.	1) Keep the clearance between the inner ring and the fillet ring (thrust collar) (from 0.5 mm to 1.5 mm). 2) Keep the area of the side of fillet ring (thrust collar) (to reduce pressure on the side face). 3) Apply and supply grease of adequate amount.
	 <p>Rolling contact surface of four-row cylindrical roller bearing</p>	Cracking on rolling elements		1) Application of load greater than bearing load rating (Load resistance of roller by use of pin type cage) 2) Secondary factor in case of damaged pin of cage (For a reversible mill, pins are broken due to fatigue caused by rapid acceleration and deceleration) 3) Other factors · Ingress of water due to faulty sealing · Increase of axial clearance of bearing, causing application of partial and excessive load	1) Optimal design of bearing considering load and operating conditions (Examination of optimal cage type) 2) Reviewing sealing method and design of strength of cover

Table 7-1 (3) Bearing failures, causes and countermeasures



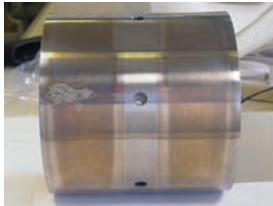
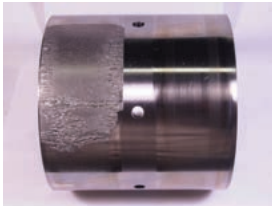

Failures	Characteristics	Damages		Causes	Countermeasures
<p>(2) Cracking Chipping</p>	<div style="display: flex; justify-content: space-around;"> <div style="text-align: center;">  <p>Outer ring outside surface of double-row cylindrical roller bearing</p> </div> <div style="text-align: center;">  <p>Outer ring side face of double-row cylindrical roller bearing</p> </div> </div> <div style="text-align: center; margin-top: 10px;">  <p>Outer ring outside of double-row cylindrical roller bearing</p> </div>	<p>Crack on outer ring</p>		<ol style="list-style-type: none"> 1) Impact load acting due to accidents of rolling mill (for example, plate being caught in, ingress of dusts) 2) Rolling load acting unevenly due to uneven overall thickness of bearing in the shaft, causing excessive load to a thick section bearing (for multi-roll mill, BUR bearing) 	<ol style="list-style-type: none"> 1) Change to outer ring material or heat treated material hard to be cracked. 2) Appropriate overall thickness control of bearings in a shaft
	<div style="display: flex; justify-content: space-around;"> <div style="text-align: center;">  <p>Inner ring raceway of four-row cylindrical roller bearing</p> </div> <div style="text-align: center;">  <p>Inner ring raceway of four-row cylindrical roller bearing</p> </div> </div>	<p>Grinding burn or crack on inner ring raceway surface</p>		<ol style="list-style-type: none"> 1) After fitting an inner ring into the roll neck, grinding burn occurs during grinding with the inner ring and the roll. 2) Crack occurs because rollers rolling on the raceway surface of which strength (hardness) is decreased due to grinding burn. 	<ol style="list-style-type: none"> 1) Reviewing grinding conditions Grain size of grinding stone, grinding stone cutting amount, cutting pressure, grinding fluid amount, etc.
	<div style="text-align: center;">  <p>Outer ring outside surface of double-row cylindrical roller bearing</p> </div>	<p>Grinding burn or crack on outer ring outside surface</p>		<ol style="list-style-type: none"> 1) Grinding burn occurs when re-grinding the outer ring of a multi-roll mill bearing. 2) Crack occurs because the outer ring of which strength (hardness) is decreased by grinding burn contacts with the intermediate roll. 	

Table 7-1 (4) Bearing failures, causes and countermeasures



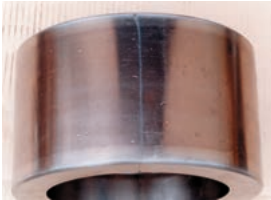

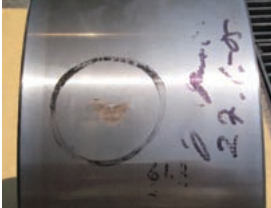

Failures	Characteristics	Damages		Causes	Countermeasures
(2) Cracking Chipping	 Inner ring of spherical roller bearing	 Fractured section of inner ring	Axial crack occurs on bore surface of inner ring and raceway surface.	1) Excessive interference between inner ring and shaft 2) Great fit stress due to excessive difference in temperature of inner ring and that of shaft	1) Appropriate fit conditions of inner ring and shaft 2) Appropriate difference in temperature by checking load, rotation, and temperature conditions. (appropriate fit)
	 Inner ring bore surface of four-row tapered roller bearing		Circumferential crack occurs on bore surface and raceway surface of inner ring.	1) Step wear occurs on the shaft (roll neck), and the inner ring overrides the shaft, causing great bore surface stress	1) Provide circumferential groove for the roll neck. 2) When using a bearing with different chamfers for a roll, make the chamfers identical.
	 Outer ring raceway of double-row tapered roller bearing	 Fractured section of outer ring	Axial crack occurs on outside surface and raceway surface of outer ring.	1) Excessive axial load 2) Axial clearance between the bearing and roll is great, and excessive axial load is applied.	1) Check for axial load. 2) Check the wear condition of counterpart components. 3) Reviewing thickness of the outer ring
	 Inner ring raceway of spherical thrust roller bearing	 Assembly of tapered roller bearing	Crack occurs on inner ring back face rib.	1) Excessive axial load 2) Low holding shoulder diameter on the inner ring back face rib	1) Reviewing operating conditions 2) Reviewing dimensions of counterpart collar (Dimensions allowing backup of inner ring back face rib)

Table 7-1 (5) Bearing failures, causes and countermeasures

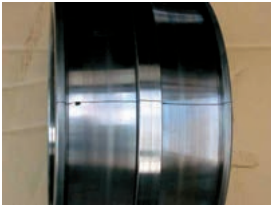

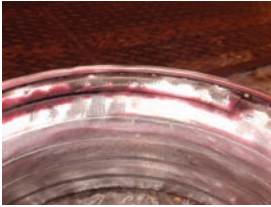

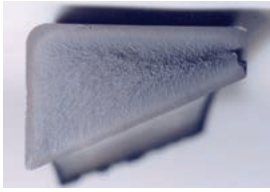
Failures	Characteristics	Damages		Causes	Countermeasures
(3) Brinelling Nicks	 <p>Outer ring raceway surface of four-row tapered roller bearing</p>  <p>Rolling contact surface of four-row cylindrical roller bearing</p>	<p>1) Brinelling (Nicks) on raceway and rolling contact surfaces (scratch)</p> <p>2) Brinelling on raceway surface at the same interval as rolling element spacing</p>		<p>1) Nicks occur on the raceway and rollers because of improper handling.</p> <ul style="list-style-type: none"> · Mounting / dismounting bearing to / from chock · Replacing roll <p>2) Great bending load is applied to the roll neck. (Especially, when faulty rolling occurs)</p>	<p>1) Proper handling jig (use of a copper hammer)</p> <p>2) Application of grease to raceway surface of inner and outer rings (Apply oil if the bearing is the oil lubricated type)</p> <p>3) Prevention of impact load when replacing roll (Use of soft material)</p> <p>4) Roll bending compared to bearing static load rating</p> <p>5) Improvement in mounting method</p> <p>6) Change in raceway chamfering</p> <p>7) Check for excessive load on the slant chamfer of the raceway surface</p>
(4) Scratch Scuffing	 <p>Roller end face of double-row cylindrical roller bearing</p>  <p>Outer ring rib of double-row cylindrical roller bearing</p>  <p>Roller large end face of double-row tapered roller bearing</p>	<p>Scuffing on roller end face and rib of the raceway</p>		<p>1) Improper lubrication, ingress of foreign matters</p> <p>2) Abnormal axial load caused by improper mounting or control of bearing overall thickness</p> <p>3) Excessive axial load</p> <p>4) Excessive preload</p>	<p>1) Selection of appropriate oil type and supply of adequate lubricant</p> <p>2) Reviewing bearing mounting location</p> <p>3) Reviewing bearing overall thickness control</p> <p>4) Reviewing operating conditions</p> <p>5) Checking preload</p>

Table 7-1 (6) Bearing failures, causes and countermeasures



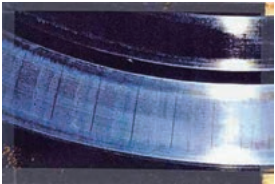

Failures	Characteristics	Damages		Causes	Countermeasures
(5) Smearing	<div style="display: flex; flex-wrap: wrap;"> <div style="width: 50%;">  <p>Outer ring raceway surface of four-row tapered roller bearing</p> </div> <div style="width: 50%;">  <p>Outer ring raceway surface of spherical roller bearing</p> </div> <div style="width: 50%;">  <p>Outer ring raceway surface of spherical roller bearing</p> </div> <div style="width: 50%;">  <p>Rolling element surface of spherical roller bearing</p> </div> </div>	Smearing on raceway or rolling contact surface		<ol style="list-style-type: none"> 1) Improper lubrication 2) Slip of rolling elements (high speed, light load) 3) Ingress of foreign matters during maintenance 	<ol style="list-style-type: none"> 1) Selection of appropriate oil type and supply of adequate lubricant 2) Setup of appropriate preload 3) Prevention of ingress of foreign matters
(6) Corrosion Rust	<div style="display: flex; flex-wrap: wrap;"> <div style="width: 50%;"> <p>Corrosion</p>  <p>Outer ring of four-row tapered roller bearing</p> </div> <div style="width: 50%;">  <p>Outer ring of four-row tapered roller bearing</p> </div> <div style="width: 100%;"> <p>Rust</p>  <p>Outer ring of four-row tapered roller bearing</p> </div> </div>	<p>Rust, corrosion on the raceway surface at the same interval as rolling element spacing</p> <p>Rust on partial or entire surface of bearing</p>		<ol style="list-style-type: none"> 1) Worn or damaged seal lips 2) Ingress of water or corrosive materials into clearance between roll neck and sleeve <ol style="list-style-type: none"> 1) After the bearing was used, it has been left for a long period with moisture mixed in grease. 2) Improper rust preventive treatment after the bearing was washed. 	<ol style="list-style-type: none"> 1) Improve seal maintenance and sealing method. Periodically check for wear or damage on the seal lips. 2) Fit the "O" ring between the roll neck and the sleeve. <ol style="list-style-type: none"> 1) Immediately after the bearing is removed from the chock, change grease. 2) After washing the bearing, remove kerosene and water completely.

Table 7-1 (7) Bearing failures, causes and countermeasures



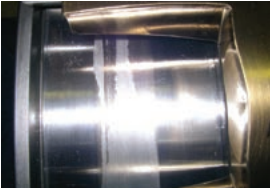
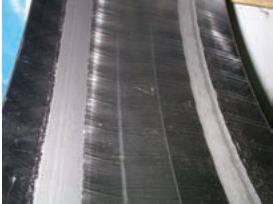





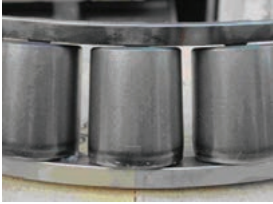

Failures	Characteristics	Damages		Causes	Countermeasures
(7) Creeping	 <p>Scuffing on rolling mill roll neck</p>  <p>Inner ring bore surface of four-row tapered roller bearing</p>	Wear, discoloration, and scuffing due to slip of fit surface		1) Insufficient grease or oil between the inner ring bore surface and the roll neck outside surface (When creep occurs between the inner ring and the roll neck, because of loose fit of them.)	1) Provide the spiral groove for bore surface of inner ring 2) When mounting the bearing, apply grease with molybdenum disulfide or EP grease. (Apply oil if the bearing is the oil lubricated type)
(8) Seizure	 <p>Rolling contact surface of double-row tapered roller bearing</p>  <p>Roller large end face of double-row tapered roller bearing</p>  <p>Inner ring of double-row tapered roller bearing</p>	Discoloration, deformation, and melting caused by heat of bearing		1) Improper lubrication (insufficient or degraded lubricant) 2) Ingress of water due to faulty sealing 3) Excessive axial load 4) Heat generated by creep of inner ring 5) Ingress of dusts or foreign matters 6) Excessively small bearing internal clearance	1) Reviewing sealing type and conditions 2) Reviewing lubricating method and lubricant, and checking lubricated condition 3) Check for axial load 4) Reviewing bearing (type, size, etc.) 5) Reviewing clearance 6) Confirming operating conditions

Table 7-1 (8) Bearing failures, causes and countermeasures

Failures	Characteristics	Damages	Causes	Countermeasures
(9) Failure in lubrication	 <p>Inner ring assembly of four-row tapered roller bearing</p>	Grease including large quantity of water mixed in	1) Operated at high temperature ⇒ Grease is carbonized. 2) Ingress of water due to improper sealing or wear or damage of seal lip (In this example, 20% or more of water is mixed in grease.)	1) Find the cause of high temperature. (If the temperature cannot be lowered, review the possibility of change to high temperature grease.) 2) Checking wear or damage of seal lip Find the cause of and countermeasure against the improper sealing.
	  <p>Inner ring assembly of double-row tapered roller bearing Outer ring of double-row tapered roller bearing</p>	Foreign matter attachment and corrosion occur because of ingress of a great deal of foreign matters (scale and water for rolling).	1) Ingress of water due to improper sealing or wear or damage of seal lip	1) Checking wear or damage of seal lip Find the cause of and countermeasure against the improper sealing.
	 <p>Four-row tapered roller bearing</p>	Seizure and adhesion of raceway, roller, and cage	1) Varied factors including improper lubrication, improper operation, and ingress of foreign matters occur, causing damages.	1) Checking improper operation 2) Checking lubricating conditions 3) Checking degradation of peripheral parts
	  <p>Outer ring assembly of four-row cylindrical roller bearing Outer ring assembly of four-row cylindrical roller bearing</p>	Looseness and breaking of pin	1) Abnormal load due to vibration occurs. 2) End of cage's service life because of use for a long period	1) Checking abnormal vibration 2) Replace if it has been used for a long period.

Bearing specification tables

Deep groove ball bearings

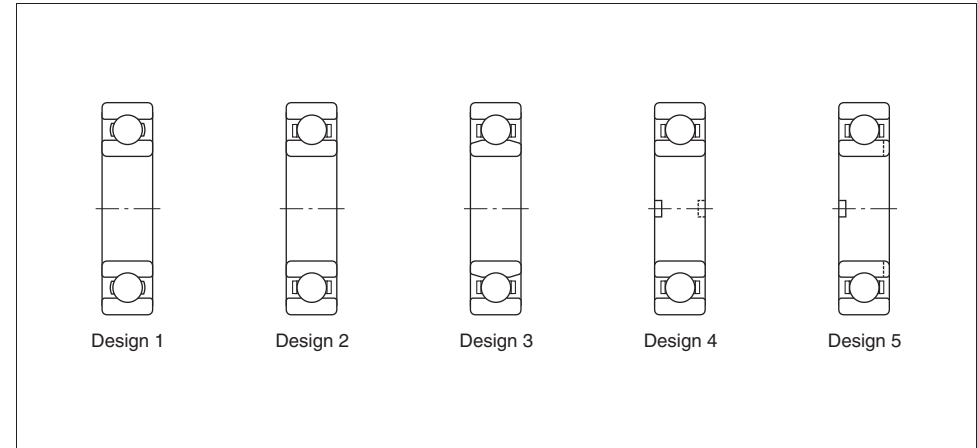

- Deep groove ball bearings can accommodate radial load and axial load in both directions.
- Suitable for operation at high speed, with low vibration.



Boundary dimensions	The dimensions of standard series are as specified in JIS B 1512.						
Tolerances	As specified in JIS B 1514, class 0 or 6 (refer to Table 2-2 on page 18.)						
Allowable misalignment	0.002 3 rad (8') – 0.003 4 rad (12')						
Radial internal clearance	(refer to Table 4-2 on page 50)						
Standard cages	Pressed cage (design 1) or machined cage (design 2 to 5).						
Equivalent radial load	Dynamic equivalent radial load $P_r = XF_r + YF_a$	$\frac{f_0 F_a}{C_{0r}}$	e	$\frac{F_a}{F_r} \leq e$		$\frac{F_a}{F_r} > e$	
	Static equivalent radial load $P_{0r} = 0.6F_r + 0.5F_a$ (when the value of $P_{0r} < F_r, P_{0r} = F_r$)			X	Y	X	Y
	0.172	0.19				2.30	
	0.345	0.22				1.99	
	0.689	0.26				1.71	
	1.03	0.28	1	0	0.56	1.55	
	1.38	0.30				1.45	
	2.07	0.34				1.31	
	3.45	0.38				1.15	
	5.17	0.42				1.04	
	6.89	0.44				1.00	

Factor f_0 is shown in the bearing specification table.

Single-row deep groove ball bearings

d 100 ~ 130 mm

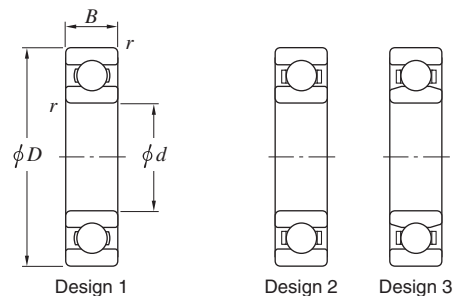

d 140 ~ (180) mm

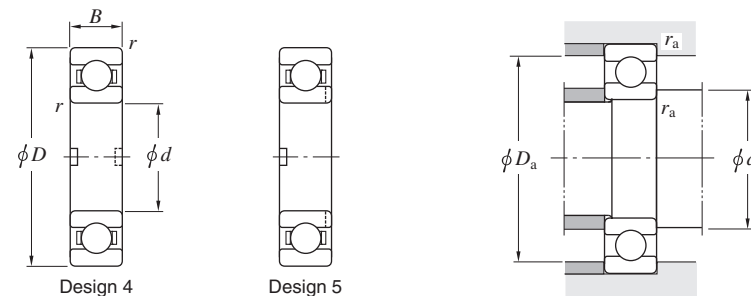

Boundary dimensions (mm)				Basic load ratings (kN)		Fatigue load limit (kN)	Factor	Bearing No.	De-sign	Mounting dimensions (mm)			(Refer.) Mass (kg)
d	D	B	$r_{min.}$	C_r	C_{0r}	C_u	f_0			d_a min.	D_a max.	r_a max.	
100	125	13	1	24.5	21.2	1.05	16.0	6820	1	105	120	1	0.309
	140	20	1.1	56.2	41.9	2.05	16.2	6920	2	106.5	133.5	1	0.960
	150	16	1	53.0	42.1	1.95	16.5	16020	1	105	145	1	0.910
	150	24	1.5	75.2	54.2	2.70	15.9	6020	1	108	142	1.5	1.25
	180	34	2.1	153	93.1	5.15	14.4	6220	1	111	169	2	3.14
	215	47	3	216	141	10.9	13.2	6320	1	113	202	2.5	7.00
105	145	20	1.1	58.1	44.8	2.10	16.4	6921	2	111.5	138.5	1	1.00
	160	18	1	52.3	42.2	1.90	16.5	16021	1	110	155	1	1.20
	160	26	2	90.4	65.8	3.20	15.8	6021	1	114	151	2	1.59
	190	36	2.1	166	105	5.70	14.4	6221	1	116	179	2	3.70
	225	49	3	230	153	11.7	13.2	6321	1	118	212	2.5	8.05
110	140	16	1	35.1	30.7	1.40	16.1	6822	1	115	135	1	0.606
	150	20	1.1	59.9	47.8	2.20	16.4	6922	2	116.5	143.5	1	1.04
	170	19	1	71.8	56.7	2.55	16.3	16022	1	115	165	1	1.46
	170	28	2	103	73.0	3.55	15.6	6022	1	119	161	2	1.96
	200	38	2.1	180	117	6.20	14.4	6222	1	121	189	2	4.36
	240	50	3	257	180	13.3	13.2	6322	1	123	227	2.5	9.54
120	150	16	1	36.2	33.0	1.45	16.0	6824	1	125	145	1	0.655
	165	22	1.1	71.6	56.9	2.50	16.4	6924	2	126.5	158.5	1	1.41
	180	19	1	79.0	63.3	2.75	16.4	16024	1	125	175	1	1.80
	180	28	2	106	79.3	3.60	15.9	6024	1	129	171	2	2.07
	215	40	2.1	194	131	6.65	14.4	6224	1	131	204	2	5.15
	260	55	3	258	185	12.6	13.5	6324	1	133	247	2.5	12.5
130	165	18	1.1	46.1	41.2	1.75	16.1	6826	1	136.5	158.5	1	0.939
	180	24	1.5	86.9	67.4	3.00	16.3	6926	2	138	172	1.5	1.86
	200	22	1.1	89.1	74.8	3.05	11.2	16026	1	136.5	193.5	1	2.69
	200	33	2	133	101	4.45	15.8	6026	1	139	191	2	3.16
	230	40	3	209	146	9.15	14.5	6226	1	143	217	2.5	5.82
	280	58	4	287	214	14.1	13.6	6326	1	146	264	3	15.1

Boundary dimensions (mm)				Basic load ratings (kN)		Fatigue load limit (kN)	Factor	Bearing No.	De-sign	Mounting dimensions (mm)			(Refer.) Mass (kg)
d	D	B	$r_{min.}$	C_r	C_{0r}	C_u	f_0			d_a min.	D_a max.	r_a max.	
140	175	18	1.1	47.8	44.4	1.85	16.0	6828	1	146.5	168.5	1	1.00
	190	24	1.5	89.1	74.8	3.05	16.5	6928	2	148	182	1.5	1.98
	210	22	1.1	82.2	71.1	2.80	16.5	16028	1	146.5	203.5	1	2.86
	210	33	2	137	109	4.55	15.9	6028	1	149	201	2	3.55
	250	42	3	208	150	8.65	14.8	6228	1	153	237	2.5	7.45
	300	62	4	316	246	15.6	13.6	6328	1	156	284	3	19.4
150	190	20	1.1	59.7	54.9	2.20	16.1	6830	1	156.5	183.5	1	1.40
	210	28	2	117	94.3	3.75	16.2	6930	2	159	201	2	3.05
	225	24	1.1	114	99.3	3.70	16.6	16030	2	156.5	218.5	1	3.58
	225	35	2.1	157	126	5.10	16.0	6030	1	161	214	2	4.22
	230	35	2.1	156	116	4.75	15.8	306891A	2	161	219	2	5.50
	270	45	3	220	168	9.05	15.1	6230	1	163	257	2.5	9.41
	320	65	4	343	284	16.6	13.9	6330	2	166	304	3	26.2
160	200	20	1.1	60.5	56.9	2.20	16.1	6832	1	166.5	193.5	1	1.45
	220	28	2	120	101	3.85	16.4	6932	2	169	211	2	3.20
	229.5	33	2	124	108	3.95	16.5	SB322333A	2	169	220.5	2	4.2
	240	25	1.5	124	108	3.95	16.5	16032	2	168	232	1.5	4.25
	240	38	2.1	171	135	5.30	15.9	6032	1	171	229	2	5.22
	290	48	3	231	186	9.45	15.4	6232	2	173	277	2.5	14.3
	340	68	4	347	286	16.4	13.9	6332	2	176	324	3	29.0
170	215	22	1.1	74.8	70.5	2.60	16.1	6834	1	176.5	208.5	1	1.90
	230	28	2	124	108	3.95	16.5	6934	2	179	221	2	3.35
	249.5	38	2	169	137	5.15	16.1	SB342538	2	179	240.5	2	6.00
	260	28	1.5	142	127	4.45	16.5	16034	2	178	252	1.5	5.75
	260	42	2.1	201	161	6.20	15.8	6034	1	181	249	2	6.80
	310	52	4	265	223	11.1	15.3	6234	2	186	294	3	17.5
360	72	4	408	355	20.5	13.6	6334	2	186	344	3	38.6	
180	225	22	1.1	75.8	73.1	2.65	16.1	6836	1	186.5	218.5	1	2.00

Single-row deep groove ball bearings

d (180) ~ (220) mm

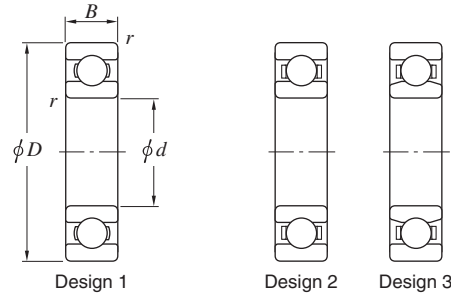

d (220) ~ (280) mm

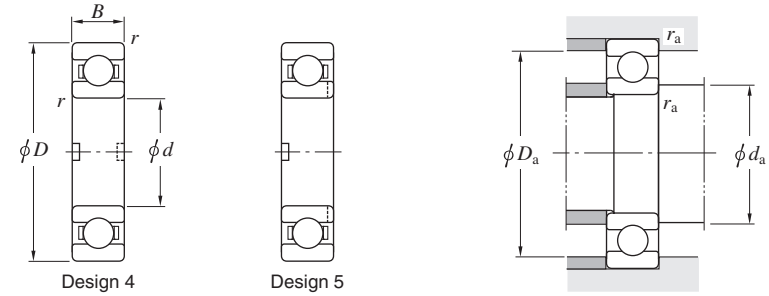

Boundary dimensions (mm)				Basic load ratings (kN)		Fatigue load limit (kN)	Factor	Bearing No.	De-sign	Mounting dimensions (mm)			(Refer.) Mass (kg)	
d	D	B	r min.	C_r	C_{0r}	C_u	f_0			d_a min.	D_a max.	r_a max.		
180	250	33	2	153	129	4.70	16.3	6936	2	189	241	2	4.90	
	259.5	33	2	142	127	4.45	16.5	306840	2	189	250.5	2	6.10	
	265	33	2	175	147	5.30	16.2	SB3627	2	189	256	2	6.20	
	280	31	2	169	148	5.15	16.4	16036	2	189	271	2	7.55	
	280	46	2.1	227	194	7.15	15.8	6036	2	191	269	2	10.3	
	320	52	4	284	241	12.0	15.1	6236	2	196	304	3	18.3	
	380	75	4	443	407	22.1	13.9	6336	2	196	364	3	44.7	
	190	240	24	1.5	91.4	88.1	3.10	16.1	6838	1	198	232	1.5	2.60
259.5		33	2	141	127	4.35	16.6	SB382633	2	199	250.5	2	5.10	
260		33	2	158	138	4.85	16.4	6938	2	199	251	2	5.20	
269.5		33	2	174	148	5.25	16.3	306627A	2	199	260.5	2	6.50	
290		31	2	173	158	5.20	16.6	16038	2	199	281	2	7.85	
290		46	2.1	235	201	7.35	15.8	6038	2	201	279	2	10.8	
340		55	4	319	281	13.7	15.0	6238	2	206	324	3	23.0	
400		78	5	443	415	21.3	14.1	6338	2	210	380	4	51.5	
200		250	24	1.5	97.6	93.6	3.20	16.1	6840	2	208	242	1.5	2.70
		279.5	38	2.1	179	158	5.35	16.4	360278	2	211	268.5	2	7.40
	280	38	2.1	196	168	5.80	16.2	6940	2	211	269	2	7.30	
	289.5	38	2.1	206	176	6.10	16.1	306841	2	211	278.5	2	8.90	
	310	34	2	201	180	5.95	16.4	16040	2	209	301	2	10.1	
	310	51	2.1	272	243	11.3	15.6	6040	2	211	299	2	14.0	
	360	58	4	336	311	14.4	15.2	6240	2	216	344	3	28.2	
	420	80	5	513	506	25.5	14.0	6340	2	220	400	4	58.0	
	210	299.5	38	2.1	213	189	6.35	16.2	SB4230	2	221	288.5	2	8.80
	220	270	24	1.5	101	101	3.35	16.0	6844	2	228	262	1.5	3.00
300		38	2.1	201	180	5.85	16.4	6944	2	231	289	2	7.90	
309.5		38	2.1	188	178	5.65	16.5	306867	2	231	298.5	2	9.40	
319.5		46	2.1	241	220	7.30	16.1	SB4432A	2	231	308.5	2	11.9	

Boundary dimensions (mm)				Basic load ratings (kN)		Fatigue load limit (kN)	Factor	Bearing No.	De-sign	Mounting dimensions (mm)			(Refer.) Mass (kg)
d	D	B	r min.	C_r	C_{0r}	C_u	f_0			d_a min.	D_a max.	r_a max.	
220	340	37	2.1	225	217	6.65	16.5	16044	2	231	329	2	13.2
	340	56	3	294	271	12.0	15.6	6044	2	233	327	2.5	18.3
	400	65	4	389	376	16.8	15.1	6244	2	236	384	3	37.0
	460	88	5	542	539	26.7	13.8	6344	2	240	440	4	71.6
	230	329.5	40	2.1	229	213	6.75	16.3	306842A	2	241	318.5	2
339.5		45	3	279	267	11.1	16	SB4634	2	243	326.5	2.5	13.6
240	300	28	2	135	135	4.25	16.1	6848	2	249	291	2	4.50
	320	38	2.1	205	192	5.95	16.5	6948	2	251	309	2	8.50
	329.5	40	2.1	217	205	6.30	16.5	SB4833	2	251	318.5	2	9.80
	360	37	2.1	230	228	6.75	16.5	16048	2	251	349	2	14.1
	360	56	3	305	296	12.3	15.9	6048	2	253	347	2.5	19.7
	440	72	4	424	431	18.2	15.2	6248	2	256	424	3	51.0
	500	95	5	587	624	28.2	14.2	6348	2	260	480	4	93.3
250	340	42	2.1	210	202	6.05	16.5	SB5034A	2	261	329	2	10.8
	349.5	46	2.1	246	238	7.25	16.4	SB5035	2	261	338.5	2	13.1
260	320	28	2	141	146	4.40	16.0	6852	2	269	311	2	4.80
	360	46	2.1	266	263	10.2	16.3	6952	2	271	349	2	14.4
	369.5	46	2.1	287	289	11.2	16.2	306862	2	271	358.5	2	16.0
	379.5	56	3	316	321	12.6	16.1	SB5238	2	273	366.5	2.5	20.3
	400	44	3	295	310	11.5	16.4	16052	2	273	387	2.5	21.6
	400	65	4	364	377	15.0	15.8	6052	2	276	384	3	29.3
	480	80	5	502	541	22.2	15.1	6252	2	280	460	4	68.2
	270	379.5	46	2.1	285	290	11.0	16.3	SB5438	2	281	368.5	2
280	350	33	2	179	183	5.35	16.1	6856	2	289	341	2	7.40
	380	46	2.1	273	283	10.5	16.5	6956	2	291	369	2	15.1
	389.5	46	2.1	295	310	11.5	16.4	306861A	2	291	378.5	2	18.0
	420	44	3	302	331	11.7	14.7	16056	2	293	407	2.5	22.9

Single-row deep groove ball bearings

d (280) ~ 340 mm

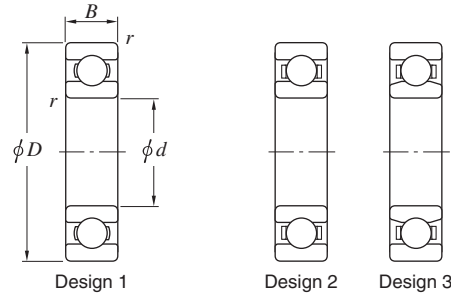

d 360 ~ (460) mm

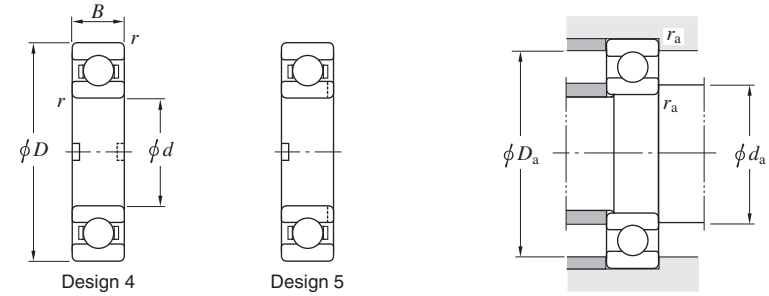

Boundary dimensions (mm)				Basic load ratings (kN)		Fatigue load limit (kN) C_u	Factor f_0	Bearing No.	De-sign	Mounting dimensions (mm)			(Refer.) Mass (kg)
d	D	B	$r_{min.}$	C_r	C_{0r}					d_a min.	D_a max.	r_a max.	
280	420	65	4	377	408	15.5	16.0	6056	2	296	404	3	31.0
	500	80	5	529	599	23.2	15.3	6256	2	300	480	4	71.8
290	400	52	4	293	311	11.3	16.5	SB5840	2	306	384	3	19.6
	409.5	56	3	324	347	12.8	16.3	SB5841	2	303	396.5	2.5	22.2
	419.5	60	4	346	377	13.8	16.2	SB584260	2	306	403.5	3	26.5
300	380	38	2.1	224	230	6.45	16.2	6860	2	311	369	2	10.5
	419.5	56	3	323	349	12.5	16.4	SB604256	2	313	406.5	2.5	22.9
	420	56	3	345	377	13.7	16.2	6960	2	313	407	2.5	24.1
	429.5	56	3	322	350	12.4	16.4	SB6043	2	313	416.5	2.5	26.7
	460	50	4	355	405	14.0	16.4	16060	2	316	447	3	32.2
460	74	4	444	482	18.4	15.6	6060	2	316	444	3	44.0	
310	429.5	60	4	344	379	13.5	16.3	SB624360	2	326	413.5	3	25.3
320	400	38	2.1	227	239	6.50	16.1	6864	2	331	389	2	11.0
	440	56	3	356	404	14.1	16.4	6964	2	333	427	2.5	25.5
	449.5	56	3	364	411	14.3	16.3	SB6445A	2	333	436.5	2.5	26.4
	480	50	4	364	432	14.3	16.5	16064	2	336	467	3	33.9
480	74	4	441	487	17.8	15.7	6064	2	336	464	3	46.0	
330	459.5	56	3	377	439	15.0	16.4	SB6646	2	343	446.5	2.5	28.4
340	420	38	2.1	231	249	6.60	16.1	6868	2	351	409	2	11.5
	449.5	56	3	352	407	13.7	16.5	SB684556	2	353	436.5	2.5	22.9
	460	56	3	352	407	13.7	16.5	6968	2	353	447	2.5	26.8
	479.5	65	3	413	480	16.5	16.2	SB6848	2	353	466.5	2.5	35.5
	489.5	60	5	412	481	16.3	16.2	SB6849	2	360	469.5	4	36.4
	520	57	4	419	512	16.8	16.4	16068	2	356	507	3	46.8
	520	82	5	552	661	23.7	15.6	6068	2	360	500	4	61.8
	540	90	5	578	679	24.8	15.4	SB6854	2	360	520	4	77.2
	620	92	6	639	817	27.7	15.6	6268	2	364	596	5	131
710	118	7.5	880	1160	41.7	14.7	6368	2	372	678	6	238	

Boundary dimensions (mm)				Basic load ratings (kN)		Fatigue load limit (kN) C_u	Factor f_0	Bearing No.	De-sign	Mounting dimensions (mm)			(Refer.) Mass (kg)
d	D	B	$r_{min.}$	C_r	C_{0r}					d_a min.	D_a max.	r_a max.	
360	440	38	2.1	240	268	6.95	16.0	6872	2	371	429	2	12.0
	480	56	3	362	432	14.0	16.5	6972	2	373	467	2.5	28.2
	509.5	70	5	455	550	18.4	16.2	SB725170	2	380	489	4	42.7
	540	57	4	431	546	17.2	16.5	16072	2	376	527	3	49.0
	540	82	5	548	668	23.0	15.7	6072	2	380	520	4	64.7
550	85	5	547	669	22.9	15.8	SB7255	2	380	530	4	71.9	
380	480	46	2.1	305	359	8.95	16.2	6876	2	391	469	2	20.0
	520	65	4	440	552	17.6	16.4	6976	2	396	504	3	40.8
	560	82	5	572	725	24.1	15.9	6076	2	400	540	4	67.6
400	500	46	2.1	311	374	9.10	16.1	6880	2	411	489	2	20.5
	540	65	4	453	588	18.1	16.5	6980	2	416	524	3	42.7
	600	63	5	447	587	17.5	16.5	16080	2	420	580	4	65.0
	600	90	5	635	824	27.0	15.7	6080	2	420	580	4	87.7
720	130	6	785	1080	34.2	15.5	SB8072A	4	424	696	5	232	
420	520	46	2.1	316	389	9.25	16.1	6884	2	431	509	2	21.5
	560	65	4	449	588	17.7	16.5	6984	2	436	544	3	43.5
	620	90	5	663	894	28.3	15.8	6084	2	440	600	4	91.2
430	600	75	4	510	678	20.2	16.4	SB8660	2	446	584	3	64.6
440	540	46	2.1	321	404	9.40	16.0	6888	2	451	529	2	22.5
	600	74	4	529	676	21.4	16.4	6988	2	456	584	3	61.3
	619	75	4	527	724	21.1	16.5	SB8862A	2	456	603	3	70.3
	650	67	5	508	710	20.2	16.5	16088	2	460	630	4	81.7
	650	94	6	658	902	27.5	16	6088	2	464	626	5	105
450	630	75	4	509	711	20.3	16.5	SB9063	2	466	614	3	72
460	580	56	3	393	517	11.7	16.2	6892	2	473	567	2.5	35.0
	620	74	4	509	711	20.3	16.5	6992	2	476	604	3	61.7
	659	80	4	605	854	24.6	16.3	SB9266	2	476	643	3	90

Single-row deep groove ball bearings

d (460) ~ (670) mm

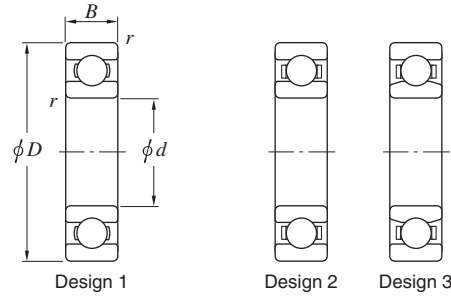

d (670) ~ 1 000 mm

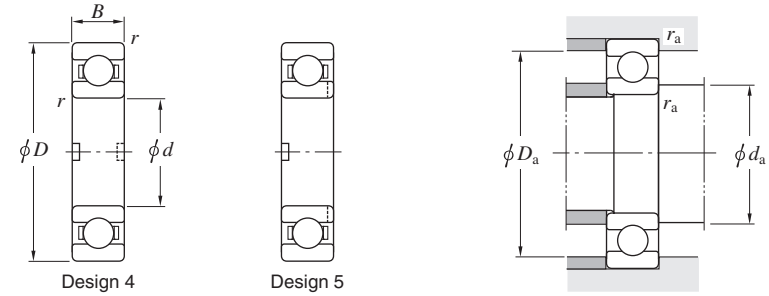

Boundary dimensions (mm)				Basic load ratings (kN)		Fatigue load limit (kN) C_u	Factor f_0	Bearing No.	De- sign	Mounting dimensions (mm)			(Refer.) Mass (kg)
d	D	B	$r_{min.}$	C_r	C_{0r}					d_a min.	D_a max.	r_a max.	
460	680	71	5	539	767	21.4	16.5	16092	2	480	660	4	91.2
	680	100	6	722	1 000	30.4	15.8	6092	2	484	656	5	124
480	600	56	3	401	539	12.0	16.1	6896	2	493	587	2.5	36.5
	700	100	6	754	1 090	32.0	15.9	6096	2	504	676	5	127
500	620	56	3	409	561	12.2	16.1	68/500	2	513	607	2.5	37.5
	670	78	5	556	807	22.2	16.5	69/500	2	520	650	4	75.2
	720	100	6	749	1 100	31.3	16.0	60/500	2	524	696	5	128
520	679.5	78	3	571	848	23.0	16.4	SB520-1	2	533	666.5	2.5	72.2
530	650	56	3	414	581	12.4	16.0	68/530	2	543	637	2.5	39.5
	710	82	5	640	975	26.0	16.6	69/530	2	550	690	4	89.2
	760	100	6	777	1 180	32.4	16.2	SB530	2	554	736	5	144
560	680	56	3	420	602	12.5	16.0	68/560	2	573	667	2.5	42.0
	820	115	6	954	1 520	41.4	15.9	60/560	2	584	796	5	199
570	799	115	6	801	1 280	33.3	16.3	SB570	2	594	775	5	172
590	820	105	6	796	1 280	32.7	16.4	SB590A	2	614	796	5	166
600	730	60	3	471	707	14.2	16.0	68/600	2	613	717	2.5	52.0
	800	90	5	668	1 200	26.9	16.4	69/600	2	620	780	4	127
610	720	55	3	378	559	14.4	15.7	SB610D	2	623	707	2.5	38.8
	730	54	3	377	559	14.3	15.7	SB610A	3	623	717	2.5	42.3
	849.5	100	6	823	1 370	34.0	16.5	SB610C	2	634	825.5	5	172
	869	120	5	907	1 520	38.2	16.3	SB610B	5	630	849	4	221
630	780	69	4	558	875	17.0	16.1	68/630	2	646	767	3	69.0
	920	128	7.5	1 050	1 770	45.0	16.0	60/630	2	662	888	6	276
670	820	69	4	565	908	17.2	16.0	68/670	2	686	807	3	76.9

Boundary dimensions (mm)				Basic load ratings (kN)		Fatigue load limit (kN) C_u	Factor f_0	Bearing No.	De- sign	Mounting dimensions (mm)			(Refer.) Mass (kg)
d	D	B	$r_{min.}$	C_r	C_{0r}					d_a min.	D_a max.	r_a max.	
670	980	136	7.5	1 090	1 920	46.4	16.2	60/670	2	702	948	6	337
700	979	150	6	1 050	1 900	44.4	16.4	SB700	5	724	955	5	326
710	870	74	4	619	1 030	19.0	16.0	68/710	2	726	854	3	93.8
	1 030	140	7.5	1 270	2 310	55.7	16.0	60/710	2	742	998	6	394
	1 080	160	7.5	1 320	2 490	58.2	16.1	SB710	2	742	1 048	6	524
730	900	78	5	595	1 010	23.5	15.9	SB730	3	750	880	4	105
750	920	78	5	642	1 110	19.9	15.9	68/750	2	770	900	4	111
	1 090	150	7.5	1 320	2 500	57.6	16.1	60/750	2	782	1 058	6	473
800	980	82	5	730	1 310	22.6	16.0	68/800	2	820	960	4	127
	1 150	155	7.5	1 360	2 690	59.2	16.3	60/800	2	832	1 118	6	533
830	1 080	115	6	994	1 900	40.8	16.3	SB830	4	854	1 056	5	275
850	1 030	82	5	738	1 350	22.8	15.9	68/850	2	870	1 010	4	135
	1 120	118	6	1 130	2 240	47.4	16.4	69/850	2	874	1 096	5	315
	1 178	160	7.5	1 350	2 710	57.7	16.4	SB850A	2	882	1 146	6	524
880	1 130	115	6	1 010	1 980	41.5	16.2	SB880	2	904	1 106	5	265
900	1 090	85	5	764	1 450	23.8	15.9	68/900	2	920	1 070	4	162
	1 180	122	6	1 110	2 220	45.9	16.3	69/900	2	924	1 156	5	347
920	1 180	120	6	1 030	2 070	42.4	16.2	SB920	2	944	1 156	5	320
930	1 010	40	2.1	273	494	8.70	14.3	SB930A	2	946	994	2	31
950	1 150	90	5	876	1 740	27.7	15.9	68/950	2	970	1 130	4	190
	1 250	132	7.5	1 240	2 580	51.8	16.3	69/950	2	982	1 218	6	431
1 000	1 220	100	6	987	2 030	31.4	16.0	68/1000	2	1 024	1 196	5	245
	1 380	190	7.5	1 460	3 220	62.2	16.4	SB1000	2	1 032	1 348	6	837

Single-row deep groove ball bearings

d 1 060 ~ 1 420 mm

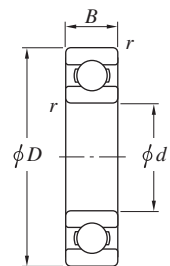

Design 1



Design 2



Design 3

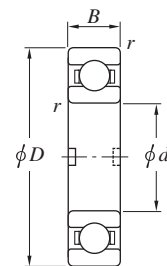

Design 4

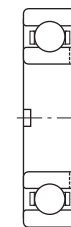

Design 5

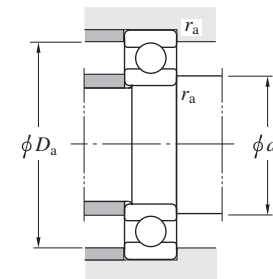

Boundary dimensions (mm)				Basic load ratings (kN)		Fatigue load limit (kN) C_u	Factor f_0	Bearing No.	De- sign	Mounting dimensions (mm)			(Refer.) Mass (kg)
d	D	B	$r_{min.}$	C_r	C_{0r}					d_a min.	D_a max.	r_a max.	
1 060	1 280	100	6	998	2 100	31.7	15.9	68/1060	2	1 084	1 256	5	251
1 090	1 350	122	7.5	1 110	2 410	45.9	16	SB1090	2	1 122	1 318	6	376
1 100	1 200	50	2.1	395	744	12.1	14.2	SB1100A	2	1 116	1 184	2	56
1 120	1 360	106	6	834	1 790	26.2	15.6	68/1120	2	1 144	1 336	5	319
1 200	1 450	112	7.5	1 140	2 580	47.1	15.8	SB1200	2	1 232	1 418	6	363
1 240	1 510	122	7.5	1 260	2 930	52.5	15.9	SB1240	2	1 272	1 478	6	446
1 320	1 600	122	6	1 300	3 130	42.4	15.9	68/1320	2	1 344	1 576	5	504
1 400	1 700	132	7.5	1 310	3 510	42.4	15.8	68/1400	2	1 432	1 668	6	621
1 420	1 800	150	9.5	1 440	3 630	60.1	15.8	SB1400B	2	1 460	1 760	8	915

Angular contact ball bearings



■ Single-row, matched pair (page 104)

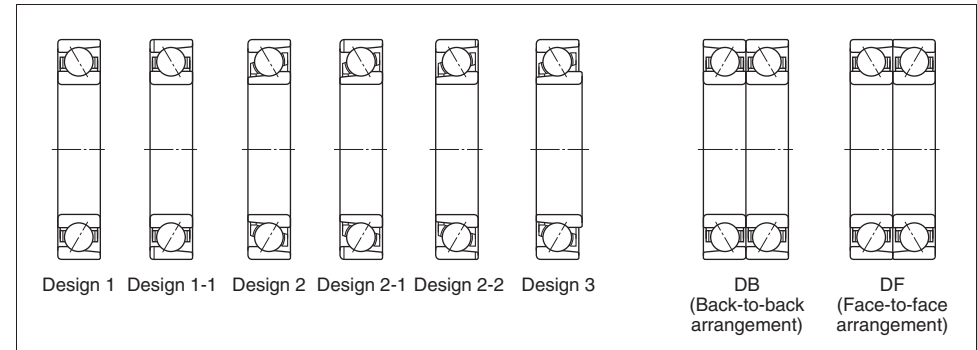

■ Double-row (page 116)

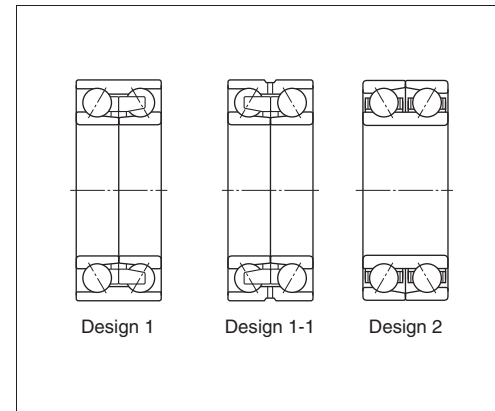

- Single-row bearings can accommodate radial load and axial load in one direction.
- DB and DF matched pair bearings and double-row bearings can accommodate radial load and axial load in both directions.
- Two or more single-row angular contact ball bearings are often combined in order to increase the load rating or rigidity. In this case, two types of arrangements, back-to-back arrangement (DB) and face-to-face arrangement (DF), are available. If the load rating of a single-row angular contact ball bearing is insufficient, use the tandem arrangement (DT).

Boundary dimensions	The dimensions of standard series are as specified in JIS B 1512-1995.
Tolerances	As specified in JIS B 1514, class 0 or 6. (refer to Table 2-2 on page 18.)
Contact angle (α)	The standard contact angles are 15°, 30° and 40°. Bearings with a smaller contact angle are more suitable for applications involving high-speed rotation. Those with a larger contact angle feature superior axial load resistance. (The standard contact angles of single-row and matched pair angular contact ball bearings) 15°.....supplementary code C 30°.....supplementary code A or no indication 40°.....supplementary code B [Note] Contact angles of double-row angular contact ball bearings are shown in specification tables.
Allowable misalignment	Single-row.....0.000 6 rad (2') : Matched pair, double-row.....misalignment not allowed
Internal clearance	(refer to Table 4-3 on pages 50 and 51)
Standard cages	Machined cage

Equiv- alent radial load	Single- row and matched pair angular contact ball bearings	Dynamic equivalent radial load $P_r = XF_r + YF_a$	Contact angle	$\frac{if_0F_a}{C_{0r}}$	e	Single-row and tandem (DT) arrangement			Back-to-back (DB) and face-to-face (DF) arrangement				
						$\frac{F_a}{F_r} \leq e$		$\frac{F_a}{F_r} > e$	$\frac{F_a}{F_r} \leq e$		$\frac{F_a}{F_r} > e$		
						X	Y	X	Y	X	Y	X	Y
			$\alpha = 15^\circ$	0.178	0.38				1.47	1.65	2.39		
				0.357	0.40				1.40	1.57	2.28		
				0.714	0.43				1.30	1.46	2.11		
				1.07	0.46	1	0	0.44	1.23	1.38	2.00		
				1.43	0.47				1.19	1.34	1.93		
				2.14	0.50				1.12	1.26	1.82		
			3.57	0.55				1.02	1.14	1.66			
			5.35	0.56				1.00	1.12	1.63			
			$\alpha = 30^\circ$	-	0.80	1	0	0.39	0.76	1	0.78	0.63	1.24
			$\alpha = 40^\circ$	-	1.14	1	0	0.35	0.57	1	0.55	0.57	0.93

For i , use 2 for DB & DF and 1 for single & DT.
Factor f_0 is shown in the bearing specification table.

Contact angle	Single-row and tandem (DT) arrangement		Back-to-back (DB) and face-to-face (DF) arrangement	
	X_0	Y_0	X_0	Y_0
$\alpha = 15^\circ$	0.5	0.46	1	0.92
$\alpha = 30^\circ$	0.5	0.33	1	0.66
$\alpha = 40^\circ$	0.5	0.26	1	0.52

Static equivalent radial load
 $P_{0r} = X_0F_r + Y_0F_a$
(In reference to single-row and tandem arrangement bearings, when $P_{0r} < F_r$
 $P_{0r} = F_r$)

Contact angle	e	$\frac{F_a}{F_r} \leq e$		$\frac{F_a}{F_r} > e$	
		X	Y	X	Y
$\alpha = 30^\circ$	0.80	1	0.78	0.63	1.24
$\alpha = 32^\circ$	0.86	1	0.73	0.62	1.17

Contact angle	X_0	Y_0
$\alpha = 30^\circ$	1	0.66
$\alpha = 32^\circ$	1	0.63

Static equivalent radial load
 $P_{0r} = X_0F_r + Y_0F_a$

Dynamic equivalent load calculation : when a pair of single-row angular contact ball bearings is arranged face-to-face or back-to-back.

While radial loads F_{rA} and F_{rB} are applied to bearings A and B, axial load K_a externally acts in the directions shown in the figures below.

[Remark]

When radial load is applied to a single-row angular contact ball bearing, axial load generated as an axial component of force acts on another bearing. The axial load can be obtained by the following equation.

$$F_a = \frac{F_r}{2Y}$$

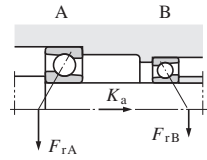
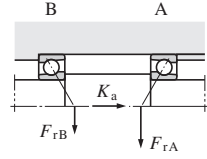
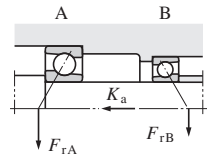
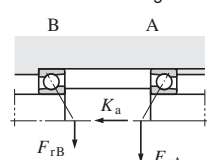
Paired mounting	Loading condition	Bearing	Axial load	Dynamic equivalent load
Back-to-back arrangement 	$\frac{F_{rB}}{2Y_B} + K_a \geq \frac{F_{rA}}{2Y_A}$	Bearing A	$\frac{F_{rB}}{2Y_B} + K_a$	$P_A = XF_{rA} + Y_A \left(\frac{F_{rB}}{2Y_B} + K_a \right)$ $P_A = F_{rA}$, where $P_A < F_{rA}$
		Bearing B	-	$P_B = F_{rB}$
Face-to-face arrangement 	$\frac{F_{rB}}{2Y_B} + K_a < \frac{F_{rA}}{2Y_A}$	Bearing A	-	$P_A = F_{rA}$
		Bearing B	$\frac{F_{rA}}{2Y_A} - K_a$	$P_B = XF_{rB} + Y_B \left(\frac{F_{rA}}{2Y_A} - K_a \right)$ $P_B = F_{rB}$, where $P_B < F_{rB}$
Back-to-back arrangement 	$\frac{F_{rB}}{2Y_B} \leq \frac{F_{rA}}{2Y_A} + K_a$	Bearing A	-	$P_A = F_{rA}$
		Bearing B	$\frac{F_{rA}}{2Y_A} + K_a$	$P_B = XF_{rB} + Y_B \left(\frac{F_{rA}}{2Y_A} + K_a \right)$ $P_B = F_{rB}$, where $P_B < F_{rB}$
Face-to-face arrangement 	$\frac{F_{rB}}{2Y_B} > \frac{F_{rA}}{2Y_A} + K_a$	Bearing A	$\frac{F_{rB}}{2Y_B} - K_a$	$P_A = XF_{rA} + Y_A \left(\frac{F_{rB}}{2Y_B} - K_a \right)$ $P_A = F_{rA}$, where $P_A < F_{rA}$
		Bearing B	-	$P_B = F_{rB}$

- [Remarks] 1. These equations can be used when internal clearance and preload during operation are zero.
2. Radial load is treated as positive in the calculation, if it is applied in a direction opposite that shown in Fig. above

Single-row, matched pair angular contact ball bearings

d 100 ~ (130) mm

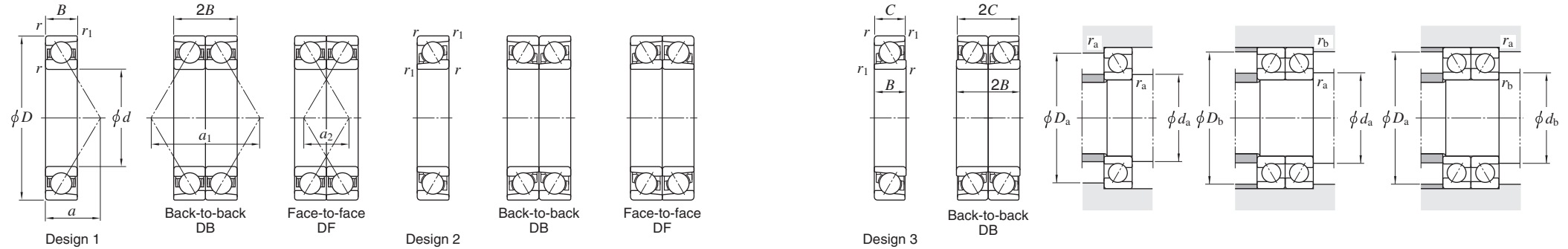

Boundary dimensions (mm)					Basic load ratings (kN)				Fatigue load limit (kN)		Single row	Bearing No.		De-sign	Load center (mm)			Mounting dimensions (mm)				(Refer.) Mass Single row (kg)			
d	D	B	C	r min.	r_1 min.	C_r	C_{0r}	C_r	C_{0r}	C_u (Single row) (Matched pair)		Back-to-back DB	Face-to-face DF		a	a_1	a_2	d_a min.	d_b min.	D_a max.	D_b max.		r_a max.	r_b max.	
100	150	24	—	1.5	1	85.5	70.6	139	141	3.35	6.75	7020	7020DB	7020DF	1	48.1	96.2	48.2	108.5	—	141.5	144.5	1.5	1	1.37
	150	24	—	1.5	1	76.5	63.6	124	127	2.95	5.90	7020B	7020BDB	7020BDF	1	64.4	128.9	80.9	108.5	—	141.5	144.5	1.5	1	1.37
	180	34	—	2.1	1.1	171	117	279	235	6.10	12.2	7220	7220DB	7220DF	1	57.7	115.4	47.4	112	—	168	173	2	1	3.32
	180	34	—	2.1	1.1	155	107	252	214	5.25	10.5	7220B	7220BDB	7220BDF	1	76.2	152.3	84.3	112	—	168	173	2	1	3.32
	215	47	—	3	1.1	229	161	373	323	6.60	13.2	7320	7320DB	7320DF	1	69.4	138.8	44.8	114	—	201	208	2.5	1	7.53
	215	47	—	3	1.1	210	148	342	297	6.10	12.2	7320B	7320BDB	7320BDF	1	90.2	180.4	86.4	114	—	201	208	2.5	1	7.53
105	160	26	—	2	1	99.7	81.9	162	164	3.80	7.60	7021	7021DB	7021DF	1	51.8	103.7	51.7	115	—	150	154.5	2	1	1.73
	190	36	—	2.1	1.1	187	132	303	265	6.70	13.4	7221	7221DB	7221DF	1	61.0	122.1	50.1	117	—	178	183	2	1	3.95
	190	36	—	2.1	1.1	169	121	275	241	5.80	11.6	7221B	7221BDB	7221BDF	1	80.5	161.0	89.0	117	—	178	183	2	1	3.95
	225	49	—	3	1.1	260	193	422	386	7.75	15.5	7321	7321DB	7321DF	1	72.1	144.3	46.3	119	—	211	218	2.5	1	8.62
	225	49	—	3	1.1	238	177	387	355	7.15	14.3	7321B	7321BDB	7321BDF	1	93.7	187.5	89.5	119	—	211	218	2.5	1	8.62
110	170	28	—	2	1	115	92.8	187	186	4.30	8.55	7022	7022DB	7022DF	1	54.4	108.9	52.9	120	—	160	164.5	2	1	2.14
	170	28	—	2	1	103	83.7	167	167	3.75	7.45	7022B	7022BDB	7022BDF	1	72.7	145.5	89.5	120	—	160	164.5	2	1	2.14
	200	38	—	2.1	1.1	202	148	329	297	7.30	14.6	7222	7222DB	7222DF	1	64.3	128.7	52.7	122	—	188	193	2	1	4.65
	200	38	—	2.1	1.1	183	135	298	270	6.35	12.7	7222B	7222BDB	7222BDF	1	84.9	169.7	93.7	122	—	188	193	2	1	4.65
	240	50	—	3	1.1	290	226	472	452	8.75	17.5	7322	7322DB	7322DF	1	76.4	152.7	52.7	124	—	226	233	2.5	1	10.1
	240	50	—	3	1.1	266	208	433	416	8.05	16.1	7322B	7322BDB	7322BDF	1	99.6	199.3	99.3	124	—	226	233	2.5	1	10.1
120	180	28	—	2	1	121	103	196	206	4.50	9.00	7024	7024DB	7024DF	1	57.3	114.6	58.6	130	—	170	174.5	2	1	2.27
	180	28	—	2	1	108	93.0	176	186	3.95	7.85	7024B	7024BDB	7024BDF	1	76.9	153.9	97.9	130	—	170	174.5	2	1	2.27
	215	40	—	2.1	1.1	218	166	354	332	7.85	15.7	7224	7224DB	7224DF	1	68.5	137.0	57.0	132	—	203	208	2	1	5.49
	215	40	—	2.1	1.1	197	151	321	302	6.80	13.6	7224B	7224BDB	7224BDF	1	90.3	180.5	100.5	132	—	203	208	2	1	5.49
	260	55	—	3	1.1	308	252	500	504	9.45	18.9	7324	7324DB	7324DF	1	82.3	164.7	54.7	134	—	246	253	2.5	1	12.6
	260	55	—	3	1.1	282	231	457	462	8.65	17.3	7324B	7324BDB	7324BDF	1	107.2	214.4	104.4	134	—	246	253	2.5	1	12.6
130	200	33	—	2	1	147	125	238	251	5.25	10.5	7026	7026DB	7026DF	1	64.1	128.3	62.3	140	—	190	194.5	2	1	3.43
	200	33	—	2	1	131	113	213	226	4.60	9.20	7026B	7026BDB	7026BDF	1	85.7	171.5	105.5	140	—	190	194.5	2	1	3.43
	230	40	—	3	1.1	245	198	398	395	7.60	15.2	7226	7226DB	7226DF	1	72.0	143.9	63.9	144	—	216	223	2.5	1	6.21
	230	40	—	3	1.1	222	180	360	360	6.95	13.9	7226B	7226BDB	7226BDF	1	95.5	191.0	111.0	144	—	216	223	2.5	1	6.21
	280	58	—	4	1.5	376	329	611	659	11.8	23.7	7326	7326DB	7326DF	1	88.8	177.5	61.5	148	—	262	271.5	3	1.5	15.4

[Remark] a_1, a_2 : Load center spread

Single-row, matched pair angular contact ball bearings

d (130) ~ (160) mm

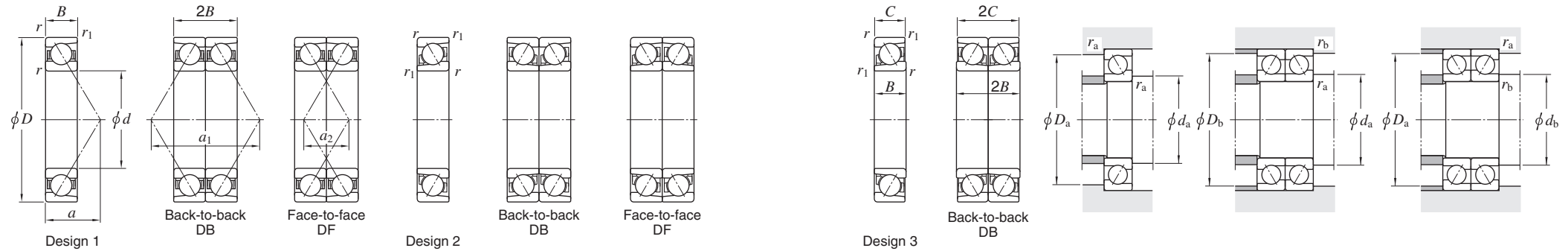

Boundary dimensions (mm)					Basic load ratings (kN)				Fatigue load limit (kN)		Single row	Bearing No.		De-sign	Load center (mm)			Mounting dimensions (mm)					(Refer.) Mass Single row (kg)	
d	D	B	C	r min.	r_1 min.	C_r	C_{0r}	C_r	C_{0r}	C_u (Single row) (Matched pair)		Back-to-back DB	Face-to-face DF		a	a_1	a_2	d_a min.	d_b min.	D_a max.	D_b max.	r_a max.		r_b max.
130	280	58	—	4	1.5	312	268	507	536	9.70 19.4	7326B	7326BDB	7326BDF	1	115.0	230.0	114.0	148	—	262	271.5	3	1.5	15.4
140	190	24	—	1.5	1	99.7	93.0	162	186	3.75 7.50	7928	7928DB	7928DF	1	59.6	119.3	71.3	148.5	—	181.5	184.5	1.5	0.8	1.90
	190	24	—	1.5	1	88.8	81.0	144	163	3.25 6.55	7928B	7928BDB	7928BDF	1	81.2	162.5	114.5	148.5	—	181.5	184.5	1.5	0.8	1.80
	210	33	—	2	1	150	133	243	265	5.30 10.6	7028	7028DB	7028DF	1	67.0	134.1	68.1	150	—	200	204.5	2	1	3.64
	210	33	—	2	1	134	119	217	237	4.65 9.25	7028B	7028BDB	7028BDF	1	89.9	179.8	113.8	150	—	200	204.5	2	1	3.64
	250	42	—	3	1.1	273	234	443	468	8.65 17.3	7228	7228DB	7228DF	1	77.3	154.6	70.6	154	—	236	243	2.5	1	7.76
	250	42	—	3	1.1	247	213	401	426	7.85 15.7	7228B	7228BDB	7228BDF	1	102.8	205.6	121.6	154	—	236	243	2.5	1	7.76
	300	62	—	4	1.5	411	374	668	748	13.0 26.1	7328	7328DB	7328DF	1	94.5	189.0	65.0	158	—	282	291.5	3	1.5	18.8
	300	62	—	4	1.5	378	344	613	688	12.0 24.0	7328B	7328BDB	7328BDF	1	123.3	246.6	122.6	158	—	282	291.5	3	1.5	18.8
145	220	38	—	2.1	1.1	167	146	271	292	5.60 11.2	AC2922	AC2922DB	AC2922DF	1	71.7	143.4	67.4	157	—	208	213	2	1	4.82
150	210	28	—	2	1	134	125	218	250	4.80 9.60	7930	7930DB	7930DF	1	66.0	131.9	75.9	160	—	200	204.5	2	1	2.90
	210	28	—	2	1	120	109	194	218	4.20 8.40	7930B	7930BDB	7930BDF	1	89.5	179.0	123.0	160	—	200	204.5	2	1	2.90
	210	25	28	2	1	120	109	194	218	4.20 8.40	AC3021B	AC3021BDB	—	3	88	176	—	160	—	200	204.5	2	1	2.73
	225	35	—	2.1	1.1	171	154	278	308	5.95 11.9	7030	7030DB	7030DF	1	72.1	144.2	74.2	162	—	213	218	2	1	4.43
	225	35	—	2.1	1.1	153	138	249	275	5.20 10.4	7030B	7030BDB	7030BDF	1	96.2	192.3	122.3	162	—	213	218	2	1	4.43
	229.9	35	—	2.1	2.1	164	143	267	287	5.35 10.7	AC302335B	AC302335BDB	—	2	97.2	194.4	—	162	—	217.9	217.9	2	2	4.70
	270	45	—	3	1.1	310	280	504	560	9.95 19.9	7230	7230DB	7230DF	1	83.1	166.3	76.3	164	—	256	263	2.5	1	9.75
	270	45	—	3	1.1	281	254	456	509	9.05 18.1	7230B	7230BDB	7230BDF	1	110.6	221.2	131.2	164	—	256	263	2.5	1	9.75
	320	65	—	4	1.5	434	414	706	829	14.0 27.9	7330	7330DB	7330DF	1	100.3	200.7	70.7	168	—	302	311.5	3	1.5	22.4
320	65	—	4	1.5	397	380	645	760	12.8 25.6	7330B	7330BDB	7330BDF	1	131.1	262.2	132.2	168	—	302	311.5	3	1.5	22.4	
160	215	28	25	2	1.5	107	102	174	204	3.85 7.70	AC3222B	AC3222BDB	—	3	91.2	182.3	—	170	—	205	208	2	1.5	2.60
	220	28	—	2	1	136	129	221	259	4.85 9.70	7932	7932DB	7932DF	1	68.9	137.7	81.7	170	—	210	214.5	2	1	3.00
	220	28	—	2	1	121	113	197	226	4.25 8.45	7932B	7932BDB	7932BDF	1	93.7	187.4	131.4	170	—	210	214.5	2	1	3.00
	229.5	33	—	2	1	138	128	224	256	4.75 9.45	AC322333B	AC322333BDB	AC322333BDF	2	98.3	196.6	130.6	170	165.5	219.5	224	2	1	4.40
	240	38	—	2.1	1.1	194	176	315	353	6.65 13.3	7032	7032DB	7032DF	1	76.8	153.5	77.5	172	—	228	233	2	1	5.45
	240	38	—	2.1	1.1	173	158	282	316	5.80 11.6	7032B	7032BDB	7032BDF	1	102.9	205.8	129.8	172	—	228	233	2	1	5.45
	290	48	—	3	1.1	288	263	468	525	9.05 18.1	7232	7232DB	7232DF	1	89.0	177.9	81.9	174	—	276	283	2.5	1	12.1

[Remark] a_1, a_2 : Load center spread

Single-row, matched pair angular contact ball bearings

d (160) ~ (190) mm

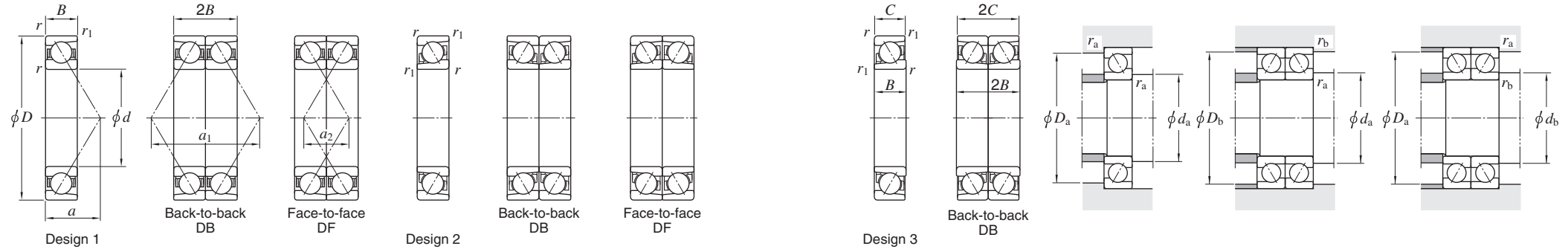

Boundary dimensions (mm)					Basic load ratings (kN)				Fatigue load limit (kN)		Single row	Bearing No.		De-sign	Load center (mm)			Mounting dimensions (mm)				(Refer.) Mass Single row (kg)			
d	D	B	C	$r_{\min.}$	$r_{1\min.}$	Single row C_r	Matched pair C_{0r}	C_r	C_{0r}	(Single row) C_u		(Matched pair) C_u	Back-to-back DB		Face-to-face DF	a	a_1	a_2	d_a min.	d_b min.	D_a max.		D_b max.	r_a max.	r_b max.
160	290	48	—	3	1.1	297	279	482	557	9.60	19.2	7232B	7232BDB	7232BDF	1	118.4	236.8	140.8	174	—	276	283	2.5	1	12.1
	340	68	—	4	1.5	456	455	741	909	14.9	29.7	7332	7332DB	7332DF	1	106.2	212.3	76.3	178	—	322	331.5	3	1.5	26.4
	340	68	—	4	1.5	415	416	675	831	13.6	27.2	7332B	7332BDB	7332BDF	1	138.9	277.8	141.8	178	—	322	331.5	3	1.5	26.4
170	230	28	—	2	1	142	139	230	278	5.10	10.2	7934	7934DB	7934DF	1	71.7	143.5	87.5	180	—	220	224.5	2	1	3.20
	230	28	—	2	1	126	122	205	243	4.45	8.85	7934B	7934BDB	7934BDF	1	97.9	195.8	139.8	180	—	220	224.5	2	1	3.20
	249.5	38	—	2	1	198	186	321	371	6.60	13.2	AC342538	AC342538DB	AC342538DF	1	79.6	159.3	83.3	180	—	239.5	244	2	1	5.80
	249.5	38	—	2	1	177	165	287	329	5.85	11.7	AC342538B	AC342538BDB	AC342538BDF	2	107.1	214.2	138.2	180	175.5	239.5	244	2	1	6.10
	260	42	—	2.1	1.1	232	214	377	429	7.90	15.8	7034	7034DB	7034DF	1	83.1	166.2	82.2	182	—	248	253	2	1	7.58
	260	42	—	2.1	1.1	208	193	338	386	6.90	13.8	7034B	7034BDB	7034BDF	1	111.2	222.4	138.4	182	—	248	253	2	1	7.77
	310	52	—	4	1.5	340	331	552	661	11.0	22.0	7234	7234DB	7234DF	1	95.3	190.6	86.6	188	—	292	301.5	3	1.5	15.1
	310	52	—	4	1.5	306	300	497	600	10.0	20.0	7234B	7234BDB	7234BDF	1	126.7	253.4	149.4	188	—	292	301.5	3	1.5	15.1
	360	72	—	4	1.5	486	485	789	969	15.4	30.7	7334	7334DB	7334DF	1	112.5	225.0	81.0	188	—	342	351.5	3	1.5	31.2
360	72	—	4	1.5	444	444	721	888	14.1	28.2	7334B	7334BDB	7334BDF	1	147.2	294.4	150.4	188	—	342	351.5	3	1.5	31.2	
175	235	30	27	2	1	118	115	191	230	4.15	8.30	AC3524B	AC3524BDB	—	3	101.0	202.0	—	185	—	225	229.5	2	1	6.40
180	250	33	—	2	1	181	177	294	353	6.25	12.5	7936	7936DB	7936DF	1	78.6	157.2	91.2	190	—	240	244.5	2	1	4.80
	250	33	—	2	1	161	154	262	309	5.45	10.9	7936B	7936BDB	7936BDF	1	106.7	213.4	147.4	190	—	240	244.5	2	1	4.70
	259.5	33	—	2	1	180	176	292	353	6.15	12.3	AC3626	AC3626DB	AC3626DF	1	80.0	160.0	94.0	190	—	249.5	254	2	1	5.60
	259.5	33	—	2	1	160	154	261	308	5.35	10.7	AC3626B	AC3626BDB	AC3626BDF	1	108.8	217.6	151.6	190	—	249.5	254	2	1	5.70
	265	33	—	2	2	179	171	291	341	5.90	11.8	AC3627B	AC3627BDB	—	2	110.1	220.1	—	190	—	255	255	2	2	6.3
	280	46	—	2.1	1.1	265	253	430	506	9.15	18.3	7036	7036DB	7036DF	1	89.4	178.8	86.8	192	—	268	273	2	1	10.1
	280	46	—	2.1	1.1	237	228	385	457	7.95	15.9	7036B	7036BDB	7036BDF	1	119.5	239.0	147.0	192	—	268	273	2	1	10.2
	320	52	—	4	1.5	367	362	596	724	11.8	23.7	7236	7236DB	7236DF	1	98.2	196.3	92.3	198	—	302	311.5	3	1.5	15.7
	320	52	—	4	1.5	331	329	538	657	10.7	21.5	7236B	7236BDB	7236BDF	1	130.9	261.8	157.8	198	—	302	311.5	3	1.5	15.7
380	75	—	4	1.5	466	488	757	976	15.1	30.1	7336B	7336BDB	7336BDF	1	155.0	309.9	159.9	198	—	362	371.5	3	1.5	40.0	
190	255	33	29	2	1.1	137	136	222	272	4.70	9.40	AC382633B	AC382633BDB	—	3	109.8	219.7	—	200	—	245	248	2	1	4.30
	259.5	35	—	2	SP	148	147	240	295	5.10	10.2	AC382635AB	AC382635ABDB	AC382635ABDF	2	111.9	223.8	153.8	200	200	249.5	249	2	1	5.00
	260	33	—	2	1	179	176	291	352	6.05	12.1	7938	7938DB	7938DF	1	81.5	162.9	96.9	200	—	250	254.5	2	1	5.00

[Note] 1) SP indicates the specially chamfered form.

[Remark] a_1, a_2 : Load center spread

Single-row, matched pair angular contact ball bearings

d 240 ~ 300 mm

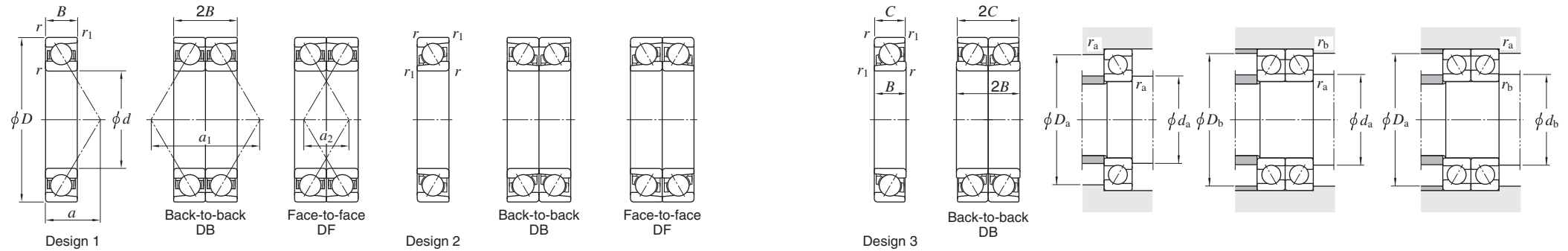

Boundary dimensions (mm)					Basic load ratings (kN)				Fatigue load limit (kN)		Single row	Bearing No.		De-sign	Load center (mm)			Mounting dimensions (mm)				(Refer.) Mass Single row (kg)			
d	D	B	C	r min.	r_1 min.	Single row C_r	Matched pair C_{0r}	C_r	C_{0r}	C_u (Single row)		(Matched pair)	Back-to-back DB		Face-to-face DF	a	a_1	a_2	d_a min.	d_b min.	D_a max.		D_b max.	r_a max.	r_b max.
240	320	38	—	2.1	1.1	241	255	391	510	7.85	15.7	7948	7948DB	7948DF	1	99.8	199.7	123.7	252	—	308	313	2	1	8.00
	320	38	—	2.1	1.1	214	223	348	446	6.90	13.8	7948B	7948BDB	7948BDF	1	136.5	272.9	196.9	252	—	308	313	2	1	8.00
	329.5	40	—	2.1	1.1	247	265	401	529	8.10	16.2	AC4833B	AC4833BDB	AC4833BDF	2	139.6	279.1	199.1	252	247	317.5	322.5	2	1	9.80
	360	56	—	3	1.1	364	375	591	751	12.3	24.6	7048	7048DB	7048DF	1	114.6	229.2	117.2	254	—	346	353	2.5	1	19.7
	360	56	—	3	1.1	325	338	528	677	11.1	22.2	7048B	7048BDB	7048BDF	1	153.9	307.7	195.7	254	—	346	353	2.5	1	20.1
250	340	35	38	2.1	1.5	216	230	351	460	6.90	13.8	AC5034B	AC5034BDB	—	3	141.3	282.5	—	262	—	328	331.5	2	1.5	9.6
	349.5	46	—	2.1	1.1	275	303	446	606	9.05	18.1	AC503546B	AC503546BDB	AC503546BDF	2	148.9	297.7	205.7	262	—	337.5	342.5	2	1	13.2
260	360	46	—	2.1	1.1	314	360	510	720	10.6	21.1	7952	7952DB	7952DF	1	112.5	225.1	133.1	272	—	348	353	2	1	13.8
	360	46	—	2.1	1.1	280	315	455	629	9.25	18.5	7952B	7952BDB	7952BDF	1	153.1	306.1	214.1	272	—	348	353	2	1	13.9
	369.5	46	—	2.1	2.1	308	353	501	706	10.3	20.6	AC523746B	AC523746BDB	AC523746BDF	2	155.2	310.3	218.3	272	272	357.5	357.5	2	2	15.5
	379.5	56	—	3	1.1	330	387	536	774	11.2	22.4	AC5238B	AC5238BDB	AC5238BDF	2	162.3	324.5	212.5	274	267	365.5	372.5	2.5	1	20.6
	400	65	—	4	1.5	407	478	661	956	13.6	27.1	7052	7052DB	7052DF	1	128.4	256.7	126.7	278	—	382	391.5	3	1.5	28.7
400	65	—	4	1.5	364	431	592	862	12.2	24.4	7052B	7052BDB	7052BDF	1	171.0	341.9	211.9	278	—	382	391.5	3	1.5	29.3	
270	379.5	46	—	2.1	1.1	315	367	511	735	10.5	21.1	AC5438B	AC5438BDB	AC5438BDF	2	159.4	318.7	226.7	282	277	367.5	372.5	2	1	24.3
280	380	46	—	2.1	1.1	318	372	516	744	10.6	21.2	7956	7956DB	7956DF	1	118.3	236.6	144.6	292	—	368	373	2	1	14.2
	380	46	—	2.1	1.1	283	325	460	651	9.25	18.5	7956B	7956BDB	7956BDF	1	161.5	322.9	230.9	292	—	368	373	2	1	14.7
	389.5	46	—	2.1	SP	321	381	522	763	10.8	21.5	AC563946AB	AC563946ABDB	AC563946ABDF	2	163.5	327.1	235.1	292	287	377.5	382	2	1	16.5
	400	52	—	4	1.5	335	401	544	803	11.2	22.5	AC5640B	AC5640BDB	AC5640BDF	1	228.6	457.2	353.2	298	—	382	391.5	3	1.5	20.5
	420	65	—	4	1.5	415	507	675	1 010	14.0	27.9	7056	7056DB	7056DF	1	133.5	267.1	137.1	298	—	402	411.5	3	1.5	30.4
420	65	—	4	1.5	384	453	623	906	13.1	26.2	7056B	7056BDB	7056BDF	1	179.3	358.7	228.7	298	—	402	411.5	3	1.5	31.0	
285	380	46	—	3	1.1	257	296	418	592	8.40	16.8	AC5738	AC5738DB	AC5738DF	1	119.0	238.0	146.0	299	—	366	373	2.5	1	14.1
	380	46	—	2	2	255	291	414	582	8.25	16.5	AC5738B	AC5738BDB	AC5738BDF	2	162.7	325.4	233.4	295	—	370	370	2	2	14.2
290	409.5	56	—	3	1.1	357	438	579	875	12.1	24.2	AC584156B	AC584156BDB	AC584156BDF	2	174.8	349.7	237.7	304	297	395.5	402.5	2.5	1	22.5
	419.5	60	—	4	1.5	365	455	593	910	12.5	25.0	AC5842B	AC5842BDB	AC5842BDF	2	178.9	357.9	237.9	308	298.5	401.5	411	3	1.5	26.5
300	419.5	56	—	3	1.1	354	436	576	873	11.9	23.8	AC604245B	AC604256BDB	AC604256BDF	2	179	358.1	246.1	314	307	405.5	412.5	2.5	1	23
	460	74	—	4	1.5	478	613	776	1 230	16.3	32.5	7060B	7060BDB	7060BDF	1	196.4	392.9	244.9	318	—	442	451.5	3	1.5	44.9

[Note] 1) SP indicates the specially chamfered form.

[Remark] a_1, a_2 : Load center spread

Single-row, matched pair angular contact ball bearings

d 310 ~ 670 mm

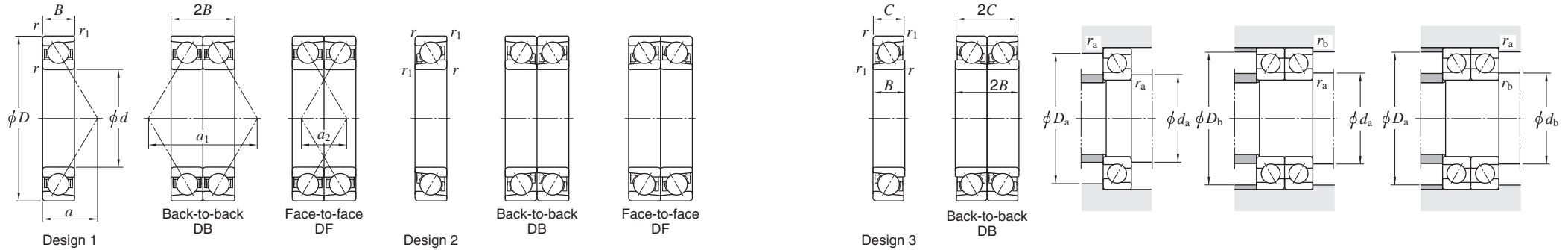

Boundary dimensions (mm)						Basic load ratings (kN)				Fatigue load limit (kN)		Single row	Bearing No.			De-sign	Load center (mm)			Mounting dimensions (mm)						(Refer.) Mass Single row (kg)
d	D	B	C	$r_{\min.}$	$r_{1\min.}$	C_r	C_{0r}	C_r	C_{0r}	C_u	C_u		Back-to-back DB	Face-to-face DF	a		a_1	a_2	d_a min.	d_b min.	D_a max.	D_b max.	r_a max.	r_b max.		
310	429.5	60	—	4	1.5	352	435	572	870	11.7	23.4	AC624360B	AC624360BDB	AC624360BDF	2	185.2	370.5	250.5	328	318.5	411.5	421	3	1.5	24.5	
320	449.5	56	—	3	1.1	398	513	646	1 030	13.5	27.0	AC644556B	AC644556BDB	AC644556BDF	2	189.5	379.1	267.1	334	327	435.5	442.5	2.5	1	27.4	
340	479.5	65	—	3	1.1	442	595	718	1 190	15.2	30.4	AC6848B	AC6848BDB	AC6848BDF	2	204.5	409.0	279.0	354	347	465.5	472.5	2.5	1	35.7	
350	559.5	86	—	4	1.5	659	952	1 070	1 900	23.1	46.1	AC7056B	AC7056BDB	AC7056BDF	2	233.9	467.8	295.8	368	358.5	541.5	551	3	1.5	81.6	
360	509.5	70	—	5	2	475	656	771	1 310	16.2	32.5	AC7251B	AC7251BDB	AC7251BDF	1	217.5	435	295	382	—	487.5	499.5	4	2	42.9	
	539.5	82	—	4	1.5	577	824	937	1 650	20.1	40.1	AC725482B	AC725482BDB	AC725482BDF	2	229.8	459.6	295.6	378	368.5	521.5	531	3	1.5	63.5	
380	480	46	—	2.1	1.1	316	416	513	833	10.4	20.7	7876B	7876BDB	7876BDF	1	203.4	406.8	314.8	392	—	468	473	2	1	18.8	
	519.5	65	—	4	1.5	424	590	689	1 180	14.4	28.7	AC7652AB	AC7652ABDB	AC7652ABDF	2	221.3	442.6	312.6	398	388.5	501.5	511	3	1.5	39.2	
	540	82	—	4	1.1	520	747	845	1 490	18.0	36.0	AC7654B	AC7654BDB	AC7654BDF	1	234.0	468.0	304.0	398	—	522	533	3	1	58.3	
400	559.5	70	—	4	1.5	503	734	817	1 470	17.3	34.6	AC8056B	AC8056BDB	AC8056BDF	2	236.4	472.8	332.8	418	408.5	541.5	551	3	1.5	52.1	
420	559.5	65	—	4	1.5	469	683	762	1 370	15.9	31.9	AC8456B	AC8456BDB	AC8456BDF	2	238.1	476.2	346.2	438	428.5	541.5	551	3	1.5	55.9	
500	620	56	—	3	1.1	475	740	771	1 480	16.2	32.3	78/500	78/500DB	78/500DF	1	189.7	379.4	267.4	514	—	606	613	2.5	1	35.5	
530	780	112	—	6	3	1 010	1 810	1 640	3 620	36.6	73.1	70/530	70/530DB	70/530DF	1	245.1	490.2	266.2	558	—	752	766	5	2.5	174	
560	750	85	—	5	2	676	1 170	1 100	2 330	23.5	47.1	79/560B	79/560BDB	79/560BDF	1	231.6	463.2	293.2	582	—	728	740	4	2	102	
670	900	103	—	6	3	879	1 680	1 430	3 370	31.1	62.1	79/670B	79/670BDB	79/670BDF	1	380.8	761.7	555.7	698	—	872	886	5	2.5	178	

[Remark] a_1, a_2 : Load center spread

d 120 ~ 280 mm

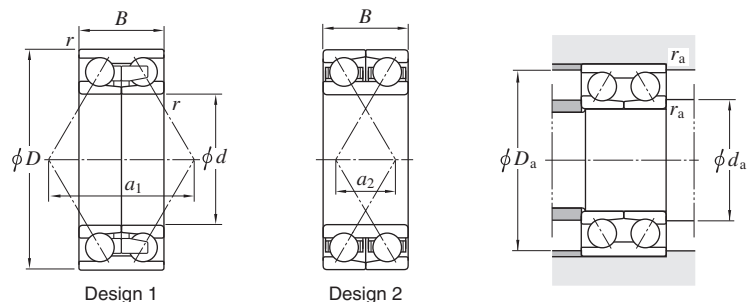

Boundary dimensions (mm)				Basic load ratings (kN)		Fatigue load limit (kN)	Bearing No. ¹⁾	De- sign	Load center spread (mm)	Mounting dimensions (mm)			(Refer.)
d	D	B	$r_{\min.}$	C_r	C_{0r}	C_u	Open		a_1, a_2	d_a min.	D_a max.	r_a max.	Mass (kg)
120	190	66	2	209	213	8.85	2AC2419B	1	163.1	130	180	2	6.90
140	210	66	2	231	249	6.60	305275-1	1	142.4	150	200	2	7.80
150	225	73	2.1	269	293	11.1	305333-1	1	145.0	162	213	2	10.0
	230	70	2.1	269	294	11.0	305283-1	1	144.7	162	218	2	10.0
160	239.5	76	2.1	315	352	12.9	305183/1D	2	77.7	172	227	2	11.1
170	260	84	2.1	338	386	13.6	305180-1	2	138.8	182	248	2	13.0
180	259.5	66	2	265	326	11.3	305262-1	1	160.0	190	249.5	2	11.0
	280	92	2.1	385	457	15.6	305172B-1	2	147.4	192	268	2	17.0
190	269.5	66	2.1	262	324	11.0	305338A-1	1	165.8	202	257.5	2	12.0
	290	92	2.1	427	510	17.0	305178	1	184.6	202	278	2	21.5
200	279.5	76	2.1	321	388	12.9	305424	2	100.6	212	267.5	2	14.0
	279.5	76	2.1	321	388	12.9	305428-1	1	176.6	212	267.5	2	14.0
	289.5	76	2.1	390	479	15.8	305263-1	1	179.5	212	277.5	2	16.5
220	309.5	76	2.1	347	448	14.2	305272-1	1	191.0	230	299.5	2	22.0
	319.5	92	2.1	431	562	17.7	2AC4432B-1	1	230.6	232	307.5	2	24.0
230	329.5	80	2.1	421	559	17.3	305264-1	1	201.7	242	317.5	2	22.0
260	369.5	92	2.1	535	765	22.3	305270-1	1	227.9	272	357.5	2	31.0
280	389.5	92	2.1	508	744	21.0	305269-1	1	239.4	292	377.5	2	33.0

[Note] 1) Bearing No.305275-1 and 305262-1 indicate nominal contact angle of 32°. Bearing No. 2AC2419B, 305180-1, 305172B-1, and 2AC4432B-1 indicate nominal contact angle of 40°, and nominal contact angle of other bearings is 30°.

[Remark] 1) Some of these bearings have lubrication grooves or lubrication holes on their outer rings.

Cylindrical roller bearings



- Cylindrical roller bearings feature high radial load capacity because the rollers and raceway are in linear contact. These bearings are suitable for applications that involve heavy radial and impact loading.
- They are appropriate for high-speed applications in that they can be machined very accurately due to their structure.
- The NU and N types exhibit their best performance when used as free side bearings since they adjust to the shaft's axial movement, to a certain extent, relative to the housing position.
- The NJ and NF types carry axial load in one direction, while the NUP type can carry a certain degree of axial load in both directions.

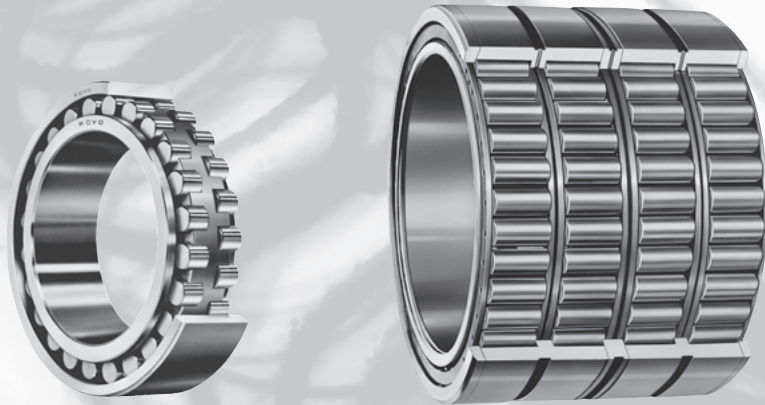

- Double-row cylindrical roller bearings come in two types : with a cylindrical bore, and with a tapered bore. As for those with a tapered bore, the specified amount of clearance can be obtained by adjusting the press-in distance. Some bearings have lubrication holes and lubrication grooves on the outer ring. They are identified by supplementary code "W".

■ Single-row (page 124)

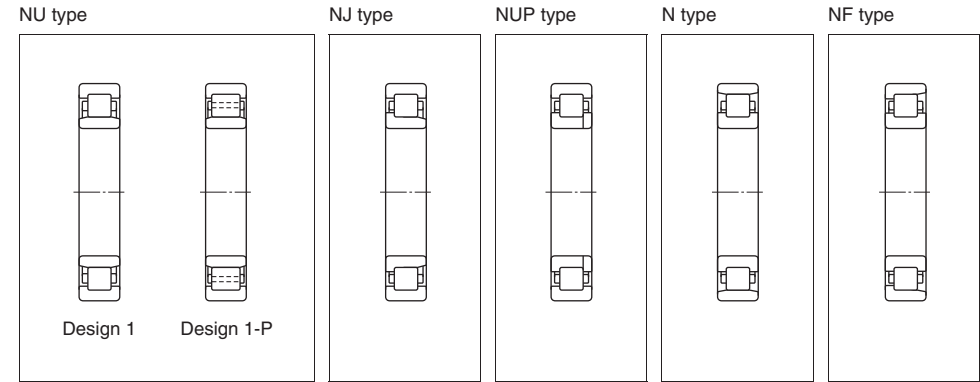

■ Double-row (page 138)

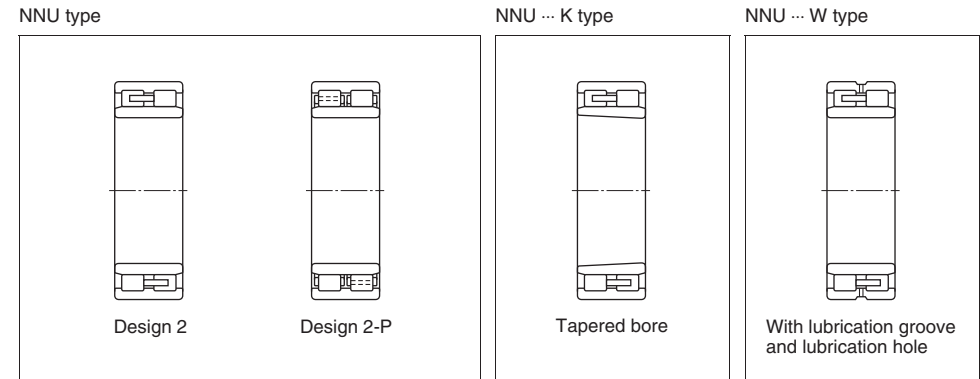
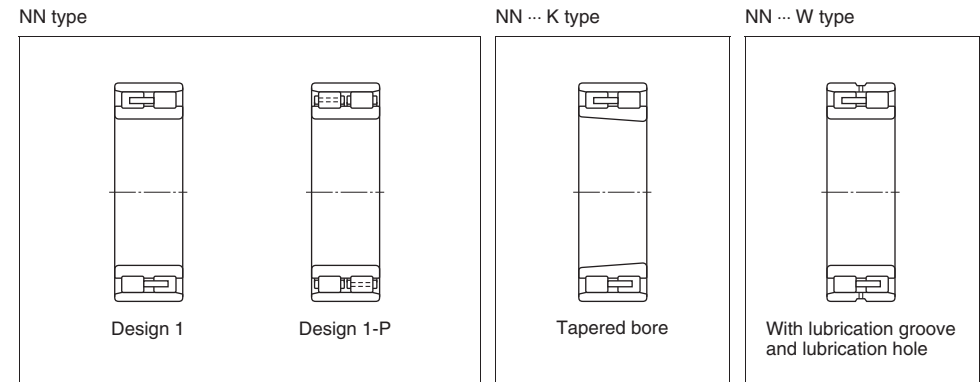

■ Four-row ... Cylindrical bore (page 146)

	Outer ring with rib	Outer ring with loose rib
One inner ring	<p>Design 1-1 Design 1-2 Design 1-3 Design 1-4</p>	<p>Design 1-6P</p>
Two inner rings	<p>Design 2-1P Design 2-2 Design 2-2P Design 2-3 Design 2-4</p>	<p>Design 2-5P Design 2-6P</p>
Oil mist lubrication		<p>Design 3-1 Design 3-1P Design 3-2P</p>

- Four-row cylindrical roller bearings, having superior resistance to radial load, are suitable for use at a high-speed.
- Since the inner ring raceway surface and the roll can be finished simultaneously after the inner ring is mounted on the roll neck (the inner ring raceway surface is grounded by a roll grinding machine, and then, the roll barrel is finished based on the grounded surface), rolling accuracy is improved. Additionally, residual clearance of the bearing can be adjusted freely.
- Some four-row cylindrical roller bearings have nozzle holes and O-rings for oil mist lubrication.

■ Four-row ... Tapered bore (page 172)

<p>Design 1-1 Design 1-2</p>	<p>Design 1-3P Design 1-4 Design 2-2 Design 2-3</p>
---------------------------------	--

Boundary dimensions	The dimensions of standard series are as specified in JIS B 1512.																																																																																																										
Tolerances	<p>As specified in JIS B 1514.</p> <ul style="list-style-type: none"> • Single-row, double-row and four-row cylindrical bore bearings...Classes 0, 6 and 5 • Four-row tapered bore bearings...Classes 0 and 6 (refer to Table 2-2 on page 18) <p style="text-align: center;">Tolerances of roller set bore diameter F_w and roller set outside diameter E_w of interchangeable bearings</p> <p style="text-align: right;">Unit : μm</p> <table border="1" style="width: 100%; border-collapse: collapse;"> <thead> <tr> <th colspan="2" rowspan="2">Nominal bore diameter d (mm)</th> <th colspan="2">Roller set bore diameter deviation ΔF_w</th> <th colspan="2">Roller set outside diameter deviation ΔE_w</th> </tr> <tr> <th>upper</th> <th>lower</th> <th>upper</th> <th>lower</th> </tr> </thead> <tbody> <tr> <td>over</td> <td>up to</td> <td></td> <td></td> <td></td> <td></td> </tr> <tr> <td>50</td> <td>120</td> <td>+ 20</td> <td>0</td> <td>0</td> <td>- 20</td> </tr> <tr> <td>120</td> <td>200</td> <td>+ 25</td> <td>0</td> <td>0</td> <td>- 25</td> </tr> <tr> <td>200</td> <td>250</td> <td>+ 30</td> <td>0</td> <td>0</td> <td>- 30</td> </tr> <tr> <td>250</td> <td>315</td> <td>+ 35</td> <td>0</td> <td>0</td> <td>- 35</td> </tr> <tr> <td>315</td> <td>400</td> <td>+ 40</td> <td>0</td> <td>0</td> <td>- 40</td> </tr> <tr> <td>400</td> <td>500</td> <td>+ 45</td> <td>0</td> <td>0</td> <td>- 45</td> </tr> <tr> <td>500</td> <td>600</td> <td>+ 50</td> <td>0</td> <td>0</td> <td>- 50</td> </tr> <tr> <td>600</td> <td>700</td> <td>+ 55</td> <td>0</td> <td>0</td> <td>- 55</td> </tr> <tr> <td>700</td> <td>800</td> <td>+ 60</td> <td>0</td> <td>0</td> <td>- 60</td> </tr> <tr> <td>800</td> <td>900</td> <td>+ 70</td> <td>0</td> <td>0</td> <td>- 70</td> </tr> <tr> <td>900</td> <td>1 000</td> <td>+ 80</td> <td>0</td> <td>0</td> <td>- 80</td> </tr> <tr> <td>1 000</td> <td>1 250</td> <td>+ 90</td> <td>0</td> <td>0</td> <td>- 90</td> </tr> <tr> <td>1 250</td> <td>1 600</td> <td>+100</td> <td>0</td> <td>0</td> <td>-100</td> </tr> <tr> <td>1 600</td> <td>2 000</td> <td>+120</td> <td>0</td> <td>0</td> <td>-120</td> </tr> <tr> <td>2 000</td> <td>2 500</td> <td>+150</td> <td>0</td> <td>0</td> <td>-150</td> </tr> </tbody> </table> <p>[Remark] Interchangeable bearings have an inner ring with rollers that can be matched with the outer ring, or an outer ring with rollers that can be matched with the inner ring, without affecting performance in the bearing that has the same bearing number in one category.</p>	Nominal bore diameter d (mm)		Roller set bore diameter deviation ΔF_w		Roller set outside diameter deviation ΔE_w		upper	lower	upper	lower	over	up to					50	120	+ 20	0	0	- 20	120	200	+ 25	0	0	- 25	200	250	+ 30	0	0	- 30	250	315	+ 35	0	0	- 35	315	400	+ 40	0	0	- 40	400	500	+ 45	0	0	- 45	500	600	+ 50	0	0	- 50	600	700	+ 55	0	0	- 55	700	800	+ 60	0	0	- 60	800	900	+ 70	0	0	- 70	900	1 000	+ 80	0	0	- 80	1 000	1 250	+ 90	0	0	- 90	1 250	1 600	+100	0	0	-100	1 600	2 000	+120	0	0	-120	2 000	2 500	+150	0	0	-150
Nominal bore diameter d (mm)				Roller set bore diameter deviation ΔF_w		Roller set outside diameter deviation ΔE_w																																																																																																					
		upper	lower	upper	lower																																																																																																						
over	up to																																																																																																										
50	120	+ 20	0	0	- 20																																																																																																						
120	200	+ 25	0	0	- 25																																																																																																						
200	250	+ 30	0	0	- 30																																																																																																						
250	315	+ 35	0	0	- 35																																																																																																						
315	400	+ 40	0	0	- 40																																																																																																						
400	500	+ 45	0	0	- 45																																																																																																						
500	600	+ 50	0	0	- 50																																																																																																						
600	700	+ 55	0	0	- 55																																																																																																						
700	800	+ 60	0	0	- 60																																																																																																						
800	900	+ 70	0	0	- 70																																																																																																						
900	1 000	+ 80	0	0	- 80																																																																																																						
1 000	1 250	+ 90	0	0	- 90																																																																																																						
1 250	1 600	+100	0	0	-100																																																																																																						
1 600	2 000	+120	0	0	-120																																																																																																						
2 000	2 500	+150	0	0	-150																																																																																																						
Allowable misalignment	<p>Allowable misalignment of single-row cylindrical roller bearings depends on bearing type and specification.</p> <p>General values are as follows :</p> <ol style="list-style-type: none"> 1) When P_r / C_r is approx. 10% under load of normal use0.000 6 rad (2') - 0.000 9 rad (3') 2) When P_r / C_r is approx. 6% under load lighter than 1)0.001 2 rad (4') <p>When very large allowable misalignment is required, consult with JTEKT.</p>																																																																																																										
Radial internal clearance	(refer to Table 4-4 on pages 51 and 52)																																																																																																										

Standard cages	Machined cage or pin type cage																						
Equivalent radial load	<p>Dynamic equivalent radial load $P_r = F_r$</p> <p>Static equivalent radial load $P_{0r} = F_r$</p>																						
Allowable axial load	<p>Cylindrical roller bearings with ribs, including loose rib, on both inner and outer rings accommodate axial load to a certain extent.</p> <p>In such cases, axial load capacity is controlled by the condition of roller end faces, forms of rib or loose rib, lubrication, rotational speed etc.</p> <p>For certain special uses, a design is available to accommodate very heavy axial loads. In general, axial loads allowable for cylindrical roller bearings can be calculated using the following equation, which are based on empirical data.</p> $F_{ap} = 9.8 f_a \cdot f_b \cdot f_p \cdot d_m^2$ <p>where :</p> <ul style="list-style-type: none"> F_{ap} : maximum allowable axial load N f_a : coefficient determined from loading condition (see below) f_b : coefficient determined from bearing diameter series (see below) f_p : coefficient for rib surface pressure (see below) <p>d_m : mean value of bore diameter d and outside diameter D ... $\left(\frac{d+D}{2} \right)$ mm</p> <table border="1" style="width: 100%; border-collapse: collapse;"> <thead> <tr> <th>Loading condition</th> <th>f_a</th> <th>Diameter series</th> <th>f_b</th> </tr> </thead> <tbody> <tr> <td rowspan="2">Continuous loading</td> <td rowspan="2">1</td> <td>8</td> <td>0.4</td> </tr> <tr> <td>9</td> <td>0.6</td> </tr> <tr> <td rowspan="2">Intermittent loading</td> <td rowspan="2">2</td> <td>0</td> <td>0.7</td> </tr> <tr> <td>2</td> <td>0.8</td> </tr> <tr> <td rowspan="2">Instantaneous loading</td> <td rowspan="2">3</td> <td>3</td> <td>1.0</td> </tr> <tr> <td>4</td> <td>1.2</td> </tr> </tbody> </table> <p style="text-align: center;">Relationship between coefficient f_p and value $d_m n$ (n : rotational speed, min^{-1})</p>	Loading condition	f_a	Diameter series	f_b	Continuous loading	1	8	0.4	9	0.6	Intermittent loading	2	0	0.7	2	0.8	Instantaneous loading	3	3	1.0	4	1.2
Loading condition	f_a	Diameter series	f_b																				
Continuous loading	1	8	0.4																				
		9	0.6																				
Intermittent loading	2	0	0.7																				
		2	0.8																				
Instantaneous loading	3	3	1.0																				
		4	1.2																				

Single-row cylindrical roller bearings

d 100 ~ (120) mm

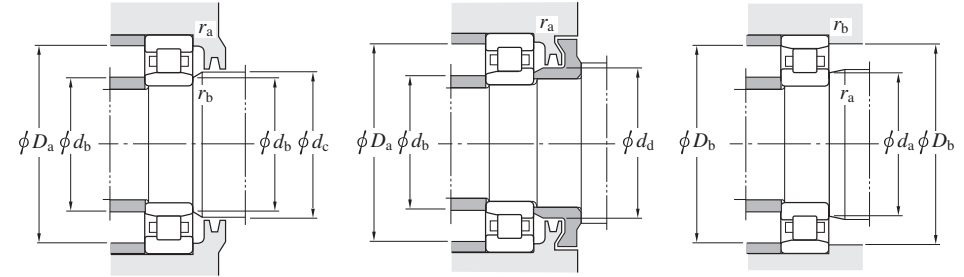
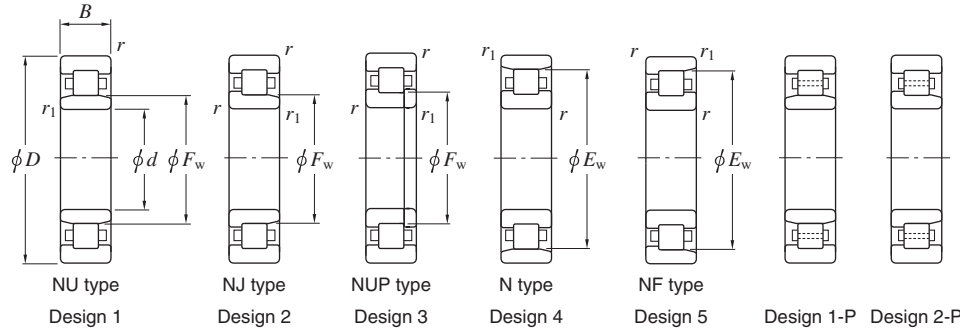

Boundary dimensions (mm)							Basic load ratings (kN)		Fatigue load limit (kN) C_u	Bearing No. ¹⁾	De- sign	Mounting dimensions (mm)								(Refer.) Mass NU (N) (kg)			
d	D	B	r min.	r_1 min.	F_w	E_w	C_r	C_{0r}				d_a min.	d_b min. max.	d_c min.	d_d min.	D_a max.	D_b max. min.	r_a max.	r_b max.				
100	150	24	1.5	1.1	113	—	114	120	15.8	NU1020	1, 3	108	106.5	111	116	—	142	—	—	1.5	1	1.46	
	180	34	2.1	2.1	—	160	229	217	28.1	N220	4, 5	111	—	—	—	130	169	169	164	2	2	(3.38)	
	180	34	2.1	2.1	119	—	312	306	43.0	NU220R	1-3	111	111	117	122	130	169	—	—	2	2	3.52	
	180	46	2.1	2.1	120	—	322	338	47.3	NU2220	1-3	111	111	117	122	130	169	—	—	2	2	4.67	
	180	46	2.1	2.1	119	—	417	444	60.7	NU2220R	1-3	111	111	117	122	130	169	—	—	2	2	4.82	
	180	60.3	2.1	2.1	120	—	409	459	61.9	NU3220	1	111	111	117	122	—	169	—	—	2	2	6.62	
	215	47	3	3	—	185.5	373	337	47.2	N320	4, 5	113	—	—	—	143	202	202	190	2.5	2.5	(7.59)	
	215	47	3	3	—	127.5	—	474	424	58.7	NU320R	1-3	113	113	125	132	143	202	—	—	2.5	2.5	7.75
	215	73	3	3	—	129.5	—	544	548	74.1	NU2320	1-3	113	113	125	132	143	202	—	—	2.5	2.5	11.9
	215	73	3	3	—	127.5	—	713	717	94.7	NU2320R	1-3	113	113	125	132	143	202	—	—	2.5	2.5	12.1
215	82.6	3	3	—	129.5	—	663	706	93.2	NU3320	1	113	113	125	132	—	202	—	—	2.5	2.5	15.0	
105	160	26	2	1.1	119.5	—	136	149	19.6	NU1021	1, 3	114	111.5	118	122	—	151	—	—	2	1	1.85	
	190	36	2.1	2.1	—	168.8	251	241	34.1	N221	4, 5	116	—	—	—	137	179	179	173	2	2	(4.44)	
	225	49	3	3	—	195	451	417	57.2	N321	4, 5	118	—	—	—	149	212	212	199	2.5	2.5	(8.68)	
	225	77	3	3	—	135	—	711	750	97.3	NU2321	1, 3	118	118	131	138	—	212	—	—	2.5	2.5	15.6
110	170	28	2	1.1	125	—	168	171	21.7	NU1022	1, 3	119	116.5	124	128	—	161	—	—	2	1	2.31	
	200	38	2.1	2.1	—	178.5	300	290	40.1	N222	4, 5	121	—	—	—	144	189	189	182	2	2	(5.24)	
	200	38	2.1	2.1	132.5	—	366	365	51.1	NU222R	1-3	121	121	130	135	144	189	—	—	2	2	4.90	
	200	53	2.1	2.1	132.5	—	416	442	58.8	NU2222	1-3	121	121	130	135	144	189	—	—	2	2	6.93	
	200	53	2.1	2.1	132.5	—	479	517	69.9	NU2222R	1-3	121	121	130	135	144	189	—	—	2	2	6.93	
	200	69.8	2.1	2.1	132.5	—	533	607	80.6	NU3222	1	121	121	130	135	—	189	—	—	2	2	9.55	
	240	50	3	3	—	207	502	467	62.9	N322	4, 5	123	—	—	—	158	227	227	211	2.5	2.5	(10.4)	
	240	50	3	3	—	143	—	564	525	70.0	NU322R	1-3	123	123	140	145	158	227	—	—	2.5	2.5	10.7
	240	80	3	3	—	143	—	755	789	102	NU2322	1-3	123	123	140	145	158	227	—	—	2.5	2.5	18.8
	240	80	3	3	—	143	—	843	880	112	NU2322R	1-3	123	123	140	145	158	227	—	—	2.5	2.5	18.8
120	165	27	1.1	1.1	131.5	—	146	188	23.1	NU2924	1	126.5	126.5	130	134	—	158.5	—	—	1	1	1.72	
	180	28	2	1.1	135	—	173	181	22.6	NU1024	1, 3	129	126.5	134	138	—	171	—	—	2	1	2.47	

[Note] 1) For bearings other than NU type bearings (NJ, NUP, N, and NF types), use NJ, NUP, N, and NF for bearing number instead of supplementary code NU. For example, bearing number of a N type bearing having the same dimensions as NU230 is N230.

When "4, 5" is on "Design" column, refer to bearing numbers of N type bearings. When two or more numbers for bearings other than that are on "Design" columns, refer to bearing numbers of NU type bearings.

Single-row cylindrical roller bearings

d (120) ~ (140) mm

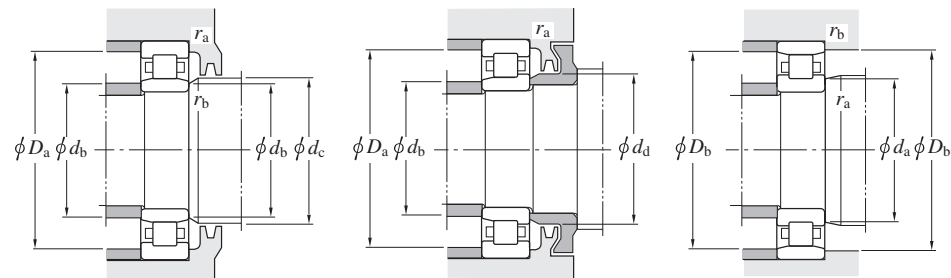
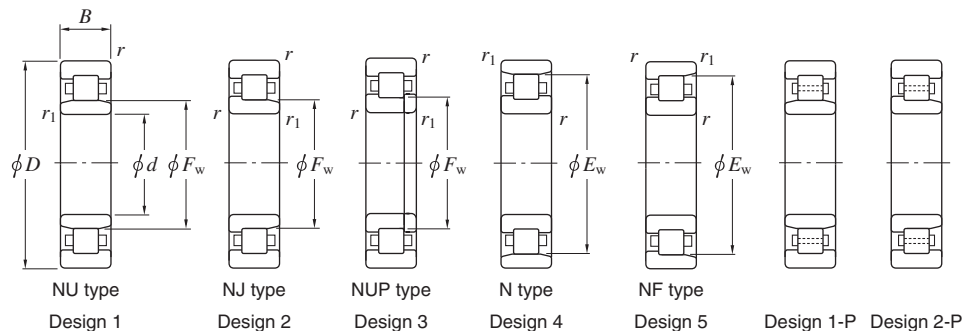

Boundary dimensions (mm)							Basic load ratings (kN)		Fatigue load limit (kN) C_u	Bearing No. ¹⁾	De- sign	Mounting dimensions (mm)								(Refer.) Mass NU (N) (kg)			
d	D	B	r min.	r_1 min.	F_w	E_w	C_r	C_{0r}				d_a min.	d_b min.	d_b max.	d_c min.	d_d min.	D_a max.	D_b max.	D_b min.		r_a max.	r_b max.	
120	215	40	2.1	2.1	—	191.5	325	318	42.9	N224	4, 5	131	—	—	—	156	204	204	196	2	2	(6.31)	
	215	40	2.1	2.1	143.5	—	419	421	57.6	NU224R	1-3	131	131	141	146	156	204	—	—	2	2	5.85	
	215	58	2.1	2.1	143.5	—	456	492	65.3	NU2224	1-3	131	131	141	146	156	204	—	—	2	2	8.56	
	215	58	2.1	2.1	143.5	—	565	619	80.9	NU2224R	1-3	131	131	141	146	156	204	—	—	2	2	8.56	
	215	76	2.1	2.1	143.5	—	596	695	89.2	NU3224	1	131	131	141	146	—	204	—	—	2	2	11.9	
	260	55	3	3	—	226	596	551	72.7	N324	4, 5	133	—	—	—	171	247	247	230	2.5	2.5	(13.1)	
	260	55	3	3	154	—	660	610	79.8	NU324R	1-3	133	133	151	156	171	247	—	—	2.5	2.5	13.4	
	260	86	3	3	154	—	886	918	116	NU2324	1-3	133	133	151	156	171	247	—	—	2.5	2.5	23.1	
	130	180	30	1.5	1.5	142	—	191	243	30.1	NU2926	2	138	138	140	145	150	172	—	—	1.5	1.5	2.27
		200	33	2	1.1	148	—	215	238	29.5	NU1026	1, 3	139	136.5	146	151	—	191	—	—	2	1	3.77
230		40	3	3	—	204	353	362	47.9	N226	4, 5	143	—	—	—	168	217	217	208	2.5	2.5	(7.21)	
230		40	3	3	153.5	—	454	453	61.0	NU226R	1-3	143	143	151	158	168	217	—	—	2.5	2.5	6.60	
230		64	3	3	156	—	495	560	72.8	NU2226	1-3	143	143	151	158	168	217	—	—	2.5	2.5	11.2	
230		64	3	3	153.5	—	662	737	95.8	NU2226R	1-3	143	143	151	158	168	217	—	—	2.5	2.5	11.2	
230		80	3	3	156	—	689	857	107	NU3226	1	143	143	151	158	—	217	—	—	2.5	2.5	14.1	
280		58	4	4	—	243	699	667	85.7	N326	4, 5	146	—	—	—	184	264	264	247	3	3	(16.4)	
280		58	4	4	167	—	771	736	94.1	NU326R	1-3	146	146	164	169	184	264	—	—	3	3	16.7	
280		93	4	4	167	—	1 050	1 130	138	NU2326	1-3	146	146	164	169	184	264	—	—	3	3	29.1	
280		93	4	4	167	—	1 150	1 230	150	NU2326R	1-3	146	146	164	169	186	264	—	—	3	3	29.1	
280		112	4	4	167	—	1 170	1 290	158	NU3326	1	146	146	164	169	—	264	—	—	3	3	34.6	
140		190	30	1.5	1.5	152	—	207	275	32.4	NU2928	2	148	148	151	155	161	182	—	—	1.5	1.5	2.49
	210	33	2	1.1	158	—	220	250	30.5	NU1028	1, 3	149	146.5	156	161	—	201	—	—	2	1	4.00	
	250	42	3	3	—	221	406	421	55.5	N228	4, 5	153	—	—	—	182	237	237	228	2.5	2.5	(8.78)	
	250	42	3	3	169	—	491	514	67.5	NU228R	1-3	153	153	166	171	182	237	—	—	2.5	2.5	8.50	
	250	68	3	3	169	—	583	671	84.3	NU2228	1-3	153	153	166	171	182	237	—	—	2.5	2.5	14.3	
	250	68	3	3	169	—	716	835	106	NU2228R	1-3	153	153	166	171	182	237	—	—	2.5	2.5	14.3	
	300	62	4	4	—	260	771	746	93.8	N328	4, 5	156	—	—	—	198	284	284	264	3	3	(21.8)	
	300	62	4	4	180	—	829	797	99.4	NU328R	1-3	156	156	176	182	198	284	—	—	3	3	21.8	

[Note] 1) For bearings other than NU type bearings (NJ, NUP, N, and NF types), use NJ, NUP, N, and NF for bearing number instead of supplementary code NU. For example, bearing number of a N type bearing having the same dimensions as NU230 is N230.

When "4, 5" is on "Design" column, refer to bearing numbers of N type bearings. When two or more numbers for bearings other than that are on "Design" columns, refer to bearing numbers of NU type bearings.

Single-row cylindrical roller bearings

d (140) ~ (170) mm

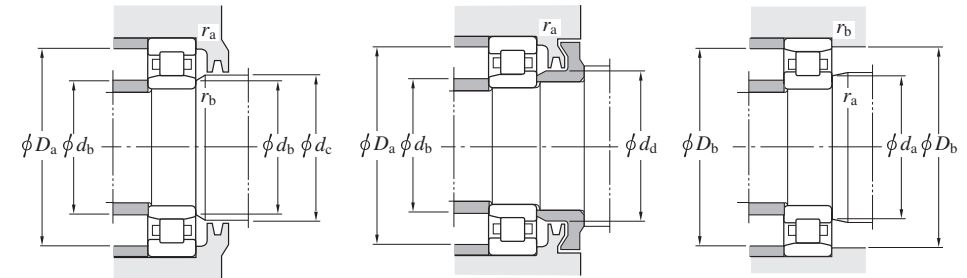
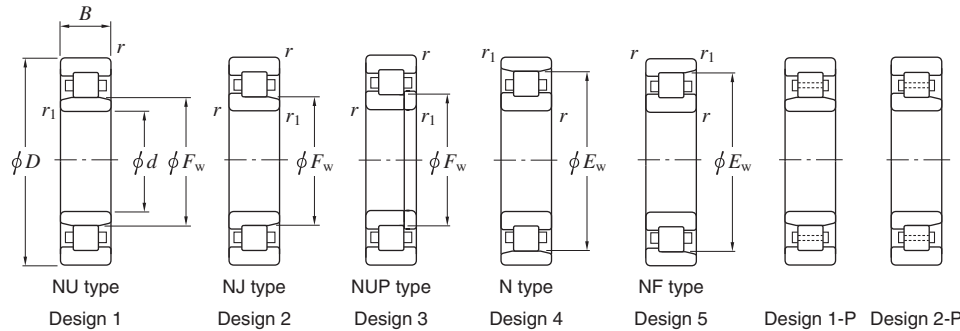

Boundary dimensions (mm)							Basic load ratings (kN)		Fatigue load limit (kN) C_u	Bearing No. ¹⁾	De- sign	Mounting dimensions (mm)								(Refer.) Mass NU (N) (kg)		
d	D	B	r min.	r_1 min.	F_w	E_w	C_r	C_{0r}				d_a min.	d_b min.	d_b max.	d_c min.	d_d min.	D_a max.	D_b max.	D_b min.		r_a max.	r_b max.
140	300	102	4	4	180	—	1 150	1 250	150	NU2328	1-3	156	156	176	182	198	284	—	—	3	3	36.8
	300	102	4	4	180	—	1 270	1 380	167	NU2328R	1-3	156	156	176	182	200	284	—	—	3	3	36.8
150	225	35	2.1	1.5	169.5	—	252	281	32.8	NU1030	1, 3	161	158	167	173	—	214	—	—	2	1.5	4.83
	270	45	3	3	—	238	468	492	63.4	N230	4, 5	163	—	—	—	196	257	257	245	2.5	2.5	(11.1)
	270	45	3	3	182	—	560	594	75.8	NU230R	1-3	163	163	179	184	196	257	—	—	2.5	2.5	10.7
	270	73	3	3	182	—	683	800	99.7	NU2230	1-3	163	163	179	184	196	257	—	—	2.5	2.5	18.7
	270	73	3	3	182	—	828	982	120	NU2230R	1-3	163	163	179	184	196	257	—	—	2.5	2.5	18.7
	320	65	4	4	—	277	829	807	99.1	N330	4, 5	166	—	—	—	213	304	304	281	3	3	(25.6)
	320	65	4	4	193	—	948	922	115	NU330R	1-3	166	166	190	195	213	304	—	—	3	3	27.0
	320	108	4	4	193	—	1 270	1 400	167	NU2330	1-3	166	166	190	195	213	304	—	—	3	3	44.7
	320	108	4	4	193	—	1 450	1 600	187	NU2330R	1-3	166	166	190	195	213	304	—	—	3	3	44.7
	320	128	4	4	193	—	1 610	1 890	217	NU3330	1	166	166	190	195	—	304	—	—	3	3	51.4
160	220	28	2	2	175	—	187	228	25.9	NU1932	2, 3	169	169	173	178	184	211	—	—	2	2	3.08
	220	36	2	2	175	—	249	330	42.5	NU2932	2	169	169	173	178	184	211	—	—	2	2	4.05
	240	38	2.1	1.5	180	—	297	330	42.8	NU1032	1, 3	171	168	178	184	—	229	—	—	2	1.5	5.93
	270	86	2.1	2.1	187	—	854	1 070	129	NU3132	3	171	171	183	190	—	259	—	—	2	2	20.6
	290	48	3	3	—	255	535	568	71.3	N232	4, 5	173	—	—	—	210	277	277	262	2.5	2.5	(13.9)
	290	48	3	3	195	—	624	666	83.3	NU232R	1-3	173	173	192	197	210	277	—	—	2.5	2.5	14.8
	290	80	3	3	195	—	790	939	113	NU2232	1-3	173	173	192	197	210	277	—	—	2.5	2.5	23.6
	290	80	3	3	193	—	1 010	1 190	141	NU2232R	1-3	173	173	192	197	210	277	—	—	2.5	2.5	23.6
	340	68	4	4	—	292	872	876	106	N332	4, 5	176	—	—	—	228	324	324	296	3	3	(30.2)
	340	68	4	4	204	—	1 070	1 050	128	NU332R	1-3	176	176	200	211	228	324	—	—	3	3	32.0
	340	114	4	4	208	—	1 340	1 520	178	NU2332	1-3	176	176	200	211	228	324	—	—	3	3	53.1
	340	114	4	4	204	—	1 640	1 820	212	NU2332R	1-3	176	176	200	211	228	324	—	—	3	3	53.1
170	260	42	2.1	2.1	193	—	347	400	50.5	NU1034	1, 3	181	181	190	197	—	249	—	—	2	2	7.90
	260	67	2.1	2.1	196	—	578	824	98.9	NU3034	1	181	181	193	199	—	249	—	—	2	2	13.0

[Note] 1) For bearings other than NU type bearings (NJ, NUP, N, and NF types), use NJ, NUP, N, and NF for bearing number instead of supplementary code NU. For example, bearing number of a N type bearing having the same dimensions as NU230 is N230.

When "4, 5" is on "Design" column, refer to bearing numbers of N type bearings. When two or more numbers for bearings other than that are on "Design" columns, refer to bearing numbers of NU type bearings.

Single-row cylindrical roller bearings

d (170) ~ (200) mm

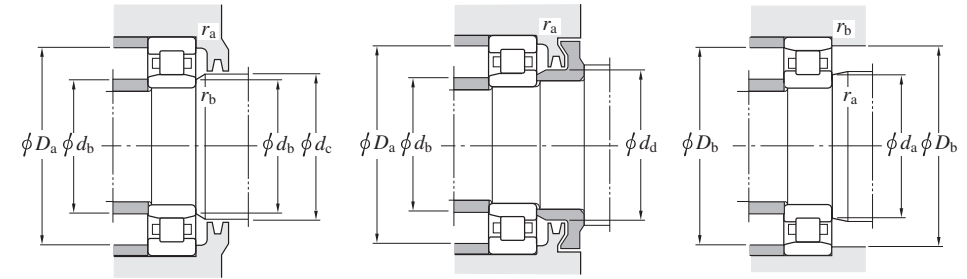
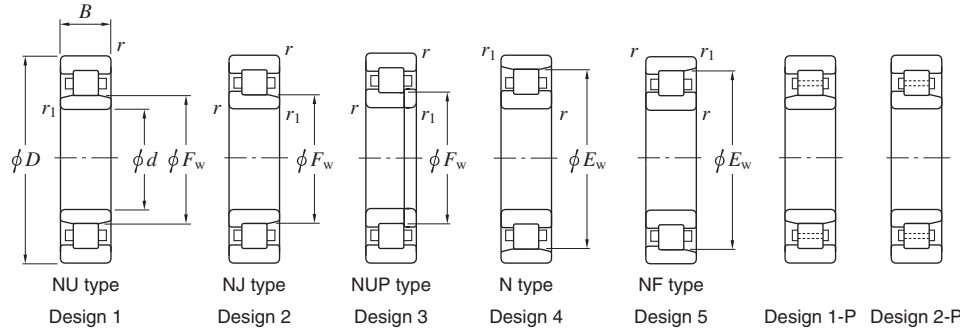

Boundary dimensions (mm)							Basic load ratings (kN)			Fatigue load limit (kN) C_u	Bearing No. ¹⁾	De- sign	Mounting dimensions (mm)								(Refer.) Mass NU (N) (kg)	
d	D	B	r min.	r_1 min.	F_w	E_w	C_r	C_{0r}	d_a min.				d_b min.	d_b max.	d_c min.	d_d min.	D_a max.	D_b max.	D_b min.	r_a max.		r_b max.
170	310	52	4	4	—	272	596	637	78.4	N234	4, 5	186	—	—	—	223	294	294	280	3	3	(17.2)
	310	86	4	4	208	—	896	1 080	127	NU2234	1-3	186	186	204	211	223	294	—	—	3	3	29.2
	310	86	4	4	205	—	1 210	1 410	166	NU2234R	1-3	186	186	204	211	223	294	—	—	3	3	29.2
	360	72	4	4	220	310	997	1 010	122	NU334	1-5	186	186	216	223	241	344	344	314	3	3	38.6
	360	120	4	4	220	—	1 530	1 750	199	NU2334	1-3	186	186	216	223	241	344	—	—	3	3	62.6
180	280	46	2.1	2.1	205	—	447	503	63.2	NU1036	1, 3	191	191	203	209	—	269	—	—	2	2	10.5
	320	52	4	4	—	282	618	677	82.2	N236	4, 5	196	—	—	—	233	304	304	290	3	3	(18.0)
	320	52	4	4	217	—	783	852	104	NU236R	1-3	196	196	214	221	233	304	—	—	3	3	19.3
	320	86	4	4	218	—	929	1 140	133	NU2236	1-3	196	196	214	221	233	304	—	—	3	3	30.4
	320	86	4	4	215	—	1 260	1 510	175	NU2236R	1-3	196	196	214	221	233	304	—	—	3	3	30.4
	320	112	4	4	218	—	1 250	1 680	190	NU3236	1	196	196	214	221	—	304	—	—	3	3	38.4
	380	75	4	4	232	328	1 130	1 150	136	NU336	1-5	196	196	227	235	255	364	364	332	3	3	42.6
	380	126	4	4	232	—	1 690	1 940	220	NU2336	1-3	196	196	227	235	255	364	—	—	3	3	73.0
	380	150	4	4	232	—	2 070	2 520	276	NU3336	1	196	196	227	235	—	364	—	—	3	3	84.4
190	290	46	2.1	2.1	215	—	460	530	65.7	NU1038	1, 3	201	201	213	219	—	279	—	—	2	2	10.9
	340	55	4	4	—	299	694	768	91.3	N238	4, 5	206	—	—	—	247	324	324	310	3	3	(21.5)
	340	55	4	4	230	—	869	954	114	NU238R	1-3	206	206	227	234	247	324	—	—	3	3	23.3
	340	92	4	4	231	—	1 040	1 290	146	NU2238	1-3	206	206	227	234	247	324	—	—	3	3	37.0
	340	120	4	4	231	—	694	1 930	91.3	NU3238	1	206	206	227	234	—	324	—	—	3	3	46.8
	400	78	5	5	245	345	1 220	1 260	146	NU338	1-5	210	210	240	248	268	380	380	349	4	4	49.9
	400	132	5	5	245	—	1 900	2 220	245	NU2338	1-3	210	210	240	248	268	380	—	—	4	4	84.7
	400	155	5	5	245	—	2 340	2 910	316	NU3338	1	210	210	240	248	—	380	—	—	4	4	96.5
200	310	51	2.1	2.1	229	—	487	582	71.0	NU1040	1, 3	211	211	226	233	—	299	—	—	2	2	14.1
	360	58	4	4	—	316	775	865	102	N240	4, 5	216	—	—	—	261	344	344	328	3	3	(25.7)
	360	58	4	4	243	—	958	1 060	124	NU240R	1-3	216	216	240	247	261	344	—	—	3	3	27.2
	360	98	4	4	244	—	1 190	1 490	169	NU2240	1-3	216	216	240	247	261	344	—	—	3	3	44.4
	360	98	4	4	241	—	1 530	1 870	211	NU2240R	1-3	216	216	240	247	261	344	—	—	3	3	44.4

[Note] 1) For bearings other than NU type bearings (NJ, NUP, N, and NF types), use NJ, NUP, N, and NF for bearing number instead of supplementary code NU. For example, bearing number of a N type bearing having the same dimensions as NU230 is N230.

When "4, 5" is on "Design" column, refer to bearing numbers of N type bearings. When two or more numbers for bearings other than that are on "Design" columns, refer to bearing numbers of NU type bearings.

Single-row cylindrical roller bearings

d (200) ~ (280) mm

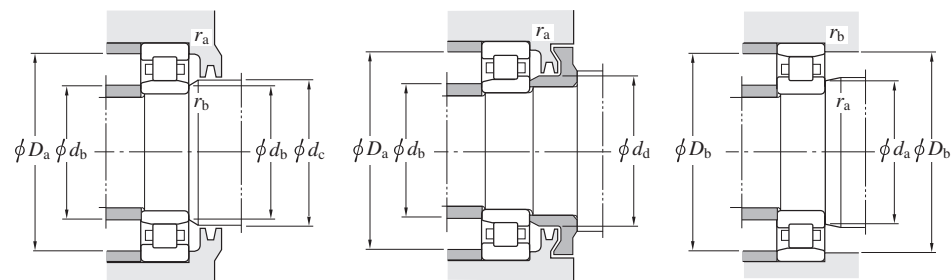
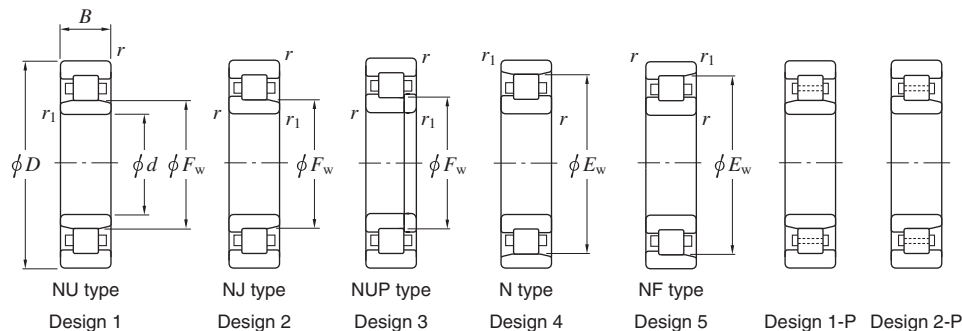

Boundary dimensions (mm)							Basic load ratings (kN)			Fatigue load limit (kN) C_u	Bearing No. ¹⁾	De- sign	Mounting dimensions (mm)									(Refer.) Mass NU (N) (kg)
d	D	B	r min.	r_1 min.	F_w	E_w	C_r	C_{0r}	d_a min.				d_b min.	d_b max.	d_c min.	d_d min.	D_a max.	D_b max.	D_b min.	r_a max.	r_b max.	
200	420	80	5	5	260	360	1 220	1 270	145	NU340	1-5	220	220	254	263	283	400	400	364	4	4	56.2
	420	138	5	5	260	—	1 890	2 240	244	NU2340	1-3	220	220	254	263	283	400	—	—	4	4	97.4
	420	165	5	5	260	—	2 330	2 930	314	NU3340	1	220	220	250	258	—	400	—	—	4	4	113
220	340	56	3	3	250	—	637	748	88.1	NU1044	1, 3	233	233	248	254	—	327	—	—	2.5	2.5	18.5
	370	120	4	4	261	—	1 550	2 140	233	NU3144	1	236	236	255	264	—	354	354	—	3	3	53.2
	400	65	4	4	270	350	949	1 080	123	NU244	1-5	236	236	266	273	289	384	384	362	3	3	38.5
	400	108	4	4	270	—	1 420	1 810	196	NU2244	1, 2	236	236	266	273	289	384	—	—	3	3	60.9
	400	144	4	4	270	—	949	2 880	123	NU3244	1	236	236	266	273	—	384	—	—	3	3	78.8
	460	88	5	5	284	396	1 490	1 570	176	NU344	1-5	240	240	279	287	309	440	440	400	4	4	74.4
	460	145	5	5	284	—	2 260	2 690	287	NU2344	1, 3	240	240	276	287	—	440	—	—	4	4	119
	460	180	5	5	284	—	2 660	3 300	347	NU3344	1	240	240	279	287	—	440	—	—	4	4	148
240	360	56	3	3	270	—	673	822	95.0	NU1048	1, 3	253	253	268	275	—	347	—	—	2.5	2.5	20.1
	360	92	3	3	276	—	970	1 450	156	NU3048	1	253	253	270	279	—	347	347	—	2.5	2.5	33.0
	440	72	4	4	295	385	1 170	1 340	150	NU248	1-5	256	256	293	298	316	424	424	397	3	3	52.1
	440	120	4	4	295	—	1 790	2 320	246	NU2248	1, 2	256	256	293	298	316	424	—	—	3	3	82.5
	440	160	4	4	295	—	2 450	3 460	358	NU3248	1	256	256	293	298	—	424	—	—	3	3	107
	500	95	5	5	310	430	1 790	1 950	211	NU348	1-5	260	260	305	313	337	480	480	434	4	4	94.6
	500	155	5	5	310	—	2 710	3 320	346	NU2348	1, 3	260	260	303	313	—	480	—	—	4	4	152
	260	360	46	2.1	2.1	285	—	566	777	88.8	NU1952	1	271	271	282	288	—	349	349	339	2	2
360		60	2.1	2.1	285	—	700	1 020	114	NU2952	1	271	271	282	288	—	349	349	339	2	2	18.4
400		65	4	4	296	—	819	979	110	NU1052	1, 3	276	276	292	300	—	384	—	—	3	3	29.2
480		80	5	5	320	420	1 380	1 580	171	NU252	1-5	280	280	318	323	343	460	460	432	4	4	69.0
480		130	5	5	320	—	2 240	2 950	305	NU2252	1, 2	280	280	318	323	343	460	—	—	4	4	107
480		174	5	5	320	—	2 680	3 680	373	NU3252	1	280	280	318	323	—	460	—	—	4	4	139
280		350	52	2	2	298	—	536	968	104	NU3856	1	289	289	295	301	—	341	341	—	2	2
	380	46	2.1	2.1	305	—	508	689	78.2	NU1956	1	291	291	302	308	—	369	369	339	2	2	14.7
	420	65	4	4	316	—	841	1 030	114	NU1056	1, 3	296	296	313	320	—	404	—	—	3	3	35.2

[Note] 1) For bearings other than NU type bearings (NJ, NUP, N, and NF types), use NJ, NUP, N, and NF for bearing number instead of supplementary code NU. For example, bearing number of a N type bearing having the same dimensions as NU230 is N230.
When two or more numbers for bearings other than that are on "Design" columns, refer to bearing numbers of NU type bearings.

Single-row cylindrical roller bearings

d (280) ~ 480 mm

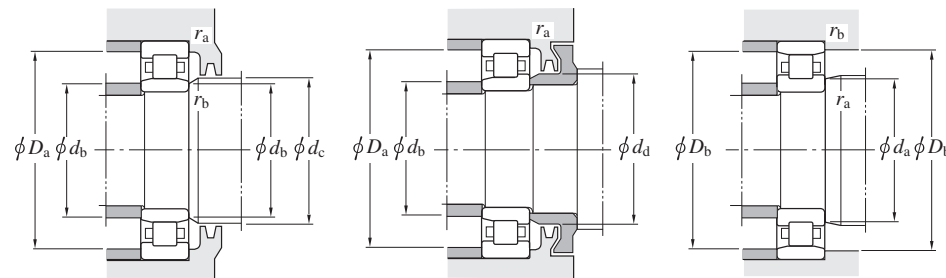
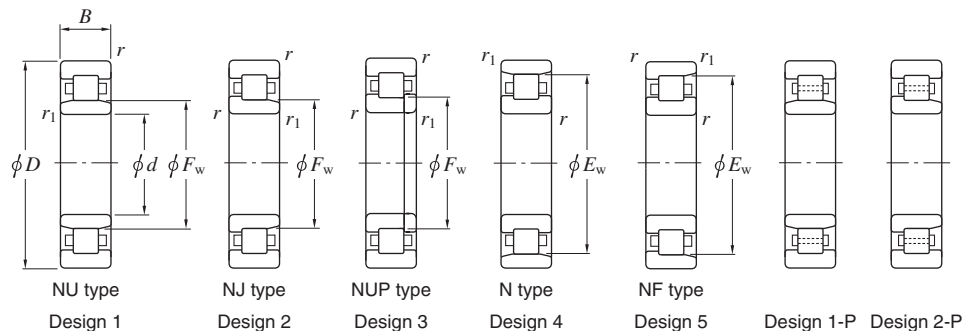

Boundary dimensions (mm)							Basic load ratings (kN)		Fatigue load limit (kN)	Bearing No. ¹⁾	De-sign	Mounting dimensions (mm)								(Refer.) Mass NU (N) (kg)			
d	D	B	r min.	r_1 min.	F_w	E_w	C_r	C_{0r}	C_u			d_a min.	d_b min.	d_b max.	d_c min.	d_d min.	D_a max.	D_b max.	D_b min.		r_a max.	r_b max.	
280	500	80	5	5	340	440	1 430	1 680	179	NU256	1-5		300	300	336	343	365	480	480	452	4	4	72.7
300	380	60	2.1	2.1	322	—	682	1 300	134	NU3860	1		311	311	319	325	—	369	369	—	2	2	16.6
	420	56	3	3	332	—	635	873	96.0	NU1960	1, 2		313	313	328	335	—	407	407	—	2.5	2.5	23.3
	460	74	4	4	340	—	1 120	1 380	147	NU1060	1, 3		316	316	337	344	—	444	—	—	3	3	44.1
	540	85	5	5	364	476	1 690	1 960	206	NU260	1-5		320	320	361	368	392	520	520	487	4	4	90.7
320	480	74	4	4	360	—	1 150	1 450	152	NU1064	1, 3		336	336	356	365	—	464	—	—	3	3	48.4
	580	92	5	5	390	510	1 920	2 270	232	NU264	1-5		340	340	386	393	419	560	560	522	4	4	114
	670	112	7.5	7.5	425	—	2 460	2 880	287	NU364	1		352	352	419	428	—	638	638	575	6	6	199
340	420	60	2.1	2.1	362	—	784	1 500	150	NU3868	1		351	351	359	365	—	409	409	—	2	2	18.1
	460	56	3	3	370	—	756	1 080	114	NU1968	1		353	353	366	373	—	447	447	434	2.5	2.5	25.7
	460	72	3	3	372	—	999	1 620	168	NU2968	1, 3		353	353	368	375	—	447	447	432	2.5	2.5	34.7
	520	82	5	5	385	—	1 370	1 750	183	NU1068	1-3		360	360	381	390	—	500	—	—	4	4	64.1
360	440	38	2.1	2.1	380	—	426	692	66.3	NU1872	1		371	371	378	383	—	429	429	424	2	2	11.7
	480	56	3	3	392	—	708	1 060	111	NU1972	1		373	373	388	395	—	467	467	—	2.5	2.5	27.3
	480	72	3	3	393	—	1 060	1 820	182	NU2972	1		373	373	390	396	—	467	467	451	2.5	2.5	37.2
	540	82	5	5	405	—	1 410	1 830	189	NU1072	1, 3		380	380	401	410	—	520	—	—	4	4	67.1
	540	134	5	5	413	—	2 470	4 180	396	NU3072	1		380	380	407	416	—	520	520	—	4	4	111
380	480	75	2.1	2.1	405	—	1 070	1 970	193	NU3876	1		391	391	401	408	—	469	469	—	2	2	32.3
	560	82	5	5	425	—	1 440	1 920	195	NU1076	1, 3		400	400	421	430	—	540	—	—	4	4	70.1
400	600	90	5	5	450	—	1 760	2 310	229	NU1080	1, 3		420	420	446	455	—	580	—	—	4	4	91.0
	600	148	5	5	450	—	2 830	4 370	407	NU3080	1		420	420	443	453	—	580	580	—	4	4	148
420	620	90	5	5	470	—	1 750	2 320	228	NU1084	1, 3		440	440	466	475	—	600	—	—	4	4	94.6
460	620	74	4	4	500	—	1 320	1 990	193	NU1992	1		476	476	495	503	—	604	604	585	3	3	60.8
480	650	78	5	5	525	—	1 410	2 200	211	NU1996	1		500	500	520	529	—	630	630	—	4	4	72.7

[Note] 1) For bearings other than NU type bearings (NJ, NUP, N, and NF types), use NJ, NUP, N, and NF for bearing number instead of supplementary code NU. For example, bearing number of a N type bearing having the same dimensions as NU230 is N230.

When two or more numbers for bearings other than that are on "Design" columns, refer to bearing numbers of NU type bearings.

Single-row cylindrical roller bearings

d 500 ~ 850 mm

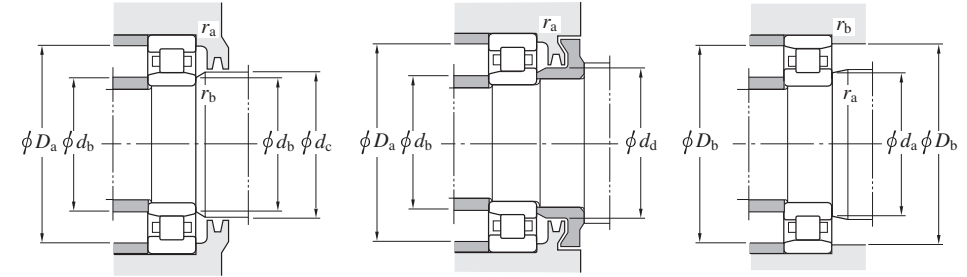
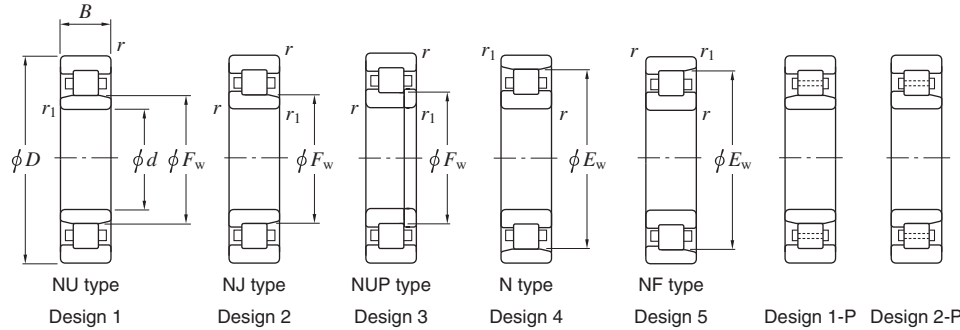

Boundary dimensions (mm)							Basic load ratings (kN)			Fatigue load limit (kN) C_u	Bearing No. ¹⁾	De- sign	Mounting dimensions (mm)								(Refer.) Mass NU (N) (kg)	
d	D	B	r min.	r_1 min.	F_w	E_w	C_r	C_{0r}	d_a min.				d_b min.	d_b max.	d_c min.	d_d min.	D_a max.	D_b max.	r_a min.	r_b max.		
500	620	56	3	3	534	—	884	1 560	147	NU18/500	1	513	513	531	537	—	607	607	594	2.5	2.5	37.3
	620	90	3	3	534	—	1 520	3 140	281	NU38/500	1	513	513	530	537	—	607	607	—	2.5	2.5	61.8
	670	78	5	5	546	—	1 840	3 160	294	NU19/500	1-P	520	520	542	550	—	650	650	—	4	4	78.5
	670	100	5	5	546	—	2 430	4 500	408	NU29/500	1-P	520	520	542	550	—	650	650	—	4	4	101
	720	100	6	6	556	—	2 850	4 440	412	NU10/500	1-P	524	524	551	560	—	696	—	674	5	5	141
530	710	82	5	5	575	—	1 650	2 560	241	NU19/530	2	550	550	570	579	—	690	690	673	4	4	86.9
	710	106	5	5	577	—	2 710	4 850	438	NU29/530	1-P	550	550	572	561	—	690	690	—	4	4	118
560	750	85	5	5	613	—	1 990	3 260	293	NU19/560	1	580	580	609	617	—	730	730	—	4	4	105
	750	112	5	5	613	—	3 130	5 870	514	NU29/560	2-P	580	580	607	617	—	730	730	—	4	4	140
600	800	90	5	5	652	—	2 470	4 170	369	NU19/600	1-P	620	620	647	656	—	780	780	—	4	4	126
630	780	88	4	4	671	—	1 900	3 690	317	NU28/630	1	646	646	665	675	—	764	764	—	3	3	91.8
	850	100	6	6	689	—	3 070	5 240	457	NU19/630	1-P	654	654	684	693	—	826	826	—	5	5	165
670	820	69	4	4	708	—	1 920	3 750	329	NU18/670	1-P, 2-P	686	686	705	712	—	804	804	—	3	3	76.6
850	1 030	106	5	5	900	—	2 660	5 960	468	NU28/850	1	870	870	894	905	—	1 010	1 010	—	4	4	175
	1 120	118	6	6	917	—	4 540	8 190	659	NU19/850	1-P	874	874	911	921	—	1 096	1 096	1 061	5	5	310

[Note] 1) For bearings other than NU type bearings (NJ, NUP, N, and NF types), use NJ, NUP, N, and NF for bearing number instead of supplementary code NU. For example, bearing number of a N type bearing having the same dimensions as NU230 is N230.
When two or more numbers for bearings other than that are on "Design" columns, refer to bearing numbers of NU type bearings.

Double-row cylindrical roller bearings

d 100 ~ 200 mm



Boundary dimensions (mm)						Basic load ratings (kN)		Fatigue load limit (kN) C_u	Bearing No.		De- sign	Mounting dimensions (mm)						(Refer.) Mass (kg) Cylindrical bore
d	D	B	$r_{min.}$	F_w	E_w	C_r	C_{0r}		NN Cylindrical bore	NNU Cylindrical bore		d_a min.	d_a max.	d_b min.	d_b max.	D_a min.	D_a max.	
100	140	40	1.1	113	—	139	258	32.9	—	NNU4920	2	106.5	111	115	133.5	—	1	1.95
	150	37	1.5	—	137	157	265	33.3	NN3020	—	1	108	—	—	142	139	1.5	2.28
105	160	41	2	—	146	197	322	42.5	NN3021	—	1	114	—	—	151	148	2	2.88
110	150	40	1.1	123	—	163	326	42.4	—	NNU4922	2	116.5	121	125	143.5	—	1	2.10
	170	45	2	—	155	221	361	47.9	NN3022	—	1	119	—	—	161	157	2	3.65
120	165	45	1.1	134.5	—	187	373	47.6	—	NNU4924	2	126.5	132	137	158.5	—	1	2.90
	180	46	2	—	165	232	392	51.1	NN3024	—	1	129	—	—	171	167	2	4.00
130	180	50	1.5	146	—	216	428	50.2	—	NNU4926	2	138	143.5	148	172	—	1.5	3.90
	200	52	2	—	182	283	476	57.7	NN3026	—	1	139	—	—	191	183	2	5.94
140	190	50	1.5	156	—	222	456	52.5	—	NNU4928	2	148	153.5	158	182	—	1.5	4.15
	210	53	2	—	192	297	516	61.5	NN3028	—	1	149	—	—	201	194	2	6.41
150	210	60	2	168.5	—	343	692	80.7	—	NNU4930	2	159	166	171	201	—	2	6.50
	225	56	2.1	—	206	334	587	70.1	NN3030	—	1	161	—	—	214	208	2	7.74
160	220	60	2	178.5	—	340	695	79.8	—	NNU4932	2	169	176	182	211	—	2	6.95
	240	60	2.1	—	219	398	695	79.6	NN3032	—	1	171	—	—	229	221	2	9.38
170	230	60	2	188.5	—	361	763	86.4	—	NNU4934	2	179	186	192	221	—	2	7.20
	260	67	2.1	—	236	471	824	105	NN3034	—	1	181	—	—	249	238	2	12.8
180	280	74	2.1	—	255	561	958	118	NN3036	—	1	191	—	—	269	257	2	16.8
190	260	69	2	210	—	465	996	119	—	NNU4938	2	199	207	215	251	—	2	11.0
	290	75	2.1	—	265	598	1 020	128	NN3038	—	1	201	—	—	279	267	2	17.6
200	280	80	2.1	223	—	509	1 050	125	—	NNU4940	2	211	219.5	228	269	—	2	15.4
	310	82	2.1	—	282	631	1 120	137	NN3040	—	1	211	—	—	299	285	2	22.5
	340	112	3	—	304	960	1 640	194	NN3140	—	1	213	—	—	327	307	2.5	41.3

[Remark] The bearing number of the tapered bore type bearing is suffixed by K.

Double-row cylindrical roller bearings

d 220 ~ 410 mm



d	Boundary dimensions (mm)					Basic load ratings (kN)		Fatigue load limit (kN) C_u	Bearing No.		De-sign	Mounting dimensions (mm)						(Refer.) Mass (kg) Cylindrical bore
	D	B	$r_{min.}$	F_w	E_w	C_r	C_{0r}		NN Cylindrical bore	NNU Cylindrical bore		d_a min.	d_a max.	d_b min.	d_b max.	D_a min.	D_a max.	
220	300	80	2.1	244	—	561	1 220	145	—	NNU4944	2	231	241	248	289	—	2	16.7
	370	120	4	263	—	1 110	1 950	223	—	NNU3144	2	236	260	268	354	—	3	52.5
240	320	80	2.1	263	—	588	1 340	155	—	NNU4948	2	251	260	269	309	—	2	18.0
	360	92	3	—	330	864	1 590	184	NN3048	—	1	253	—	—	347	333	2.5	32.8
	400	128	4	286	—	1 270	2 290	257	—	NNU3148	2	256	282	291	384	—	3	65.3
260	360	100	2.1	287	—	941	2 050	228	—	NNU4952	2	271	284	296	349	—	2	31.4
280	380	100	2.1	308	—	976	2 200	239	—	NNU4956	2	291	305	316	369	—	2	33.1
	420	106	4	—	384	1 090	2 010	220	NN3056	—	1	296	—	—	404	387	3	51.2
300	420	118	3	339	—	1 170	2 720	285	—	NNU4960	2	313	335	343	407	—	2.5	51.9
	460	118	4	—	418	1 290	2 460	266	NN3060	—	1	316	—	—	444	421	3	70.8
320	480	121	4	—	438	1 350	2 670	283	NN3064	—	1	336	—	—	464	442	3	76.4
	480	160	4	362	—	1 970	4 040	414	—	NNU4064	2	336	358	367	464	—	3	99.9
340	460	118	3	372	—	1 270	2 930	301	—	NNU4968	2	353	368	383	447	—	2.5	56.8
	520	180	5	387	—	2 370	4 810	486	—	NNU4068	2	360	383	393	500	—	4	136
360	480	118	3	390	—	1 340	3 050	314	—	NNU4972	2	373	387	394	467	—	2.5	58.2
	540	134	5	—	493	1 560	3 090	315	NN3072	—	1	380	—	—	520	497	4	107
	540	180	5	407	—	2 430	5 050	503	—	NNU4072	2	380	403	413	520	—	4	142
	540	266	5	407	—	3 930	9 410	903	—	72NNU54266	2-P	380	403	413	520	—	4	219
	600	192	5	—	538	2 820	5 400	534	NN3172	—	1	380	—	—	580	543	4	218
380	570	300	4	423	—	4 970	11 700	1 100	—	76NNU57300	2-P	396	417	425	554	—	3	271
400	600	148	5	—	548	2 030	4 140	414	NN3080	—	1	420	—	—	580	552	4	146
	600	170	5	452	—	2 930	6 200	611	—	80NNU60170	2-P	420	447	458	580	—	4	172
	600	200	5	453	—	2 970	6 280	608	—	NNU4080	2	420	448	459	580	—	4	195
410	600	220	5	470	—	3 700	9 060	856	—	82DC60220	2-P	430	465	476	580	—	4	214

[Remark] The bearing number of the tapered bore type bearing is suffixed by K.

Double-row cylindrical roller bearings

d 420 ~ (670) mm



d	Boundary dimensions (mm)					Basic load ratings (kN)		Fatigue load limit (kN) C_u	Bearing No.		De-sign	Mounting dimensions (mm)						(Refer.) Mass (kg) Cylindrical bore
	D	B	$r_{min.}$	F_w	E_w	C_r	C_{0r}		NN Cylindrical bore	NNU Cylindrical bore		d_a min.	d_a max.	d_b min.	d_b max.	D_a min.	r_a max.	
420	560	140	4	460	—	1 670	4 290	413	—	NNU4984	2	436	457	465	544	—	3	96.7
	600	220	5	470	—	3 700	9 060	856	—	84DC60220	2-P	440	465	476	580	—	4	204
	620	150	5	—	570	2 310	4 570	449	NN3084	—	1	440	—	—	600	574	4	154
	620	200	5	473	—	3 050	6 570	629	—	NNU4084-1	2	440	468	479	600	—	4	203
430	750	280	7.5	515	—	6 040	12 100	1 110	—	86DC75280	2-P	462	508	521	718	—	6	539
440	600	160	4	487	—	2 060	5 000	477	—	NNU4988	2	456	483	492	584	—	3	133
	620	225	4	487	—	3 950	9 980	921	—	88DC62225	2-P	456	483	492	604	—	3	220
	650	212	6	493	—	3 430	7 530	707	—	NNU4088A	2	464	488	501	—	5	240	
	650	230	6	495	—	4 030	9 320	875	—	88NNU65230	2-P	464	489	502	626	—	5	265
460	620	160	4	502	—	2 250	5 440	516	—	NNU4992	2	476	498	507	604	—	3	136
480	680	280	6	527	—	5 160	12 900	1 150	—	96NNU68280	2-P	504	521	531	656	—	5	325
500	670	170	5	545	—	2 940	7 660	706	—	100DC67170A	2-P	520	541	551	650	—	4	171
	680	210	5	547	—	3 810	9 870	891	—	100NNU68210	2-P	520	542	552	660	—	4	225
	720	270	8	556	—	4 740	11 400	1 040	—	100DC72270A	2-P	532	551	565	688	—	6	353
	720	300	7	556	—	5 580	14 100	1 260	—	100DC72300B	2-P	532	551	561	688	—	5.5	405
508	749.3	355.6	6	566	—	7 350	18 300	1 600	—	102DC75356	2-P	532	560	573	725	—	5	540
560	735	170	5	604.6	—	3 040	7 730	694	—	112DC74170	2-P	580	598	609	715	—	4	194
	750	190	5	613	—	3 190	7 940	714	—	NNU49/560	2	580	608	619	730	—	4	233
600	800	200	5	652	—	3 500	8 630	762	—	NNU49/600	2	620	647	658	780	—	4	272
	870	200	6	—	801	3 940	8 450	746	NN30/600	—	1	624	—	—	846	807	5	388
630	780	150	4	671	—	2 430	6 800	591	—	NNU48/630	2	646	667	676	764	—	3	154
640	890	320	6	705	—	7 330	19 900	1 650	—	128DC89320	2-P	664	699	713	866	—	5	625
670	900	230	6	732	—	5 270	14 100	1 190	—	NNU49/670	2-P	694	726	740	876	—	5	420

[Remark] The bearing number of the tapered bore type bearing is suffixed by K.

Double-row cylindrical roller bearings

d (670) ~ 710 mm

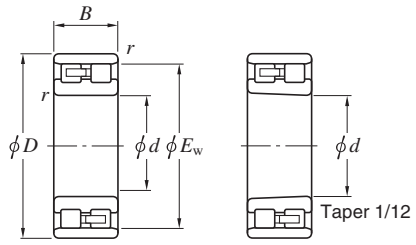

Cylindrical bore

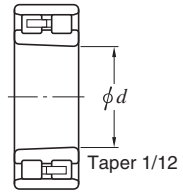

Tapered bore

Design 1 (NN type)

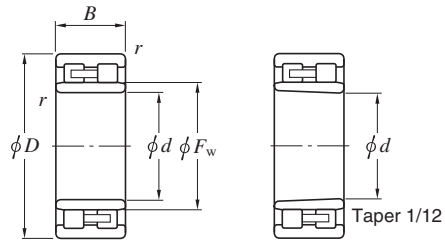

Cylindrical bore

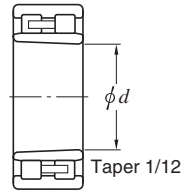

Tapered bore

Design 2 (NNU type)



Design 2-P (NNU type)

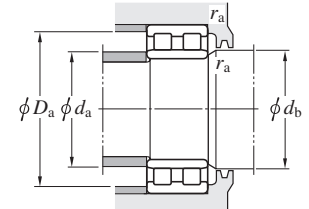
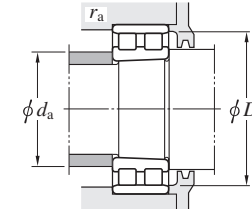

Boundary dimensions (mm)						Basic load ratings (kN)		Fatigue load limit (kN) C_u	Bearing No.		De- sign	Mounting dimensions (mm)						(Refer.) Mass (kg) Cylindrical bore
d	D	B	$r_{min.}$	F_w	E_w	C_r	C_{0r}		NN Cylindrical bore	NNU Cylindrical bore		d_a min.	d_a max.	d_b min.	d_b max.	D_a min.	r_a max.	
670	920	330	6	738	—	7 370	20 800	1 700	—	134NNU92330	2-P	694	732	746	896	—	5	662
710	950	243	6	775	—	5 890	16 200	1 350	—	NNU49/710	2-P	734	769	783	926	—	5	491

[Remark] The bearing number of the tapered bore type bearing is suffixed by K.

Four-row cylindrical roller bearings

d 100 ~ (160) mm

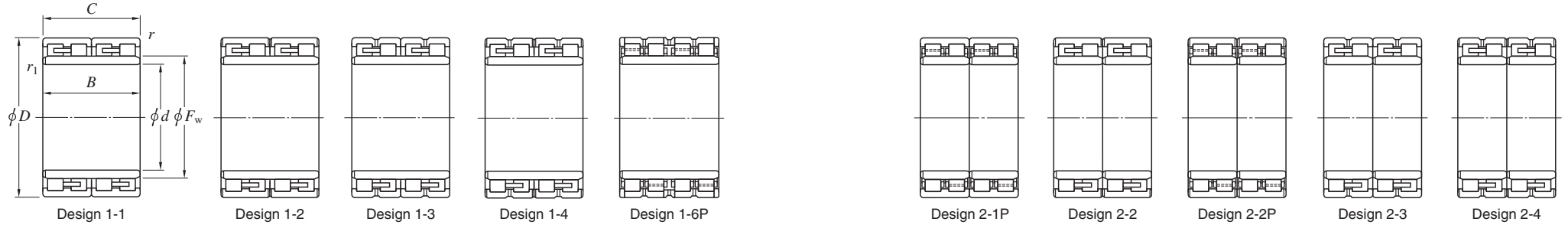

Boundary dimensions (mm)							Basic load ratings (kN)			Fatigue load limit (kN) C_u	Bearing No.	Design	Mounting dimensions (mm)					(Refer.) Mass (kg)
d	D	B	C	F_w	$r_{min.}$	$r_{1min.}$	C_r	C_{0r}	d_a min.				D_a max.	r_a max. ¹⁾	r_b max. ¹⁾			
100	140	120	120	110	1.1	1.1	607	945	134	20FC14120	2-2	107	133	131	1	1	5.6	
110	170	90	90	127	2	2	538	692	92.0	22FC1790	1-2	120	160	155	2	2	7.4	
	180	120	120	128	2	2	798	971	123			119	170	164	2	1.5		12
115	165	90	90	132.5	1.1	1.1	498	751	90.3	23FC1690	1-1	122	158	154	1	1	6.5	
120	165	87	87	134.5	1.1	1.1	468	745	95.2	24FC1787	1-2	127	158	154	1	1	5.6	
	180	105	105	135	2	1.1	613	796	96.7			4CR120	1-2	127	170	165		2
127	174.65	150.812	150.812	139.5	1.1	1.1	789	1 300	170	25FC17150	2-2	134	167	163	1	1	10.5	
	203.2	127	127	147	2	2	930	1 180	160			25FC20127	1-3	137	193	185		2
130	200	104	104	150	2	2	711	953	115	26FC20104	1-2	140	190	182	2	2	11.8	
	200	125	125	149	2	2	946	1 310	176			26FC20125	1-2	140	190	183		2
140	190	119	119	154	1.5	1.5	707	1 160	136	28FC19119W	1-3	149	181	178	1.5	1.5	9.6	
	210	116	116	158	2	2	848	1 120	131			28FC21116	1-2	150	200	194		2
145	210	155	155	166	1.1	1.1	1 060	1 710	223	29FC21155	1-2	152	203	196	1	1	17.8	
	225	156	156	169	2	2	1 150	1 680	219			313924	1-2	155	215	205		2
150	200	120	120	162	2	2	840	1 400	180	30FC20120	1-2	160	190	188	2	2	10.1	
	210	120	120	168.5	2	2	859	1 380	161	30FC21120	2-2	160	200	196	2	2	12.8	
	210	150	150	165	2	2	1 090	1 780	231	30FC21150	1-2	160	200	195	2	2	15.9	
	220	150	150	170	2	2	1 110	1 760	229	30FC22150	1-2	160	210	202	2	2	19.2	
	220	150	150	168	2	2	1 110	1 760	229	30FC22150A	1-2	160	210	200	2	2	19.5	
	230	156	156	174	2	2	1 210	1 810	238	313891-1	1-2	160	220	210	2	2	23.8	
160	220	180	180	177	2	2	1 210	2 170	271	32FC22180	1-2	170	210	205	2	2	20.5	
	230	130	130	180	2.1	2.1	1 090	1 740	217	314190	1-2	172	218	212	2	2	17.7	
	230	168	168	182	1.1	1.1	1 300	2 210	273	32FC23170	1-2	167	223	214	1	1	22.8	
	230	168	168	180	2	2	1 310	2 200	273	32FC23170A	1-2	170	220	212	2	2	23.1	

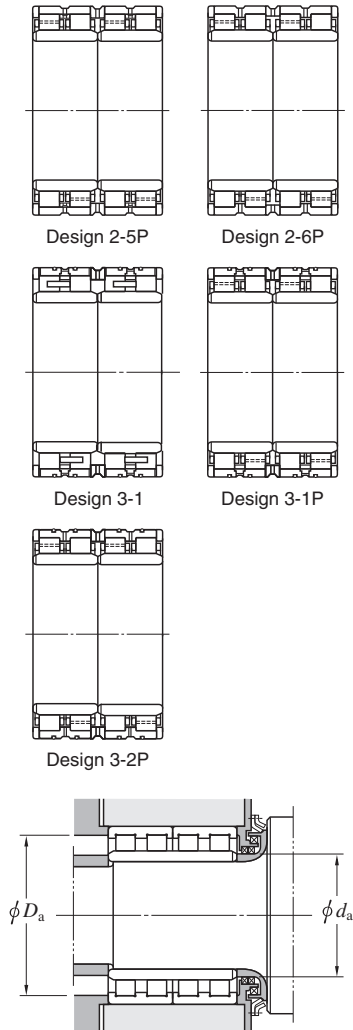

[Note] 1) r_a indicates housing chamfer dimension corresponding to outer ring chamfer dimension r .
 r_b indicates the shaft chamfer dimension corresponding to inner ring chamfer dimension r_1 .

Four-row cylindrical roller bearings

d (160) ~ (200) mm

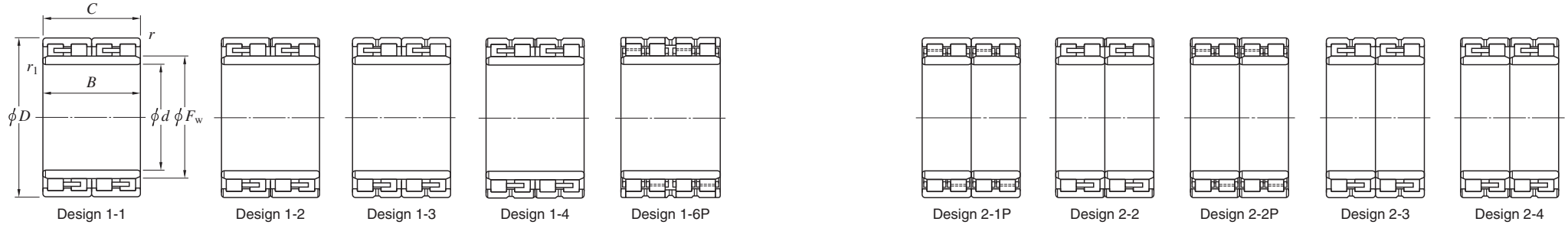

Boundary dimensions (mm)							Basic load ratings (kN)		Fatigue load limit (kN) C_u	Bearing No.	Design	Mounting dimensions (mm)					(Refer.) Mass (kg)		
d	D	B	C	F_w	r min.	r_1 min.	C_r	C_{0r}				d_a min.	D_a max.	r_a 1) max.	r_b 1) max.				
160	230	168	168	179	2	2	1 400	2 210	276	32FC23170B	1-4	170	220	215	2	2	22.6		
	230	180	180	177	2	2	1 430	2 270	282			32FC23180A	1-2	170	220	213	2	2	24.1
	240	120	120	183	2.1	2.1	831	1 140	128			32FC24120W	1-3	172	228	219	2	2	18.5
	240	170	170	183	2.1	2.1	1 480	2 220	279			32FC24170	1-2	172	228	223	2	2	26.8
170	230	120	120	187	2	2	976	1 680	208	34FC23120	1-2	180	220	215	2	2	14.4		
	240	156	156	190	2	2	1 220	2 050	256	34FC24156A		1-2	180	230	222	2	2	22.4	
	240	156	156	189	2	2	1 320	2 100	264	34FC24156B		1-2	180	230	225	2	2	21.8	
	240	190	190	187	1.5	1.5	1 580	2 620	317	34FC24190		1-2	179	231	223	1.5	1.5	26.9	
	250	168	168	192	2.1	2.1	1 470	2 230	277	34FC25168		1-2	182	238	232	2	2	27.6	
	250	170	170	192	2.1	2.1	1 470	2 230	277	34FC25170		1-2	182	238	232	2	2	27.8	
	260	150	150	195	2.1	2.1	1 380	2 000	253	34FC26150		1-2	182	248	237	2	2	28.8	
178	258.75	150	150	199	1.5	1.5	1 370	2 070	261	36FC26150	1-2	187	250	239	1.5	1.5	25.8		
180	250	156	156	200	2	2	1 310	1 980	271	36FC25156A	1-2	190	240	234	2	2	23.3		
	260	168	168	202	2.1	2.1	1 440	2 390	291	313812W		1-4	192	248	238	2	2	29.7	
	260	168	168	202	2.1	2.1	1 540	2 420	297	36FC26168		1-2	192	248	242	2	2	29.3	
	265	180	180	203	2	2	1 630	2 600	313	36FC27180		1-2	190	255	243	2	2	33.6	
190	260	168	168	212	2.1	2.1	1 430	2 600	309	38FC26168-1	1-2	202	248	244	2	2	26.5		
	270	170	170	212	2	2	1 430	2 310	283	38FC27170		1-2	200	260	250	2	2	30.8	
	270	170	170	213	2	2	1 430	2 310	283	38FC27170A		1-2	200	260	251	2	2	31.0	
	270	200	200	212	2	2	1 840	3 080	368	314199		1-2	200	260	252	2	2	36.1	
	280	200	200	214	2.1	2.1	1 940	3 100	370	38FC28200		1-2	202	268	258	2	2	42	
	290	190	190	215	2.1	2.1	1 950	2 860	340	38FC29190		1-2	202	278	265	2	2	44.9	
195	300	226	226	220	2.1	2.1	2 460	3 690	430	39FC30226	1-2	207	288	274	2	2	57.9		
200	270	170	170	222	2	2.1	1 480	2 780	324	314553	1-2	212	260	254	2	2	28.0		
	280	152	152	222	2.1	2.1	1 380	2 150	265	40FC28152BW		1-3	212	268	262	2	2	28.0	

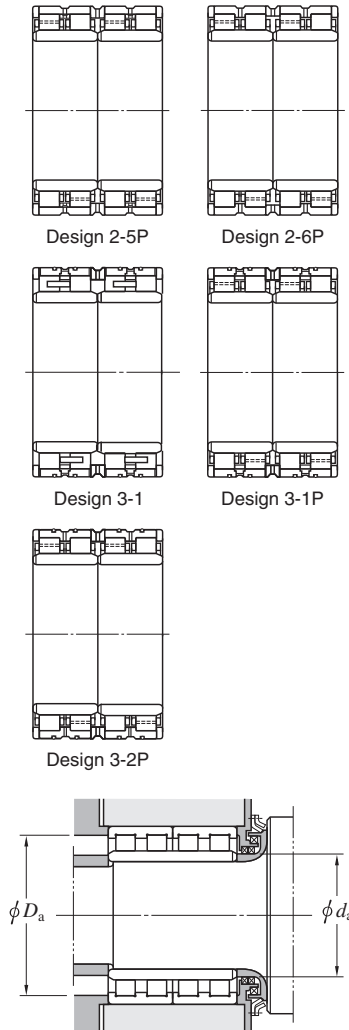

[Note] 1) r_a indicates housing chamfer dimension corresponding to outer ring chamfer dimension r .
 r_b indicates the shaft chamfer dimension corresponding to inner ring chamfer dimension r_1 .

Four-row cylindrical roller bearings

d (200) ~ (240) mm

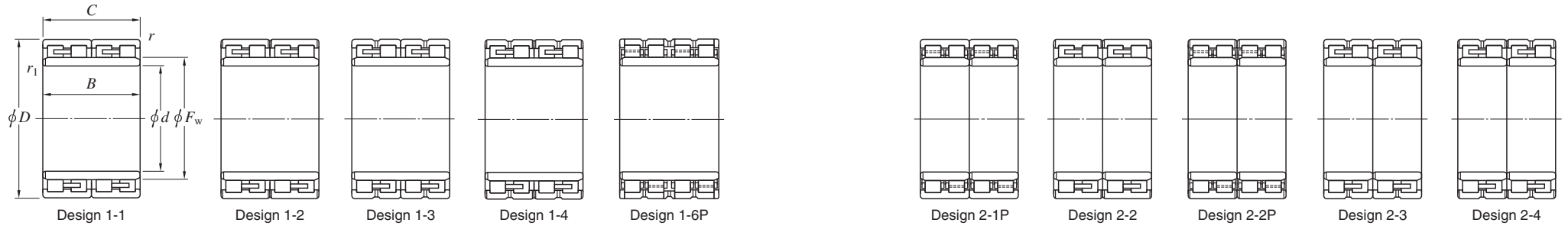

Boundary dimensions (mm)							Basic load ratings (kN)		Fatigue load limit (kN) C_u	Bearing No.	Design	Mounting dimensions (mm)					(Refer.) Mass (kg)	
d	D	B	C	F_w	r min.	r_1 min.	C_r	C_{0r}				d_a min.	D_a max.	r_a ¹⁾ max.	r_b ¹⁾ max.	Mass		
200	280	170	170	222	2.1	2.1	1 600	2 620	313	40FC28170	1-2	212	268	262	2	2	31.7	
	280	188	188	222	2.1	2.1	1 690	2 810	331		40FC28188	1-2	212	268	262	2	2	35.0
	280	190	190	223	3	3	1 820	3 100	359		40FC28190A	1-2	214	266	263	2.5	2.5	36.0
	280	200	200	222	2	2	1 820	3 090	365	313893-1	1-2	210	270	262	2	2	37.7	
	280	200	200	224	2.1	2.1	1 820	3 330	388	40FC28200	1-2	212	268	260	2	2	38.7	
	290	192	192	226	2.1	2.1	1 840	3 030	350	313811	1-2	212	278	268	2	2	42.0	
	310	160	160	232	2.1	2.1	1 590	2 240	274	40FC31160	1-1	212	298	282	2	2	44.6	
	310	206	206	227	2.1	2.1	2 260	3 240	387	40FC31206	1-2	212	298	283	2	2	56.6	
206	299.97	170	170	229	2	2	1 840	2 780	333	41FC30170	1-2	216	289	277	2	2	39.2	
210	290	192	192	236	2.1	2.1	1 820	3 270	372	42FC29192	1-2	222	278	274	2	2	38.1	
	300	210	210	234	2.1	2.1	2 080	3 490	407	42FC30210	1-2	222	288	278	2	2	47.3	
220	300	150	150	240	2.1	2.1	1 510	2 500	298	44FC30150W	1-3	232	288	280	2	2	30.7	
	310	192	192	247	2.1	2.1	1 910	3 270	369	313837-1	1-2	232	298	289	2	2	45.5	
	310	192	192	246	2	2	2 050	3 420	398	313837A	1-2	230	300	291	2	2	44.9	
	310	192	192	245	3	2.1	1 820	2 980	349	44FC31192W	1-3	232	296	289	2.5	2	43.9	
	310	225	225	244	2.1	2.1	2 360	4 160	467	44FC31225A	1-2	232	298	288	2	2	53.5	
	320	210	210	246	2.1	2.1	2 200	3 490	406	44FC32210	1-2	232	308	296	2	2	55.4	
	320	210	210	248	2.1	2.1	2 270	3 740	430	44FC32210-1	1-4	232	308	296	2	2	56.7	
	340	180	180	256	3	3	1 890	2 750	326	44FC34180A	1-4	234	326	310	2.5	2.5	59.0	
230	330	206	206	260	2.1	2.1	2 360	3 980	450	313824A	1-2	242	318	308	2	2	57.5	
	340	260	260	261	3	3	2 890	4 900	549	46FC34260	1-2	244	326	313	2.5	2.5	81.2	
237	339.67	200	200	264	2	2	2 310	3 780	432	47FC34200	1-2	247	329	314	2	2	58.0	
240	330	220	220	270	3	3	2 220	4 250	471	312943/1YD	1-4	254	316	310	2.5	2.5	55.5	
	330	220	220	264	2.1	2.1	2 300	4 120	462	48FC33220	1-2	252	318	308	2	2	54.3	
	330	220	220	268	3	3	2 210	4 070	454	48FC33220BW	1-4	254	316	310	2.5	2.5	55.5	
	330	250	250	263	2.1	2.1	2 700	4 910	546	48FC33250W	1-3	252	318	309	2	2	63.7	

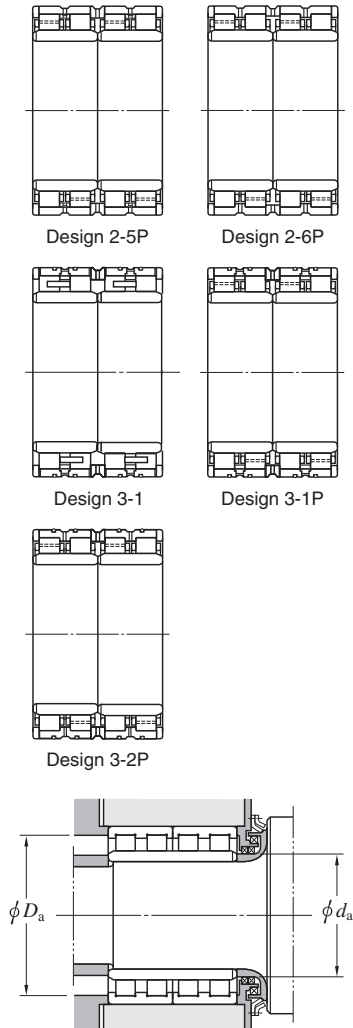

[Note] 1) r_a indicates housing chamfer dimension corresponding to outer ring chamfer dimension r .
 r_b indicates the shaft chamfer dimension corresponding to inner ring chamfer dimension r_1 .

Four-row cylindrical roller bearings

d (240) ~ (290) mm

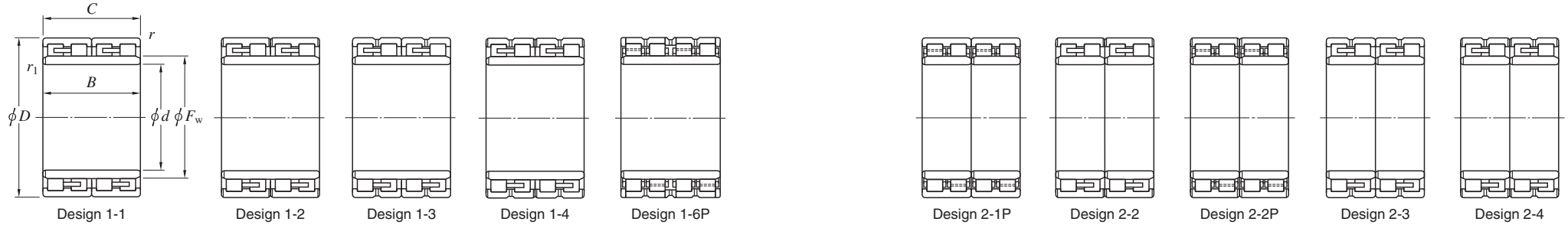

Boundary dimensions (mm)							Basic load ratings (kN)		Fatigue load limit (kN) C_u	Bearing No.	Design	Mounting dimensions (mm)					(Refer.) Mass (kg)
d	D	B	C	F_w	r min.	r_1 min.	C_r	C_{0r}				d_a min.	D_a max.	r_a 1) min.	r_b 1) max.	r_a 1) max.	
240	340	200	200	266	3	3	2 350	3 780	432	48FC34200	1-2	254	326	318	2.5	2.5	56.3
	340	220	220	268	3	3	2 510	4 240				472	48FC34220	1-2	254	326	318
250	350	220	220	278	3	3	2 420	4 200	467	50FC35220	1-2	264	336	326	2.5	2.5	64.6
260	355	260	260	286	2.1	2.1	2 860	5 440	591	52FC35260	2-2	272	343	332	2	2	75.0
	360	192	192	287	2.1	2.1	2 190	3 740	416	52FC36192W	1-3	272	348	335	2	2	59.8
	360	200	200	287	2.1	2.1	2 360	4 110	456	52FC36200	1-2	272	348	335	2	2	62.0
	360	230	230	292.5	2.1	2.1	2 680	4 900	528	52FC36230CW	1-4	272	348	340	2	2	69.7
	360	230	230	292	2.1	2.1	2 520	4 790	515	52FC36230D	1-2	272	348	336	2	2	72.6
	360	260	260	287	2.1	2.1	2 880	5 320	579	52FC36260	2-2	272	348	335	2	2	80.0
	368	268	268	288	2.1	2.1	3 430	5 990	645	52FC37268W	1-4	272	356	344	2	2	89.9
	370	220	220	292	3	3	2 500	4 330	476	313823	1-2	274	356	342	2.5	2.5	76.0
	370	220	220	290	3	3	2 730	4 480	497	313823A	1-2	274	356	346	2.5	2.5	75.0
265	370	234	234	292	1.5	1.5	2 870	4 910	536	53FC37234A	1-2	274	361	346	1.5	1.5	76.3
	370	234	234	300	1.5	1.5	2 830	5 290	579	53FC37234B	2-2	274	361	348	1.5	1.5	78.5
270	380	230	230	298	2.1	2.1	2 910	4 910	535	54FC38230	1-2	282	368	354	2	2	80.0
280	380	170	170	306	2.1	2.1	2 130	3 590	398	56FC38170W	1-3	292	368	356	2	2	55.0
	390	220	220	312	3	3	2 590	4 640	501	313822	1-2	294	376	362	2.5	2.5	81.8
	390	220	220	308	3	3	2 730	4 670	508	313822A	1-2	294	376	362	2.5	2.5	79.7
	390	220	220	306	3	2.1	3 160	5 350	575	313822C	1-2	292	376	364	2.5	2	79.7
	390	220	220	312	3	3	2 910	5 100	547	313822D	1-2	294	376	366	2.5	2.5	80.1
	390	240	240	312	3	3	3 070	5 620	608	56FC39240	1-2	294	376	364	2.5	2.5	88.1
	390	275	275	309	2.1	2.1	3 360	6 110	647	56FC39275B	1-2	292	378	363	2	2	100
	390	275	275	308	3	2.1	3 810	6 850	719	56FC39275J	2-4	292	376	366	2.5	2	102
	410	300	300	314	3	3	4 680	8 400	895	56FC41300	2-6P	294	396	378	2.5	2.5	137
	290	390	234	234	320	3	3	2 880	5 500	575	58FC39234	1-2	304	376	368	2.5	2.5

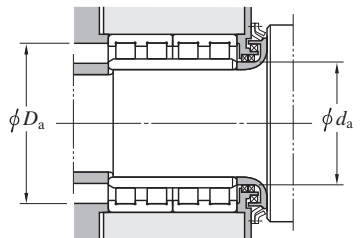

[Note] 1) r_a indicates housing chamfer dimension corresponding to outer ring chamfer dimension r .
 r_b indicates the shaft chamfer dimension corresponding to inner ring chamfer dimension r_1 .

Four-row cylindrical roller bearings

d (290) ~ (340) mm

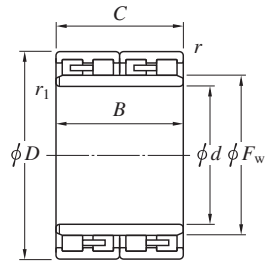

Design 1-1



Design 1-2



Design 1-3



Design 1-4



Design 1-6P



Design 2-1P

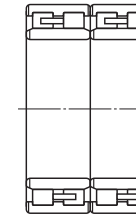

Design 2-2

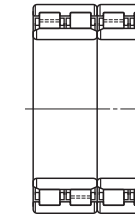

Design 2-2P

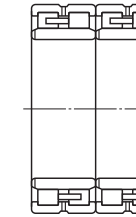

Design 2-3



Design 2-4

Boundary dimensions (mm)							Basic load ratings (kN)		Fatigue load limit (kN) C_u	Bearing No.	Design	Mounting dimensions (mm)					(Refer.) Mass (kg)
d	D	B	C	F_w	r min.	r_1 min.	C_r	C_{0r}				d_a min.	D_a max.	r_a ¹⁾ max.	r_b ¹⁾ max.		
290	400	180	180	320	3	3	2 350	4 010	434	58FC40180W	1-2	304	386	372	2.5	2.5	68.3
	410	240	240	320	3	3	3 270	5 540	589	58FC41240	1-2	304	396	380	2.5	2.5	99.0
	420	300	300	327	3	3	3 880	6 960	722	58FC42300	1-2	304	406	387	2.5	2.5	138
300	400	300	300	328	3	3	3 650	7 310	746	60FC40300A	1-2	314	386	378	2.5	2.5	103
	420	218	218	332	3	3	2 940	5 010	537	60FC42218	1-1	314	406	390	2.5	2.5	93.0
	420	240	240	332	3	3	3 330	5 750	606	60FC42240	1-1	314	406	392	2.5	2.5	102
	420	300	300	332	3	3	4 220	7 840	817	4CR300	3-2P	314	406	392	2.5	2.5	125
	420	300	300	331	1.5	1.5	4 280	7 750	805	60FC42300DW	2-4	309	411	395	1.5	1.5	127
	420	300	300	332	2	2	4 700	8 690	896	60FC42300L-2	2-6P	310	410	395	2	2	129
	420	300	300	332	3	3	4 070	7 270	749	60FC42300W	2-3	314	406	394	2.5	2.5	127
310	420	300	300	338	3	3	3 870	7 370	754	62FC42300	1-2	324	406	394	2.5	2.5	119
	430	240	240	344.5	3	3	3 310	5 770	602	62FC43240	1-2	324	416	404	2.5	2.5	105
	440	240	240	341	3	3	3 530	5 730	604	62FC44240	1-2	324	426	409	2.5	2.5	113
320	440	230	230	351	3	3	3 170	5 490	574	64FC44230/240	1-2	334	426	411	2.5	2.5	103
	450	240	240	358	3	3	3 380	5 740	603	4CR320	1-2	334	436	422	2.5	2.5	119
	450	240	240	355	3	3	3 390	5 730	604	64FC45240	1-2	334	436	419	2.5	2.5	117
	450	240	240	358	3	3	3 470	5 930	623	64FC45240CW	1-4	334	436	422	2.5	2.5	118
	460	340	340	360	3	3	4 840	8 730	890	64FC46340A	1-4	334	446	428	2.5	2.5	187
	480	290	290	361	4	4	5 120	8 450	883	64FC48290	2-6P	338	462	441	3	3	189
	480	350	350	364	2.1	2.1	6 290	11 000	1 120	314274A	2-6P	332	468	444	2	2	227
330	440	200	200	358	3	3	2 920	5 220	553	66FC44200AW	1-3	344	426	414	2.5	2.5	83.4
	440	200	200	360	3	5	2 570	4 670	490	66FC44200W	1-3	352	426	412	2.5	4	83.0
	460	340	340	364	2.1	2.1	4 840	9 150	926	66FC46340	1-2	342	448	428	2	2	172
	460	340	340	368	4	4	5 090	9 800	978	66FC46340B	1-2	348	442	432	3	3	176
	460	380	380	364	2.1	2.1	5 490	10 800	1 070	66FC46380W	1-4	342	448	428	2	2	195
340	445	250	250	367	2.1	4	3 140	6 110	626	68FC45250W	1-3	358	433	419	2	3	100
	450	250	250	368	2.1	2.1	3 430	6 480	672	68FC45250BW	1-3	352	438	424	2	2	106

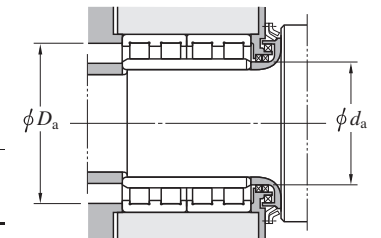
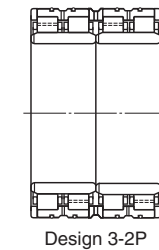
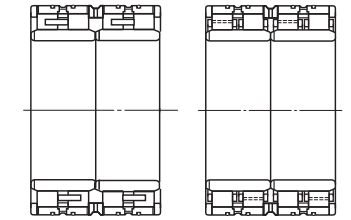
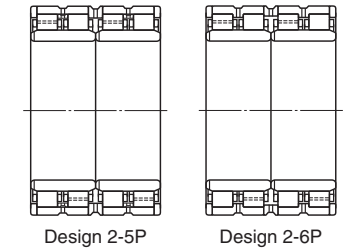

[Note] 1) r_a indicates housing chamfer dimension corresponding to outer ring chamfer dimension r .
 r_b indicates the shaft chamfer dimension corresponding to inner ring chamfer dimension r_1 .

Four-row cylindrical roller bearings

d (340) ~ 390 mm

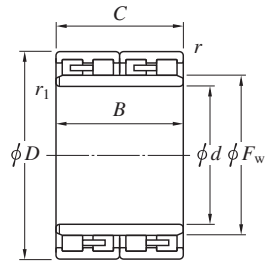

Design 1-1



Design 1-2



Design 1-3



Design 1-4



Design 1-6P

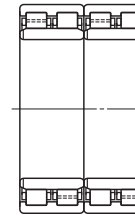

Design 2-1P

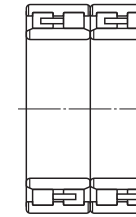

Design 2-2

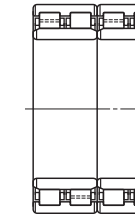

Design 2-2P

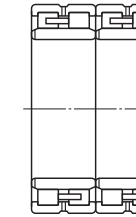

Design 2-3



Design 2-4

Boundary dimensions (mm)							Basic load ratings (kN)		Fatigue load limit (kN) C_u	Bearing No.	Design	Mounting dimensions (mm)					(Refer.) Mass (kg)		
d	D	B	C	F_w	r min.	r_1 1)	C_r	C_{0r}				d_a min.	d_a max.	r_a 2) min.	r_a 2) max.	r_b 2) max.			
340	480	350	350	378	4	SP	5 740	11 100	1 100	68FC48350-2	2-4	354	462	446	3	2	211		
	480	350	350	378	3	SP	5 990	11 500	1 150			68FC48350D	3-2P	354	466	448	2.5	2	201
	480	350	350	376	4	4	6 070	11 400	1 150			68FC48350L	3-2P	358	462	448	3	3	201
	480	385	350	378	2.1	SP	5 990	11 500	1 150			68FC48350N	2-6P	358	468	448	2	3	209
	490	300	300	380	5	5	4 390	7 690	784			68FC49300	1-2	362	468	450	4	4	187
490	300	300	379	5	5	4 610	7 850	797	68FC49300A	1-2	362	468	453	4	4	182			
343.052	457.098	254	254	374	3	3	3 300	6 190	632	69FC46254W	1-4	358	443	430	2.5	2.5	112		
350	500	460	460	388	2	2	8 230	16 500	1 610	70FC50460	2-6P	360	490	464	2	2	296		
360	480	290	290	392	3	3	4 330	8 510	842	72FC48290	1-2	374	466	452	2.5	2.5	145		
	500	250	250	394	3	3	4 390	7 340	756	72FC50250	2-2	374	486	470	2.5	2.5	145		
	510	370	370	400	4	4	5 750	11 000	1 090	72FC51370	1-2	378	492	470	3	3	241		
	520	380	380	405	2	5	7 270	13 700	1 350	72FC52380	2-6P	382	510	485	2	4	270		
370	520	380	380	409	5	5	6 660	13 200	1 300	74FC52380	2-6P	392	498	481	4	4	257		
	520	400	400	413	5	5	5 930	11 900	1 150	74FC52400W	2-4	392	498	481	4	4	268		
	540	400	400	415	4	4	6 500	11 500	1 130	74FC54400A	1-2	388	522	499	3	3	311		
375	545	400	400	417	4	4	7 920	14 500	1 410	75FC55400	3-2P	393	527	505	3	3	315		
380	520	280	280	417	4	4	4 660	8 550	850	76FC52280	1-2	398	502	487	3	3	173		
	520	290	290	418	4	4	4 700	8 840	878	76FC52290	1-2	398	502	486	3	3	181		
	540	300	300	421	3	3	5 820	10 100	1 010	76FC54300	2-6P	394	526	505	2.5	2.5	222		
	540	340	340	422	4	4	5 760	10 300	1 010	76FC54340W	3-1	398	522	502	3	3	256		
	540	360	360	422	4	4	6 870	12 900	1 260	76FC54360	2-6P	398	522	502	3	3	266		
	540	400	380	422	4	4	7 530	14 300	1 400	76FC54380	2-6P	398	522	504	3	3	287		
	540	400	400	422	4	4	7 560	14 600	1 410	76FC54400BW	2-6P	398	522	502	3	3	298		
	540	400	400	422	4	4	7 560	14 600	1 410	76FC54400DW	3-2P	398	522	502	3	3	298		
	390	550	400	400	434	5	SP	6 430	12 400	1 190	78FC55400AW	2-3	410	528	510	4	4	296	

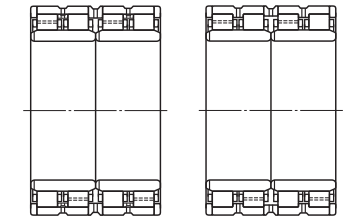

Design 2-5P

Design 2-6P

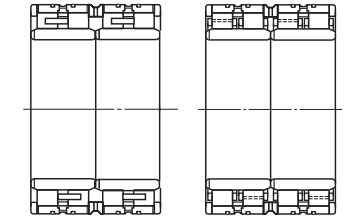

Design 3-1

Design 3-1P

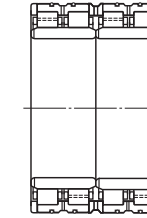

Design 3-2P

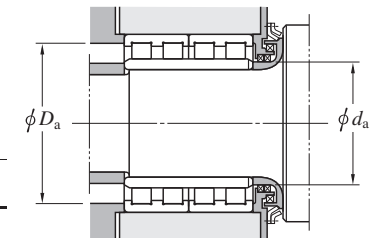

[Notes] 1) SP indicates the specially chamfered form.
2) r_a indicates housing chamfer dimension corresponding to outer ring chamfer dimension r .
 r_b indicates the shaft chamfer dimension corresponding to inner ring chamfer dimension r_1 .

Four-row cylindrical roller bearings

d 400 ~ 444.5 mm

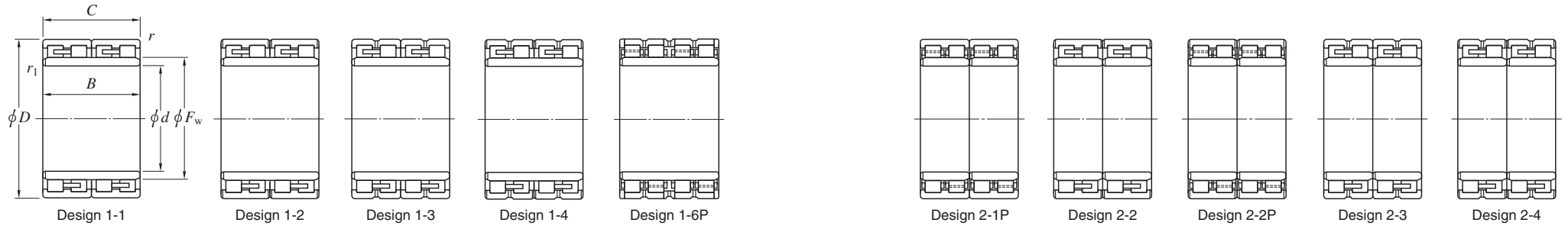

Boundary dimensions (mm)							Basic load ratings (kN)		Fatigue load limit (kN) C_u	Bearing No.	Design	Mounting dimensions (mm)					(Refer.) Mass (kg)
d	D	B	C	F_w	r min.	r_1 min.	C_r	C_{0r}				d_a min.	D_a max.	r_a ¹⁾ max.	r_b ¹⁾ max.		
400	520	250	250	432	4	4	3 650	7 050	698	80FC52250W	1-3	418	502	492	3	3	133
	560	360	360	441	5	5	6 980	13 400	1 290	80FC56360	2-6P	422	538	521	4	4	277
	560	410	410	445	5	5	7 930	15 800	1 500	4CR400	3-2P	422	538	525	4	4	310
	560	410	410	445	2	5	8 100	16 300	1 540	80FC56410	2-6P	422	550	525	2	4	315
	600	380	380	450	5	5	8 310	14 300	1 400	80FC60380	2-6P	422	578	552	4	4	388
406.4	609.6	304.8	304.8	460	5	5	5 500	8 750	868	81FC6130W	1-4	429	587	556	4	4	307
410	546	400	400	448	5	5	6 260	13 000	1 240	82FC55400	2-2	432	524	516	4	4	256
	600	440	440	460	5	5	10 100	18 800	1 780	82FC60440	2-6P	432	578	560	4	4	432
418.5	600	410	410	470	5	5	8 300	15 700	1 500	84FC60410A	2-6P	441	578	560	4	4	385
419	592	350	350	462	4	4	7 120	12 900	1 250	84FC59350	1-6P	437	574	552	3	3	304
420	560	280	280	457	4	4	4 900	9 410	913	84FC56280	1-1	438	542	527	3	3	189
	560	400	400	458	4	4	6 080	12 700	1 200	84FC56400	2-4	438	542	526	3	3	270
	580	320	320	463	4	4	5 960	11 000	1 070	84FC58320	2-4	438	562	543	3	3	249
	600	440	440	470	5	5	9 080	17 700	1 670	4CR420A	3-1P	442	578	560	4	4	420
430	591	420	420	472	5	5	8 200	16 800	1 570	86FC59420	2-2P	452	569	552	4	4	345
	591	420	420	476	4	4	8 150	17 400	1 610	86FC59420-2	2-6P	448	573	552	3	3	349
	591	420	420	476	4	4	7 390	14 700	1 380	86FC59420A-1	1-3	448	573	552	3	3	340
	600	450	450	475	5	5	9 350	19 300	1 800	86FC60450	2-6P	452	578	559	4	4	405
440	590	270	270	482	4	4	4 530	8 460	830	88FC59270W	1-3	458	572	554	3	3	207
	620	450	450	487	4	4	9 900	20 000	1 840	4CR440	3-1P	458	602	577	3	3	440
	620	450	450	487	4	4	9 900	20 000	1 840	88FC62450AW	2-6P	458	602	577	3	3	440
	640	420	420	492	5	5	9 810	18 400	1 740	88FC64420	2-6P	462	618	592	4	4	470
	720	452	452	512	6	6	10 800	16 600	1 590	88FC72452	1-6P	468	692	652	5	5	740
444.5	660.4	323.85	323.85	500	4	4	7 590	12 600	1 210	89FC66324	1-6P	463	642	608	3	3	400

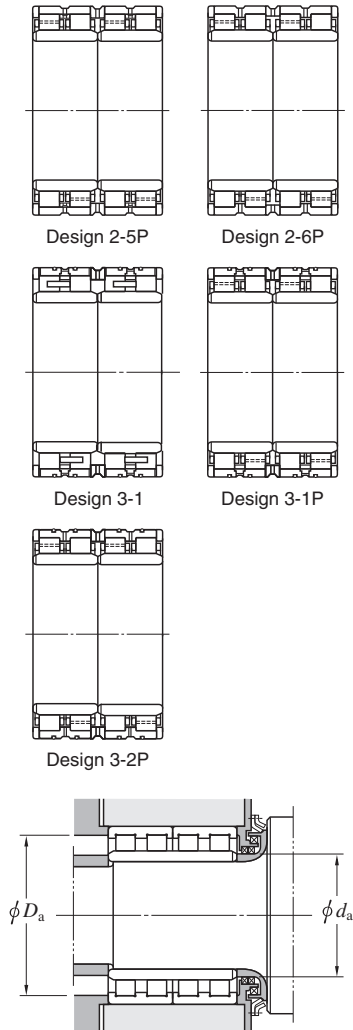

[Note] 1) r_a indicates housing chamfer dimension corresponding to outer ring chamfer dimension r .
 r_b indicates the shaft chamfer dimension corresponding to inner ring chamfer dimension r_1 .

Four-row cylindrical roller bearings

d 445 ~ 500 mm

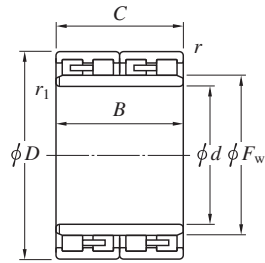

Design 1-1



Design 1-2

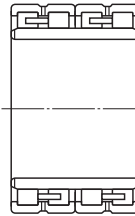

Design 1-3



Design 1-4



Design 1-6P

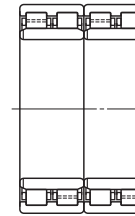

Design 2-1P

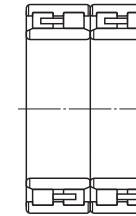

Design 2-2

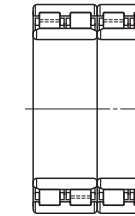

Design 2-2P

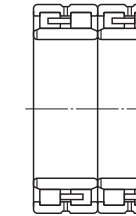

Design 2-3



Design 2-4

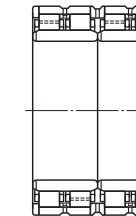

Design 2-5P

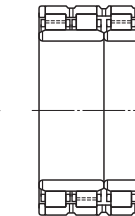

Design 2-6P

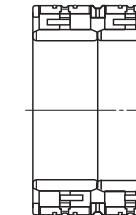

Design 3-1



Design 3-1P

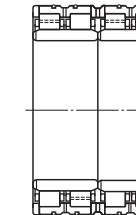

Design 3-2P

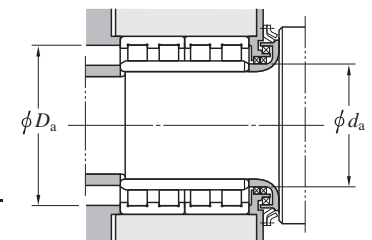

Boundary dimensions (mm)							Basic load ratings (kN)		Fatigue load limit (kN) C _u	Bearing No.	Design	Mounting dimensions (mm)					(Refer.) Mass (kg)
d	D	B	C	F _w	r ¹⁾ min.	r ₁ ¹⁾ min.	C _r	C _{0r}				d _a min.	D _a max.	r _a ²⁾ min.	r _a ²⁾ max.	r _b ²⁾ max.	
445	635	375	375	496	4	4	7 820	14 600	1 390	4CR445	3-1P	463	617	588	3	3	385
450	630	450	450	500	4	4	8 540	16 600	1 540	90FC63450A	2-2	468	612	590	3	3	433
460	600	400	400	497	4	SP	6 630	14 300	1 320	92FC60400	2-4	478	582	567	3	3	287
	620	400	400	504	4	4	8 560	18 200	1 660	4CR460C	3-1P	478	602	584	3	3	350
	620	400	400	502	4	4	8 140	17 000	1 580	92FC62400BW	1-6P	478	602	582	3	3	350
	620	400	400	502	4	4	7 380	14 800	1 370	92FC62400D	1-4	478	602	583	3	3	340
	650	470	470	509	6	6	11 300	22 200	2 050	92FC65470W	1-6P	488	622	609	5	5	494
	660	500	500	512	4	4	11 700	23 300	2 130	4CR460	3-1P	478	642	612	3	3	590
	660	500	500	510	5	5	12 000	23 400	2 140	92FC66500	2-6P	482	638	614	4	4	573
680	400	400	504	4	4	9 940	16 600	1 590	4CR460D	3-1P	478	662	624	3	3	510	
480	650	450	450	525	5	5	10 600	22 400	2 040	96FC65450B	2-6P	502	628	615	4	4	440
	650	460	460	526	5	5	9 660	20 800	1 890	96FC65460	2-6P	502	628	610	4	4	443
	680	460	460	532	5	5	10 800	21 300	1 950	96FC68460	2-6P	502	658	632	4	4	545
	680	500	500	534	5	5	10 800	22 000	1 990	4CR480	3-1P	502	658	630	4	4	580
	680	500	500	534	5	5	10 800	22 000	1 990	4CR480B	3-2P	502	658	630	4	4	580
	680	500	500	532	5	5	12 000	24 300	2 190	96FC68500A	2-6P	502	658	632	4	4	595
495	615	360	360	530	SP	SP	5 060	12 000	1 100	99FC62360	2-4	511	597	586	3	3	235
500	670	450	450	540	5	SP	10 600	22 500	2 020	100FC67450A-3	2-6P	522	648	630	4	4	451
	680	420	405	550	5	5	8 380	17 600	1 610	100FC68405	2-6P	522	658	634	4	4	442
	680	450	450	542.5	4	4	11 300	23 100	2 110	100FC68450	2-6P	518	662	639	3	3	495
	690	510	510	550	5	5	11 700	24 600	2 200	100FC69510A	3-2P	522	668	646	4	4	562
	710	480	480	558	6	6	12 200	24 800	2 220	100FC71480	2-6P	528	682	662	5	5	631
	720	400	400	558	5	6	10 400	18 900	1 750	100FC72400	1-6P	528	698	672	4	5	549
	720	530	530	560	6	6	13 600	26 500	2 370	100FC72530	2-6P	528	692	674	5	5	725
	720	530	530	568	5	4	13 700	28 900	2 580	100FC72530C	2-6P	518	698	672	4	3	742
	720	530	530	560	6	6	13 600	26 500	2 370	100FC72530W	3-2P	528	692	674	5	5	725

[Notes] 1) SP indicates the specially chamfered form.

2) r_a indicates housing chamfer dimension corresponding to outer ring chamfer dimension r.

r_b indicates the shaft chamfer dimension corresponding to inner ring chamfer dimension r₁.

Four-row cylindrical roller bearings

d 510 ~ (600) mm

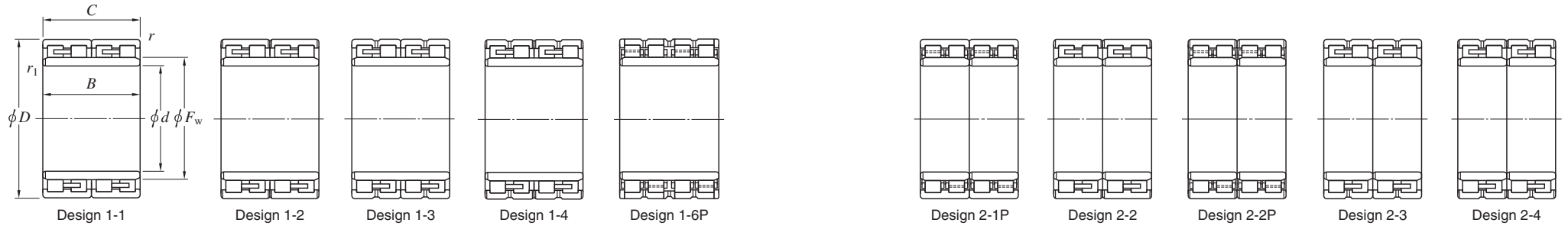

Boundary dimensions (mm)							Basic load ratings (kN)		Fatigue load limit (kN) C _u	Bearing No.	Design	Mounting dimensions (mm)					(Refer.) Mass (kg)		
d	D	B	C	F _w	r min.	r ₁ ¹⁾ min.	C _r	C _{0r}				d _a min.	D _a max.	r _a ²⁾ min.	r _a ²⁾ max.	r _b ²⁾ max.			
510	670	320	320	554	5	5	6 950	14 300	1 310	102FC67320	1-6P	532	648	634	4	4	305		
	670	450	450	550	5	5	10 400	23 400	2 100			102FC67450	2-6P	532	648	634	4	4	433
520	680	450	450	562	5	5	9 760	22 300	1 980	104FC68450W	2-6P	542	658	642	4	4	435		
	735	535	535	574.5	5	5	13 200	27 200	2 400			104FC74535	2-5P	542	713	680	4	4	738
	735	535	535	574.5	5	5	13 400	27 500	2 420			104FC74535C	3-2P	542	713	682	4	4	735
530	760	520	520	589	6	SP	14 400	28 800	2 520	106FC76520A	2-6P	548	732	705	5	2.5	810		
	780	570	570	595	6	6	15 600	30 600	2 710			106FC78570	2-6P	558	752	719	5	5	957
	780	570	570	595	6	6	15 600	30 600	2 710			106FC78570B	3-2P	558	752	719	5	5	960
536.17	762.03	558.8	558.8	598	5	SP	14 200	29 100	2 530	107FC76559AW	2-6P	559	740	710	4	4	825		
545	810	580	580	614	6	6	16 500	32 100	2 820	4CR545	3-1P	573	782	744	5	5	1 090		
550	740	510	510	600	6	6	13 000	28 100	2 440	110FC74510	2-6P	578	712	700	5	5	635		
560	780	570	570	616	5	2.1	15 500	33 100	2 870	112FC78570	2-6P	572	758	727	4	2	865		
	800	600	600	620	7.5	7.5	16 300	33 400	2 890			112FC80600	2-6P	596	764	740	6	6	1 010
	820	600	600	625	6	6	18 400	36 300	3 130			112FC82600	2-6P	588	792	759	5	5	1 120
570	800	514	514	626	6	6	14 600	29 200	2 550	114FC80514A	2-6P	598	772	746	5	5	829		
	815	594	594	628	6	6	16 400	32 100	2 810			114FC81594	2-6P	598	787	758	5	5	1 010
571.1	812.97	594	594	636	6	6	16 800	35 100	3 010	114FC81594A	2-6P	600	784	756	5	5	1 030		
590	820	590	590	649	6	SP	16 400	35 100	3 010	118FC82590	2-6P	621	792	765	5	5	990		
600	820	575	575	660	5	5	16 300	36 000	3 060	120FC82575B	2-6P	622	798	772	4	4	925		
	820	575	575	660	5	5	16 300	36 000	3 060			120FC82575C	3-2P	622	798	772	4	4	920
	850	600	600	664	4	4	18 300	38 100	3 230	120FC85600	3-2P	618	832	792	3	3	1 120		
	870	578	540	672	6	SP	16 600	32 300	2 770			120FC87540A	2-6P	628	842	808	5	5	1 120
	870	640	640	672	6	6	19 600	40 000	3 360	120FC87640	2-6P	628	842	808	5	5	1 320		
	870	640	640	669	5	5	19 600	40 000	3 360			4CR600	3-1P	622	848	805	4	4	1 310

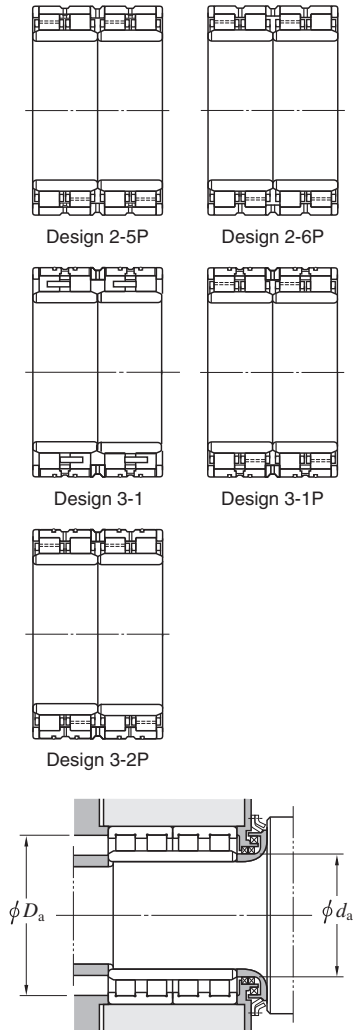

[Notes] 1) SP indicates the specially chamfered form.

2) r_a indicates housing chamfer dimension corresponding to outer ring chamfer dimension r.
r_b indicates the shaft chamfer dimension corresponding to inner ring chamfer dimension r₁.

Four-row cylindrical roller bearings

d (600) ~ 730 mm

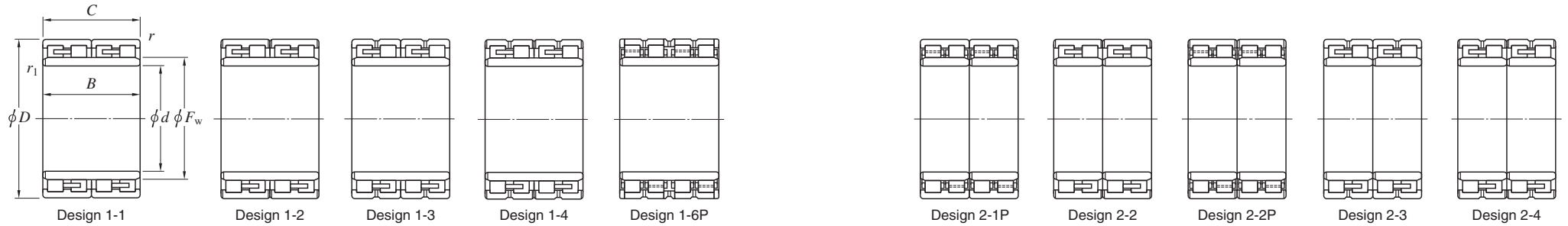

Boundary dimensions (mm)							Basic load ratings (kN)		Fatigue load limit (kN) C_u	Bearing No.	Design	Mounting dimensions (mm)					(Refer.) Mass (kg)
d	D	B	C	F_w	r min.	$r_1^{1)}$ min.	C_r	C_{0r}				d_a min.	d_a max.	D_a min.	$r_a^{2)}$ max.	$r_b^{2)}$ max.	
600	870	640	640	682	4	4	19 400	40 800	3 410	4CR600A 4CR600B	2-6P 2-6P	618	852	812	3	3	1 330
	870	640	640	669	5	5	19 600	40 000	3 360			622	848	805	4	4	1 310
610	850	570	570	670	6	6	16 500	34 900	2 990	122FC85570 122FC87660	2-6P 2-6P	638	822	790	5	5	1 040
	870	660	660	680	6	6	19 000	40 300	3 360			638	842	808	5	5	1 310
630	800	360	360	675	5	5	8 600	19 500	1 700	126FC80360	2-6P	652	778	759	4	4	440
640	880	600	600	700	6	6	18 800	40 800	3 400	128FC88600	2-5P	668	852	824	5	5	1 130
650	920	670	670	723	7.5	7.5	21 000	45 500	3 770	130FC92670	2-6P	686	884	855	6	6	1 450
	920	670	670	724	7.5	7.5	21 000	45 500	3 770	130FC92670A	2-6P	686	884	856	6	6	1 480
	920	690	690	724	7.5	7.5	21 000	45 500	3 770	130FC92690	2-6P	686	884	856	6	6	1 490
660	820	440	440	708	4	4	9 090	22 700	1 910	132FC82440W 132FC89670	2-4 2-6P	678	802	784	3	3	513
	889.75	670	670	718	6	6	19 600	46 900	3 840			688	861	830	5	5	1 240
665	968.6	732	732	734.5	6	SP	26 600	53 300	4 350	133FC97732	2-6P	693	940	899	5	5	1 870
680	1 020	680	680	775	5	SP	25 200	49 200	4 070	4CR680D	3-2P	719	998	946	4	8	2 040
690	980	715	715	767.5	7.5	7.5	22 900	48 800	3 990	138FC98715	2-6P	726	944	911	6	6	1 660
	980	750	750	766	6	7.5	24 100	52 300	4 240	138FC98750	3-2P	726	952	910	5	6	1 860
	980	750	750	766	6	7.5	24 100	52 300	4 240	138FC98750A	2-6P	726	952	910	5	6	1 860
700	980	700	700	774	6	6	22 300	48 200	3 940	140FC98700	2-6P	728	952	914	5	5	1 680
	980	700	700	774	6	6	22 300	48 200	3 940	140FC98700A	3-2P	728	952	914	5	5	1 680
	980	700	700	766	4	4	24 100	51 300	4 180	140FC98700C	2-6P	718	962	914	3	3	1 710
	1 000	710	710	770	4	4	23 700	47 400	3 920	140FC100710W	2-6P	718	982	930	3	3	1 810
710	929.9	645	635	767	5	5	19 400	47 000	3 810	142FC93635	2-6P	732	907	879	4	4	1 170
730	1 030	750	750	809	6	6	27 100	59 500	4 700	146FC103750	2-6P	758	1 002	961	5	5	2 060
	1 050	693	670	804	6	6	26 000	51 200	4 200	146FC105670	2-6P	758	1 022	978	5	5	1 980

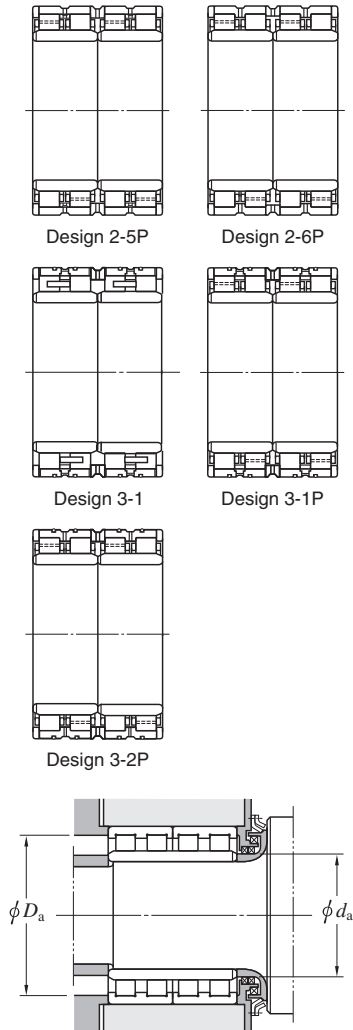

[Notes] 1) SP indicates the specially chamfered form.

2) r_a indicates housing chamfer dimension corresponding to outer ring chamfer dimension r .
 r_b indicates the shaft chamfer dimension corresponding to inner ring chamfer dimension r_1 .

Four-row cylindrical roller bearings

d 750 ~ (850) mm

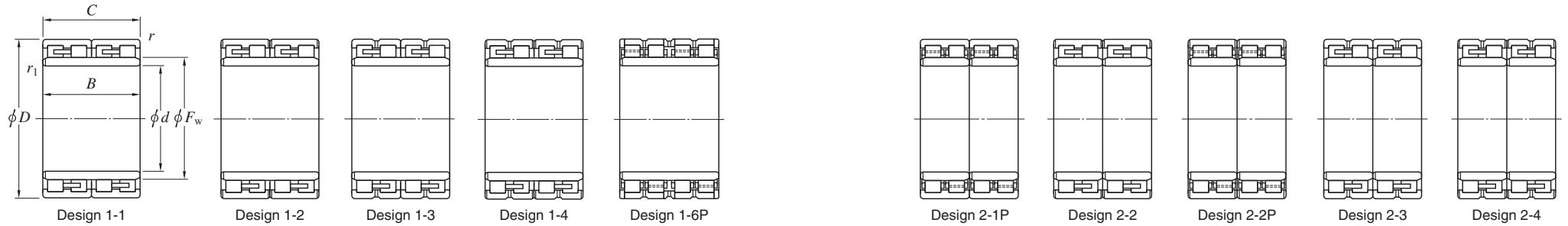

Boundary dimensions (mm)							Basic load ratings (kN)		Fatigue load limit (kN) C_u	Bearing No.	Design	Mounting dimensions (mm)					(Refer.) Mass (kg)
d	D	B	C	F_w	r min.	r_1 min.	C_r	C_{0r}				d_a min.	d_a max.	D_a min.	r_a ¹⁾ max.	r_b ¹⁾ max.	
750	1 000	670	670	813	6	6	22 900	54 200	4 300	150FC100670	2-6P	778	972	941	5	5	1 520
	1 020	630	620	816	6	6	22 000	48 300	3 880			778	992	956	5	5	1 550
755	1 070	750	750	837	7.5	7.5	28 000	60 300	4 740	151FC107750A	3-2P	791	1 034	997	6	6	2 240
760	1 015	700	700	832	7.5	7.5	22 400	54 200	4 270	152FC102700	2-5P	796	979	956	6	6	1 590
	1 030	750	750	828	7.5	7.5	25 700	61 100	4 760	152FC103750	2-6P	796	994	962	6	6	1 870
	1 079.5	787	787	846	7.5	7.5	28 400	61 700	4 810	152FC108787B	2-6P	796	1 043	1 006	6	6	2 380
	1 079.5	787	787	846	7.5	7.5	29 800	65 700	5 210	152FC108787D	3-2P	796	1 043	1 006	6	6	2 420
	1 080	805	790	847	6	6	28 400	61 700	4 810	4CR760	3-1P	788	1 052	1 007	5	5	2 440
761.425	1 079.602	787.4	787.4	846	7.5	7.5	29 800	65 700	5 210	152FC108787C	2-6P	798	1 043	1 006	6	6	2 420
765	1 010	718	708	827	6	6	23 900	58 000	4 540	153FC101708A	2-6P	793	982	953	5	5	1 610
	1 065	662	652	840	6	6	24 100	51 700	4 180	153FC107652	2-6P	793	1 037	992	5	5	1 870
770	1 075	770	770	847	7.5	6	29 000	63 500	4 950	154FC108770	3-2P	798	1 039	1 007	6	5	2 240
	1 075	770	770	847	7.5	6	29 000	63 500	4 950	154FC108770A	2-6P	798	1 039	1 007	6	5	2 250
	1 080	650	650	845	6	6	25 200	52 000	4 210	154FC108650	2-6P	798	1 052	1 010	5	5	1 930
780	1 070	780	780	852	6	6	28 500	65 100	5 140	156FC107780A	2-6P	808	1 042	1 002	5	5	2 140
790	1 015.9	610	610	850	6	6	19 400	48 800	3 830	158FC102610	2-6P	818	987	962	5	5	1 290
800	1 080	750	750	880	6	6	23 000	55 000	4 310	160FC108750	2-6P	828	1 052	1 010	5	5	2 020
820	1 130	650	650	891	6	6	25 800	53 700	4 310	164FC113650	2-6P	848	1 102	1 059	5	5	2 030
	1 130	800	800	903	7.5	7.5	29 300	66 900	5 110	164FC113800A	3-2P	856	1 094	1 059	6	6	2 510
	1 130	800	800	903	7.5	7.5	29 300	66 900	5 110	164FC113800D	2-6P	856	1 094	1 059	6	6	2 510
840	1 160	840	840	920	7.5	7.5	33 100	76 000	5 830	168FC116840B	2-6P	876	1 124	1 084	6	6	2 800
850	1 150	840	840	928	6	6	32 000	77 700	5 900	170FC115840	2-6P	878	1 122	1 078	5	5	2 620
	1 180	650	650	945	7.5	7.5	23 900	51 300	4 050	170FC118650	2-5P	886	1 144	1 105	6	6	2 190

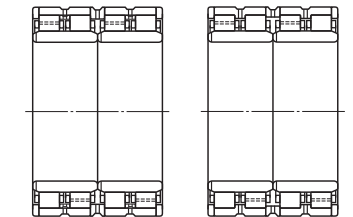

Design 2-3 Design 2-4

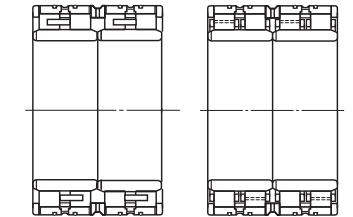

Design 2-5P Design 2-6P

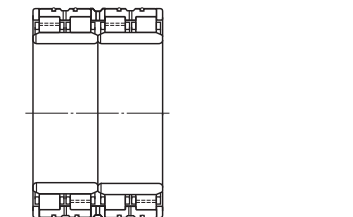

Design 3-1 Design 3-1P

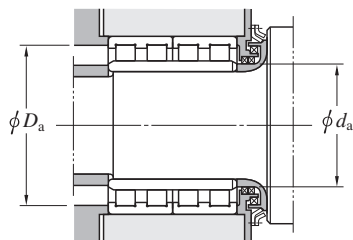

[Note] 1) r_a indicates housing chamfer dimension corresponding to outer ring chamfer dimension r .
 r_b indicates the shaft chamfer dimension corresponding to inner ring chamfer dimension r_1 .

Four-row cylindrical roller bearings

d (850) ~ 1 000 mm

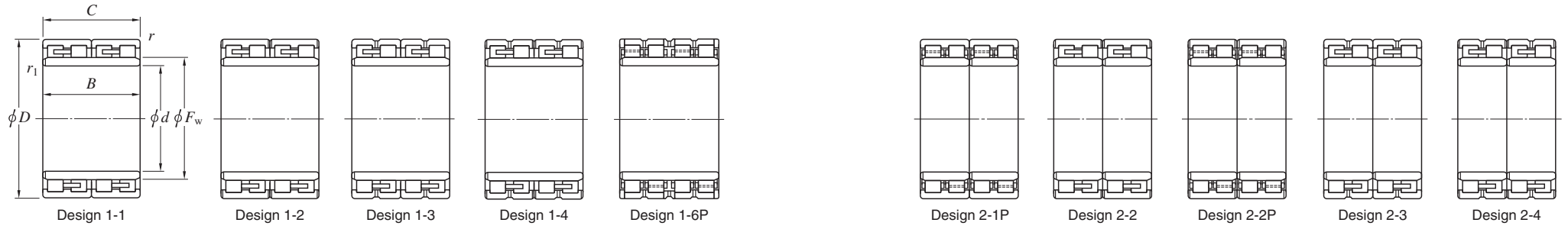

Boundary dimensions (mm)							Basic load ratings (kN)			Fatigue load limit (kN) C_u	Bearing No.	Design	Mounting dimensions (mm)					(Refer.) Mass (kg)
d	D	B	C	F_w	r min.	$r_1^{1)}$ min.	C_r	C_{0r}	d_a min.				d_a max.	$r_a^{2)}$ min.	$r_a^{2)}$ max.	$r_b^{2)}$ max.		
850	1 180	850	850	940	7.5	7.5	31 800	72 700	5 610	170FC118850 170FC118850B 4CR850A	3-2P	886	1 144	1 104	6	6	2 900	
	1 180	850	850	940	7.5	7.5	31 800	72 700	5 610			2-6P	886	1 144	1 104	6	6	2 900
	1 180	875	850	940	7.5	7.5	31 800	72 700	5 610			3-1P	886	1 144	1 104	6	6	2 930
855	1 094.9	665	655	918	6	6	22 600	58 000	4 480	171FC109655 171FC118704	2-6P	883	1 066	1 038	5	5	1 580	
	1 178	714	704	928.5	6	6	29 600	62 900	4 920			2-6P	883	1 150	1 104	5	5	2 410
860	1 140	750	750	938	7.5	7.5	26 000	63 800	4 870	172FC114750 172FC116780	2-6P	896	1 104	1 074	6	6	2 080	
	1 160	780	780	932	6	6	31 000	72 600	5 610			2-6P	888	1 132	1 088	5	5	2 470
862.98	1 219.302	876.3	889	956	7.5	7.5	37 500	84 600	6 370	173FC122889B 173FC122889	2-6P	899	1 183	1 136	6	6	3 450	
	1 219.302	889	889	960	7.5	7.5	33 100	74 400	5 680			2-6P	899	1 183	1 132	6	6	3 360
870	1 145	705	685	940	6	6	26 800	63 700	4 900	174FC115685B 174FC118750	2-6P	898	1 117	1 085	5	5	1 980	
	1 181.1	750	750	942	9.5	SP	30 800	68 600	5 250			3-2P	906	1 137	1 110	8	6	2 470
880	1 140	800	800	946	6	6	29 600	77 400	5 830	176FC114800 176FC123850A	2-6P	908	1 112	1 078	5	5	2 210	
	1 230	850	850	970	7.5	7.5	36 300	82 100	6 220			2-6P	916	1 194	1 148	6	6	3 280
900	1 220	840	840	981	7.5	7.5	35 000	83 100	6 240	180FC122840 180FC122840A 180FC123870 180FC123870A 180FC128930 180FC128840	2-6P	936	1 184	1 146	6	6	2 980	
	1 220	840	840	989	7.5	7.5	34 600	83 300	6 240			2-6P	936	1 184	1 150	6	6	2 980
	1 230	895	870	990	7.5	7.5	33 000	77 500	5 850			2-6P	936	1 194	1 154	6	6	3 170
	1 230	895	870	990	7.5	7.5	33 000	77 500	5 850			3-1P	936	1 194	1 154	6	6	3 160
	1 280	930	930	1 000	7.5	7.5	40 200	90 300	6 730			2-6P	936	1 244	1 190	6	6	4 050
	1 280	1 050	840	1 000	7.5	7.5	36 200	79 100	6 050			1-6P	936	1 244	1 190	6	6	3 890
920	1 280	815	800	1 010	7.5	7.5	36 000	79 900	6 090	184FC128800 4CR920 4CR920A	3-2P	956	1 244	1 196	6	6	3 280	
	1 280	865	850	1 015	7.5	7.5	34 600	77 500	5 890			3-1P	956	1 244	1 195	6	6	3 460
	1 300	975	950	1 019	7.5	7.5	40 800	92 600	6 840			3-2P	956	1 264	1 209	6	6	4 180
950	1 300	965	950	1 036	7.5	7.5	40 900	96 900	7 090	4CR950A 190FC133950	3-1P	986	1 264	1 216	6	6	3 900	
	1 330	950	950	1 053	9.5	9.5	41 800	97 200	7 110			2-6P	994	1 286	1 241	8	8	4 330
1 000	1 360	1 025	1 000	1 092	7.5	7.5	45 200	111 000	7 880	200FC136100		2-6P	1 036	1 324	1 276	6	6	4 480

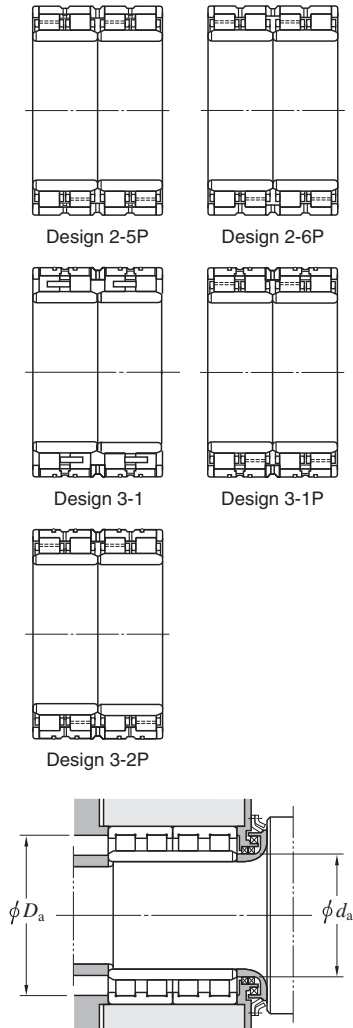

[Notes] 1) SP indicates the specially chamfered form.

2) r_a indicates housing chamfer dimension corresponding to outer ring chamfer dimension r .

r_b indicates the shaft chamfer dimension corresponding to inner ring chamfer dimension r_1 .

Four-row cylindrical roller bearings

d 1 200 ~ 1 480 mm

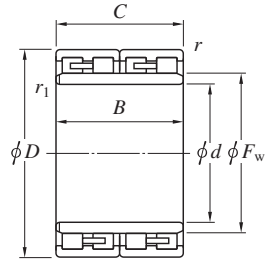

Design 1-1



Design 1-2

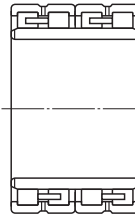

Design 1-3

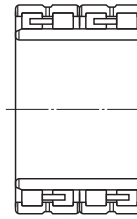

Design 1-4



Design 1-6P

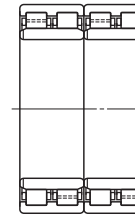

Design 2-1P

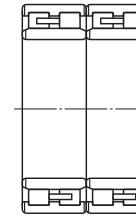

Design 2-2

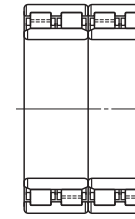

Design 2-2P

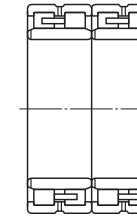

Design 2-3

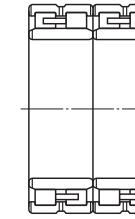

Design 2-4

Boundary dimensions (mm)							Basic load ratings (kN)		Fatigue load limit (kN) C_u	Bearing No.	Design	Mounting dimensions (mm)					(Refer.) Mass (kg)
d	D	B	C	F_w	$r_{min.}$	$r_{1min.}$	C_r	C_{0r}				d_a min.	d_a max.	r_a ¹⁾ min.	r_a ¹⁾ max.	r_b ¹⁾ max.	
1 200	1 509.85	1 027.5	1 005	1 278	7.5	7.5	45 900	131 000	8 870	240FC151101	2-6P	1 236	1 473	1 438	6	6	4 390
1 250	1 600	890	860	1 338	7.5	7.5	43 500	113 000	7 840	250FC160860A	2-6P	1 306	1 566	1 524	6	6	4 200
1 300	1 655	890	880	1 391	7.5	7.5	45 100	121 000	8 290	260FC165880	2-6P	1 336	1 619	1 571	6	6	4 830
1 349.04	1 745	1 010	1 000	1 446	7.5	7.5	55 300	146 000	9 680	270FC175110	2-6P	1 386	1 709	1 651	6	6	6 450
1 480	1 849.74	1 100	1 100	1 574	7.5	7.5	59 500	174 000	11 100	296FC185110	2-6P	1 516	1 813	1 764	6	6	7 170

[Note] 1) r_a indicates housing chamfer dimension corresponding to outer ring chamfer dimension r .
 r_b indicates the shaft chamfer dimension corresponding to inner ring chamfer dimension r_1 .

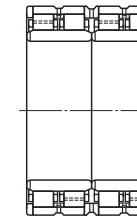

Design 2-5P

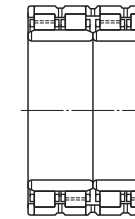

Design 2-6P

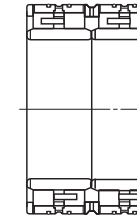

Design 3-1

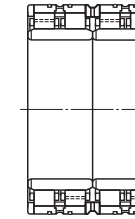

Design 3-1P

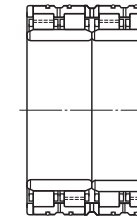

Design 3-2P

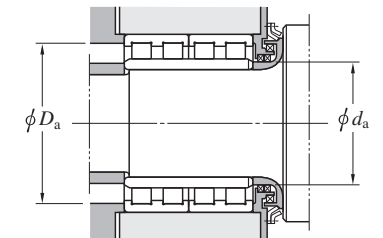

Four-row cylindrical roller bearings (tapered bore)

d 151.5 ~ 855 mm

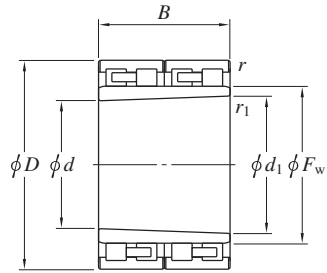

Design 1-1

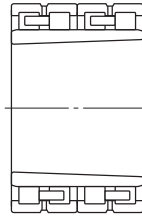

Design 1-2

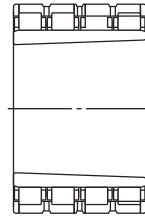

Design 1-3P

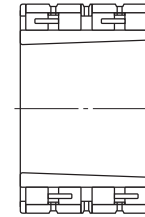

Design 1-4

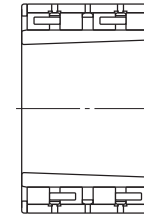

Design 2-2

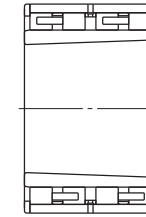

Design 2-3

Boundary dimensions (mm)							Basic load ratings (kN)			Fatigue load limit (kN) C_u	Bearing No.	Design	Mounting dimensions (mm)					Mass (kg)
d	d_1	D	B	F_w	$r_1^{1)}$ min.	r_1 min.	C_r	C_{0r}	d_a min.				D_a max.	$r_a^{2)}$ min.	$r_a^{2)}$ max.	$r_b^{2)}$ min.	$r_b^{2)}$ max.	
151.5	165.5	230	168	180	2	2	1 310	2 200	273	32FC23170AK	1-1	176	212	220	2	2	24	
181.5	195.5	260	168	209	1.1	1.1	1 400	2 530	301	314023A	1-1	203	241	253	1	1	27.7	
320.833	350	490	350	385	SP	2	5 910	11 100	1 100	70FC49350WK	1-2	360	457	480	2	2	226	
356.666	389.999	550	400	431.902	2	2	7 530	14 700	1 420	71FC55400BK	1-4	400	511	540	2	2	336	
358.83	388.83	520	360	422	5	3	5 330	10 900	1 040	467412	2-3	407.8	486	501	4	2.5	243	
412.5	450	630	450	500	4	4	8 540	16 600	1 540	90FC63450KW	1-2	468	590	612	3	3	490	
640.833	700	1 000	710	770	4	4	23 700	47 400	3 920	140FC100710K	1-3P	720	930	980	3	3	1 790	
650.833	710	1 020	710	785	4	4	24 200	49 100	4 030	142FC102710K	1-3P	730	945	1 000	3	3	2 140	
855	880	1 180	750	946	9.5	7.5	29 100	66 100	5 060	176FC118750AK	1-3P	911	1 106	1 145	8	6	2 480	

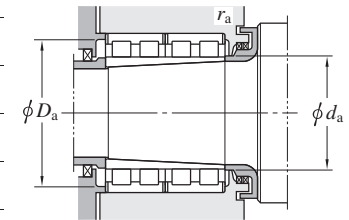

[Notes] 1) SP indicates the specially chamfered form.
 2) r_a indicates housing chamfer dimension corresponding to outer ring chamfer dimension r .
 r_b indicates the shaft chamfer dimension corresponding to inner ring chamfer dimension r_1 .

Wide series cylindrical roller bearings

■ 99, W99, SW99 series

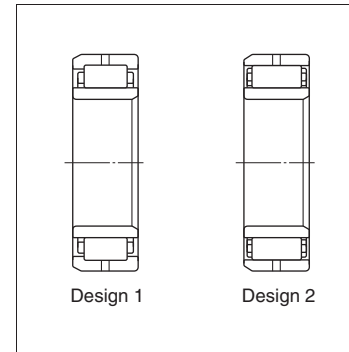

■ D99 series

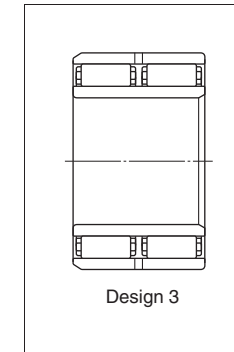

- This type has high radial load capacity, and so, is suited to heavy duty applications or where shock loading is expected.
- Outer ring is available either with or without ribs, either of which is provided with two lubrication holes. Some bearings have four lubrication holes.

■ T99 series For line shaft

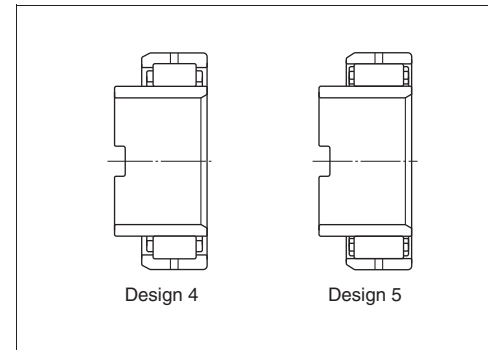

- This is a type equivalent to the above bearing except for extended inner ring provided with a key way.
- Applicable to such applications where large axial movement of the inner ring is involved, and mainly used for line shafts of rolling mill table rollers.

Tolerances	Consult with JTEKT, as bearings are manufactured at special tolerance corresponding to each application of bearing. Tolerances generally correspond to class 0 or class 6 specified in JIS B 1514 (See Table 2-2 given on page 18).
Radial internal clearance	(Refer to Table 4-4 on page 51 and 52)
Equivalent radial load	Dynamic equivalent radial load ... $P_r = F_r$ Static equivalent radial load $P_{0r} = F_r$

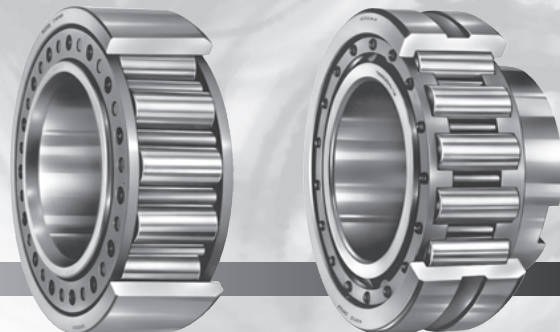

Wide series cylindrical roller bearings

d 50 ~ (150) mm

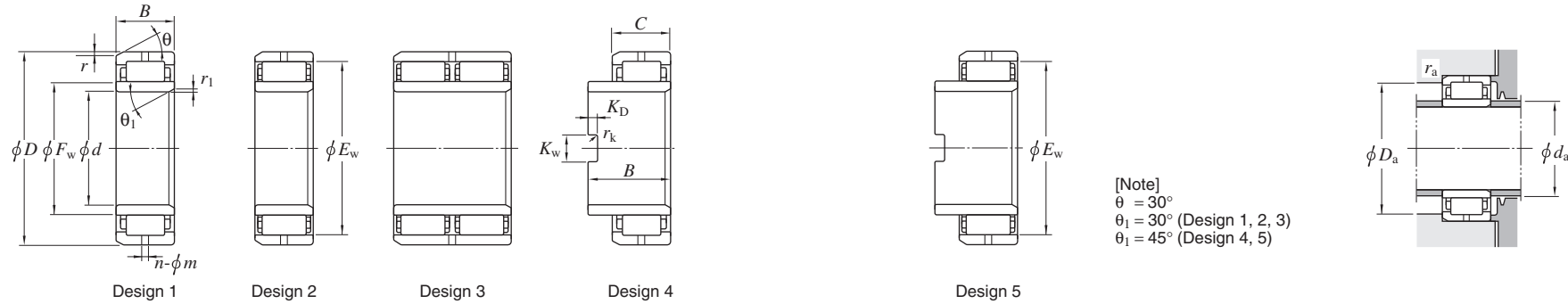

[Note]
 $\theta = 30^\circ$
 $\theta_1 = 30^\circ$ (Design 1, 2, 3)
 $\theta_1 = 45^\circ$ (Design 4, 5)

Boundary dimensions (mm)								Basic load ratings (kN)		Fatigue load limit (kN) C_u	Bearing No.	Design	Lubrication hole $n-\phi m$ (qty-mm)	Key way dimensions (mm)			Mounting dimensions (mm)			Mass (kg)
d	D	B	C	F_w	E_w	r min.	r_1 min.	C_r	C_{0r}					K_w	K_D	r_k	d_a min.	D_a max.	r_a max.	
50	90	44.450	—	60.325	—	2.0	2.0	148	167	24.2	W99210NU	1	2-8	—	—	—	58	82	1	1.17
55	100	46.025	—	66.635	89.635	2.0	2.5	183	199	29.3	W99211	2	2-8	—	—	—	64	92	1.5	1.64
60	110	49.200	—	73.025	—	2.4	2.4	216	237	34.7	W99212NU	1	2-8	—	—	—	69	101	1.5	2.02
70	125	60.325	—	84.138	109.538	2.8	2.8	303	381	55.6	W99214	2	2-9.5	—	—	—	80	115	1.5	3.19
75	130	66.675	—	88.881	114.281	2.8	2.8	328	428	61.8	W99215	2	2-9.5	—	—	—	85	120	1.5	3.69
80	140	66.675	—	95.250	—	3.2	3.2	349	437	62.1	W99216NU	1	2-11.1	—	—	—	91	129	2	4.29
100	180	58.740	—	120	—	4	4	425	483	64.8	99220NU	1	2-14	—	—	—	112	168	2.5	6.41
	180	82.550	—	120.650	—	4	4	568	701	92.9	W99220NU	1	2-14	—	—	—	112	168	2.5	9.37
101.600	180	110	58.740	120	—	4	3	425	483	64.8	T99220NU-1	4	2-14	20	10	1.5	113	167	2	7.59
110	200	65.088	—	133.500	—	R2.1	R2.1	478	579	77.1	99222NU	1	2-14	—	—	—	122	188	2	9.07
	200	88.900	—	132.500	—	4	4	664	802	103	W99222NU	1	2-14	—	—	—	123	187	2.5	11.9
114.300	200	111.125	88.900	133.350	—	4	3	663	803	103	TW99222NU	4	2-14	28.97	9.53	2	126	187	2	11.9
125.413	230	117.475	79.375	153.988	—	4.8	3	700	838	106	T99226NU	4	2-14	25.8	9.53	2	137	215	2	16.4
130	230	79.375	—	153.988	—	4.8	4	700	838	106	99226NU	1	2-14	—	—	—	143	215	2.5	13.9
	230	107.950	—	153.988	—	4.8	4	883	1 130	140	W99226NU	1	2-14	—	—	—	143	215	2.5	18.9
138.113	250	130.175	120.650	168.275	—	5.6	3	1 130	1 540	184	TXW99228NU	4	2-14	35.32	9.5	2	150	233	2	26.0
140	250	82.550	—	168.275	—	5.6	5.6	792	968	119	99228NU	1	2-14.3	—	—	—	157	233	3	17.2
	250	82.550	—	168.275	222.251	5.6	5.6	872	1 100	136	99228	2	2-14.3	—	—	—	157	233	3	17.2
	250	120.650	—	168.275	—	5.6	5.6	1 130	1 540	184	W99228NU	1	2-14	—	—	—	157	233	3	25.2
	250	120.650	—	168.275	222.251	5.6	5.6	1 260	1 770	211	W99228	2	2-14	—	—	—	157	233	3	25.2
150	270	88.900	—	179.388	—	5.6	5.6	852	1 000	121	99230NU	1	2-16	—	—	—	167	253	3	21.5
	270	120.650	—	179.388	—	5.6	5.6	1 080	1 350	160	W99230NU	1	2-16	—	—	—	167	253	3	29.6

Wide series cylindrical roller bearings

d (150) ~ 200 mm

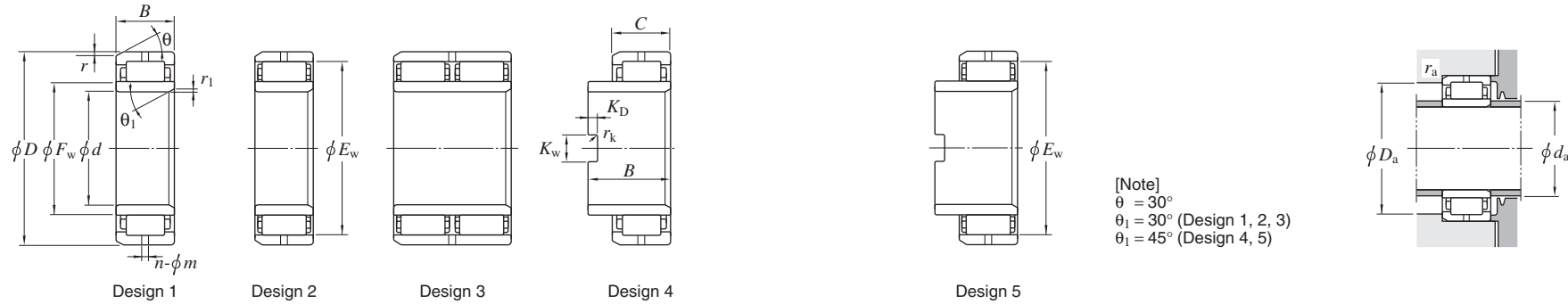

[Note]
 $\theta = 30^\circ$
 $\theta_1 = 30^\circ$ (Design 1, 2, 3)
 $\theta_1 = 45^\circ$ (Design 4, 5)

d	Boundary dimensions (mm)							Basic load ratings (kN)		Fatigue load limit (kN) C_u	Bearing No.	Design	Lubrication hole $n-\phi m$ (qty-mm)	Key way dimensions (mm)			Mounting dimensions (mm)			Mass (kg)
	D	B	C	F_w	E_w	$r_{\min.}$	$r_{1\min.}$	C_r	C_{0r}					K_w	K_D	r_k	d_a min.	D_a max.	r_a max.	
150	270	120.650	—	179.388	239.714	5.6	5.6	1 230	1 600	190	W99230	2	2-16	—	—	—	167	253	3	29.6
150.813	270	136.525	88.900	179.388	—	5.6	4.06	852	1 000	121	T99230NU	4	2-16	35.32	11.51	3	164	253	2.5	23.5
160	290	123.825	—	193.675	257.175	6.4	6.4	1 500	2 060	238	W99232	2	2-16	—	—	—	178	272	4	35.3
	290	247.650	—	193.675	257.175	6.4	6.4	2 490	3 960	459	D99232	3	2-16	—	—	—	178	272	4	70.6
163.513	290	139.700	123.825	193.675	257.175	6.4	4	1 500	2 060	238	TW99232	5	2-16	38.497	11.509	2	177	272	2.5	35.6
180	320	149.225	—	215.106	—	6.35	6.35	1 600	2 160	243	W99236NU	1	2-17.5	—	—	—	198	302	4	50.9
200	340	174.625	—	234.950	—	6.4	6.4	2 090	3 120	335	SW99240NU	1	4-17.5	—	—	—	218	322	4	64.9

Full complement cylindrical roller bearings for crane sheaves

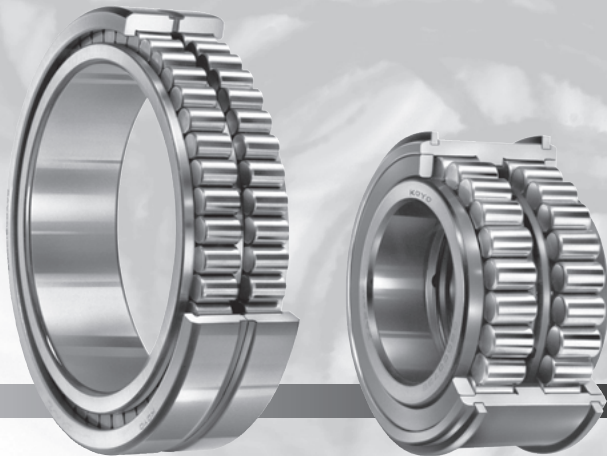

■ Double-row, open type (page 182)

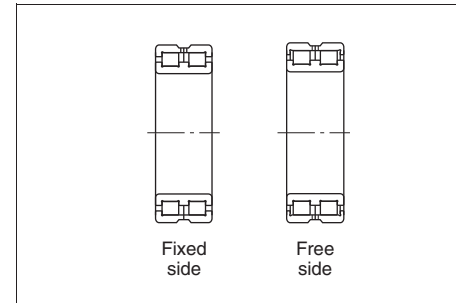

■ Double-row, shielded type (page 186)

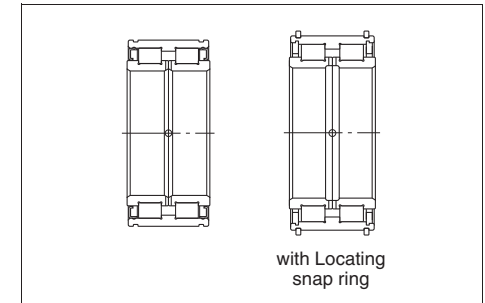

- Since full complement type cylindrical roller bearings can incorporate more rollers than bearings with cage, the load rating can be increased.
- Bearings on the fixed side is capable of withstanding radial load and axial load in both directions.
- The shielded bearing is specially designed for crane sheaves ;
 - Prelubricated with high quality grease.
 - Shield plates are located. (The rubber seal can be employed according to the operating conditions.)
 - The bearing surfaces are coated with phosphate to prevent rusting.

Boundary dimensions	As specified in JIS B 1512.																																																		
Tolerances	As specified in JIS B 1514, class 0 or 6. (refer to Table 2-2 on page 18.)																																																		
Recommended fits and radial internal clearance	<ul style="list-style-type: none"> • Recommended fits: refer to Table 3-3 on pages 39 and 40. <ul style="list-style-type: none"> ■ Fits and clearance of full complement type cylindrical roller bearings for use with crane sheaves with the rotating outer ring load 																																																		
	<table border="1"> <thead> <tr> <th colspan="2">Condition</th> <th>Shaft tolerance class</th> <th>Housing bore tolerance class</th> </tr> </thead> <tbody> <tr> <td rowspan="3">Rotating outer ring load</td> <td>Light or fluctuating load</td> <td rowspan="3">g 6 or h 6</td> <td>M 7</td> </tr> <tr> <td>Normal or heavy load</td> <td>N 7</td> </tr> <tr> <td>Heavy load on thin section housing</td> <td>P 7</td> </tr> </tbody> </table>		Condition		Shaft tolerance class	Housing bore tolerance class	Rotating outer ring load	Light or fluctuating load	g 6 or h 6	M 7	Normal or heavy load	N 7	Heavy load on thin section housing	P 7	<p>Refer to Table 4-4 on pages 51 and 52. As for the nominal bore dia. up to 140 mm shielded type (DC5000 series), the corresponding CN clearance are shown below.</p> <table border="1"> <thead> <tr> <th colspan="2">Nominal bore dia. <i>d</i> (mm)</th> <th colspan="2">CN clearance (μm)</th> </tr> <tr> <th>over</th> <th>up to</th> <th>min.</th> <th>max.</th> </tr> </thead> <tbody> <tr> <td>30</td> <td>– 40</td> <td>35</td> <td>70</td> </tr> <tr> <td>40</td> <td>– 50</td> <td>40</td> <td>75</td> </tr> <tr> <td>50</td> <td>– 65</td> <td>45</td> <td>90</td> </tr> <tr> <td>65</td> <td>– 80</td> <td>55</td> <td>105</td> </tr> <tr> <td>80</td> <td>– 100</td> <td>65</td> <td>115</td> </tr> <tr> <td>100</td> <td>– 120</td> <td>80</td> <td>120</td> </tr> <tr> <td>120</td> <td>– 140</td> <td>90</td> <td>130</td> </tr> </tbody> </table>		Nominal bore dia. <i>d</i> (mm)		CN clearance (μm)		over	up to	min.	max.	30	– 40	35	70	40	– 50	40	75	50	– 65	45	90	65	– 80	55	105	80	– 100	65	115	100	– 120	80	120	120	– 140	90
Condition		Shaft tolerance class	Housing bore tolerance class																																																
Rotating outer ring load	Light or fluctuating load	g 6 or h 6	M 7																																																
	Normal or heavy load		N 7																																																
	Heavy load on thin section housing		P 7																																																
Nominal bore dia. <i>d</i> (mm)		CN clearance (μm)																																																	
over	up to	min.	max.																																																
30	– 40	35	70																																																
40	– 50	40	75																																																
50	– 65	45	90																																																
65	– 80	55	105																																																
80	– 100	65	115																																																
100	– 120	80	120																																																
120	– 140	90	130																																																
Allowable axial load	The above fixed side bearings whose inner and outer rings have ribs can accommodate a certain magnitude of axial load. As for the equation to calculate allowable axial load in this case, refer to page 123.																																																		
Equivalent radial load	Dynamic equivalent radial load $P_r = F_r$ Static equivalent radial load $P_{0r} = F_r$																																																		

Full complement cylindrical roller bearings for crane sheaves

Double-row, open type

d 50 ~ (200) mm

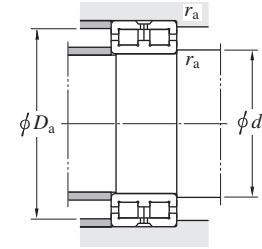
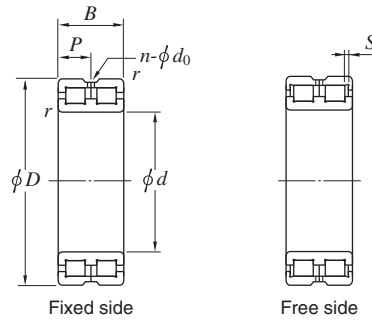

Boundary dimensions (mm)						$S^{1)}$ (mm)	Basic load ratings (kN)			Fatigue load limit (kN) C_u	Bearing No.		Lubrication holes (mm)			Mounting dimensions (mm)			Mass (kg)
d	D	B	B_1	B_2	r min.		C_r	C_{0r}			Fixed side	Free side	P	n qty	d_0	d_a min.	D_a max.	r_a max.	
50	72	22	32	42	0.6	1	61.6	82.9	14.3	DC4910AVW	DC4910VW	11	4	2	55	67	0.6	0.30	
60	85	25	37	49	1	1	91.0	136	23.4	DC4912AVW	DC4912VW	12.5	4	2	66	79	1	0.46	
70	100	30	44	57	1	1	131	193	27.0	DC4914AVW	DC4914VW	15	4	2	76	94	1	0.78	
80	110	30	44	57	1	1	141	218	30.5	DC4916AVW	DC4916VW	15	4	2	86	104	1	0.88	
90	125	35	52	68	1.1	1.5	188	301	39.3	DC4918AVW	DC4918VW	17.5	4	2.5	97	118	1	1.35	
100	140	40	59	78	1.1	2	243	400	53.3	DC4920AVW	DC4920VW	20	4	2.5	107	133	1	1.95	
110	150	40	59	78	1.1	2	252	431	56.4	DC4922AVW	DC4922VW	20	4	2.5	117	143	1	2.15	
120	165	45	66	87	1.1	3	283	479	61.3	DC4924AVW	DC4924VW	22.5	4	3	127	158	1	2.95	
130	180	50	73	96	1.5	4	345	560	66.2	DC4926AVW	DC4926VW	25	4	3	138.5	171.5	1.5	3.95	
140	190	50	73	96	1.5	4	355	589	68.7	DC4928AVW	DC4928VW	25	4	3	148.5	181.5	1.5	4.20	
150	190	40	—	—	1.1	2	293	575	69.4	DC4830AVW	DC4830VW	20	4	3	157	183	1	2.90	
	210	60	88	116	2	4	509	842	98.3	DC4930AVW	DC4930VW	30	6	4	160	200	2	6.65	
160	200	40	—	—	1.1	2	304	616	73.0	DC4832AVW	DC4832VW	20	4	3	167	193	1	3.05	
	220	60	88	116	2	4	535	895	103	DC4932AVW	DC4932VW	30	6	4	170	210	2	7.00	
170	215	45	—	—	1.1	3	337	655	77.0	DC4834AVW	DC4834VW	22.5	4	3	177	208	1	4.10	
	230	60	88	116	2	4	550	944	107	DC4934AVW	DC4934VW	30	6	4	180	220	2	7.35	
180	225	45	—	—	1.1	3	346	690	80.0	DC4836AVW	DC4836VW	22.5	4	4	187	218	1	4.30	
	250	69	101	133	2	4	686	1 140	140	DC4936AVW	DC4936VW	34.5	6	4	190	240	2	10.7	
190	240	50	—	—	1.5	4	411	782	84.3	DC4838AVW	DC4838VW	25	4	4	198.5	231.5	1.5	5.65	
	260	69	101	133	2	4	694	1 200	145	DC4938AVW	DC4938VW	34.5	6	5	200	250	2	11.2	
200	250	50	—	—	1.5	4	423	826	87.8	DC4840AVW	DC4840VW	25	4	4	208.5	241.5	1.5	5.90	

[Note] 1) Effective movement of the bearing on the free side in an axial direction.

Full complement cylindrical roller bearings for crane sheaves

Double-row, open type

d (200) ~ 400 mm

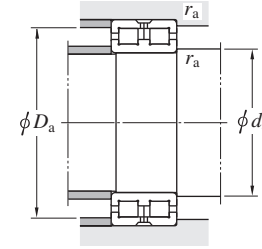
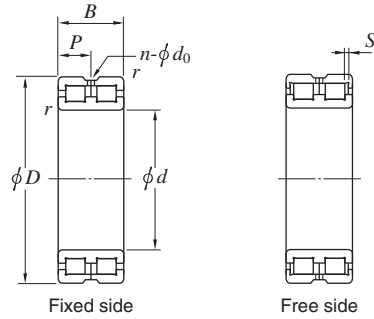

Boundary dimensions (mm)						$S^{1)}$ (mm)	Basic load ratings (kN)			Fatigue load limit (kN) C_u	Bearing No.		Lubrication holes (mm)			Mounting dimensions (mm)			Mass (kg)
d	D	B	B_1	B_2	$r_{min.}$		C_r	C_{0r}			Fixed side	Free side	P	n qty	d_0	d_a min.	D_a max.	r_a max.	
200	280	80	116	152	2.1	5	834	1 500	182	DC4940AVW	DC4940VW	40	6	6	212	268	2	15.7	
	300	80	116	152	2.1	5	884	1 600	190	DC4944AVW	DC4944VW	40	6	6	232	288	2	17.1	
240	300	60	—	—	2	4	639	1 330	139	DC4848AVW	DC4848VW	30	6	5	250	290	2	10.2	
	320	80	116	152	2.1	5	918	1 720	201	DC4948AVW	DC4948VW	40	6	6	252	308	2	18.4	
260	320	60	—	—	2	4	667	1 450	148	DC4852AVW	DC4852VW	30	6	5	270	310	2	11.0	
	360	100	146	192	2.1	6	1 340	2 520	275	DC4952AVW	DC4952VW	50	8	6	272	348	2	32.0	
280	350	69	—	—	2	4	832	1 720	189	DC4856AVW	DC4856VW	34.5	6	5	290	340	2	16.0	
	380	100	146	192	2.1	6	1 410	2 700	290	DC4956AVW	DC4956VW	50	8	6	292	368	2	33.9	
300	380	80	—	—	2.1	6	1 010	2 160	237	DC4860AVW	DC4860VW	40	8	6	312	368	2	23.0	
	420	118	174	230	3	6	1 950	3 710	399	DC4960AVW	DC4960VW	59	8	8	314	406	2.5	53.0	
320	400	80	—	—	2.1	6	1 040	2 310	249	DC4864AVW	DC4864VW	40	8	6	332	388	2	24.3	
340	420	80	—	—	2.1	6	1 070	2 430	258	DC4868AVW	DC4868VW	40	8	6	352	408	2	25.6	
	460	118	174	230	3	6	2 080	4 150	432	DC4968AVW	DC4968VW	59	8	8	354	446	2.5	59.0	
360	440	80	—	—	2.1	6	1 100	2 580	270	DC4872AVW	DC4872VW	40	8	6	372	428	2	27.0	
	480	118	174	230	3	6	2 120	4 390	450	DC4972AVW	DC4972VW	59	8	8	374	466	2.5	62.0	
380	480	100	—	—	2.1	6	1 650	3 570	355	DC4876AVW	DC4876VW	50	8	6	392	468	2	45.3	
	520	140	206	272	4	7	2 870	5 600	553	DC4976AVW	DC4976VW	70	8	8	398	502	3	92.3	
400	540	140	206	272	4	7	2 980	5 990	582	DC4980AVW	DC4980VW	70	8	8	418	522	3	96.4	

[Note] 1) Effective movement of the bearing on the free side in an axial direction.

Double-row, shielded type

d 40 ~ 150 mm

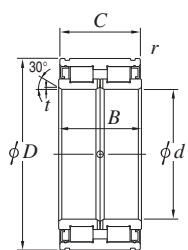

Design 1

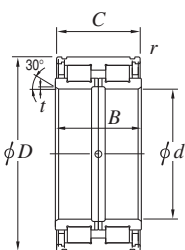

Design 2

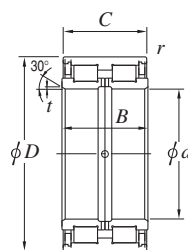

Design 3

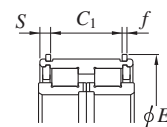

With locating snap rings

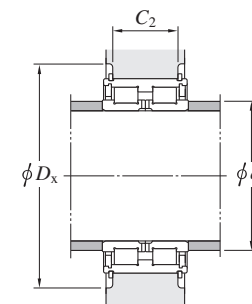

Boundary dimensions (mm)						Basic load ratings (kN)		Fatigue load limit (kN) Cu	Bearing No.		De-sign	Locating snap ring specifications (mm)				Mounting dimensions (mm)			(Refer.) Mass (kg)
d	D	B	C	t	r min.	Cr	C0r		Without locating snap rings	With locating snap rings		C1 ¹⁾	S	E	f	da min.	Ds min.	C2 ²⁾	
40	68	38	37	0.9	0.6	110	125	15.9	DC5008N	DC5008NR	1	28	4.5	71.8	2	46	80	28	0.55
45	75	40	39	0.9	0.6	119	144	18.5	DC5009N	DC5009NR	1	30	4.5	78.8	2	51	87	30	0.70
50	80	40	39	0.9	0.6	125	158	20.2	DC5010N	DC5010NR	1	30	4.5	83.8	2	56	92	30	0.75
55	90	46	45	1.2	0.6	148	193	25.6	DC5011N	DC5011NR	1	34	5.5	94.8	2.5	63	104	34	1.19
60	95	46	45	1.2	0.6	154	208	27.7	DC5012N	DC5012NR	1	34	5.5	99.8	2.5	68	109	34	1.27
65	100	46	45	1.2	0.6	160	224	29.7	DC5013N	DC5013NR	1	34	5.5	104.8	2.5	73	114	34	1.30
70	110	54	53	1.2	0.6	214	284	40.4	DC5014N	DC5014NR	1	42	5.5	114.5	2.5	78	124	42	1.94
75	115	54	53	1.2	0.6	223	309	43.7	DC5015N	DC5015NR	1	42	5.5	119.5	2.5	83	129	42	2.11
80	125	60	59	1.2	0.6	314	427	56.3	DC5016N	DC5016NR	1	48	5.5	129.5	2.5	88	146	48	2.65
85	130	60	59	1.2	0.6	321	446	58.1	DC5017N	DC5017NR	1	48	5.5	134.5	2.5	93	155	48	2.80
90	140	67	66	1.4	0.6	381	539	71.4	DC5018N	DC5018NR	1	54	6	145.4	2.5	100	165	54	3.70
95	145	67	66	1.4	0.6	390	564	73.5	DC5019N	DC5019NR	1	54	6	150.4	2.5	105	175	54	3.90
100	150	67	66	1.4	0.6	398	583	75.6	DC5020N	DC5020NR	1	54	6	155.4	2.5	110	180	54	4.05
110	170	80	79	1.7	1	480	696	97.4	DC5022N	DC5022NR	1	65	7	175.4	2.5	122	200	65	6.50
120	180	80	79	1.7	1	500	750	103	DC5024N	DC5024NR	1	65	7	188.4	3	132	210	65	6.95
130	200	95	94	1.7	1	671	1 000	135	DC5026N	DC5026NR	1	77	8.5	208.4	3	142	230	77	10.5
140	210	95	94	1.7	1	678	1 070	142	DC5028N	DC5028NR	1	77	8.5	218.4	3	152	245	77	11.0
150	225	100	99	2	1	857	1 400	177	DC5030N	DC5030NR	2	81	9	233	3	178.5	244	81	13.9

[Notes] 1) Dimensional tolerance of C₁ is +0.4/0 when bore diameter is not more than 170 mm, while +0.6/0 when bore diameter is over 170 mm.

2) Dimensional tolerance of C₂ is -0.1/-0.5 when bore diameter is not more than 170 mm, while -0.1/-0.7 when bore diameter is over 170 mm.

Full complement cylindrical roller bearings for crane sheaves

Double-row, shielded type

d 160 ~ 380 mm

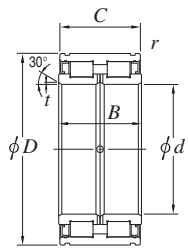

Design 1

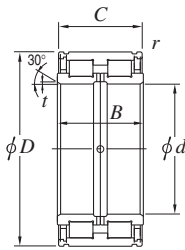

Design 2

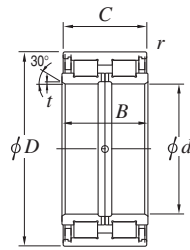

Design 3

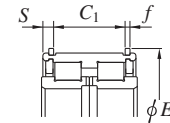

With locating snap rings

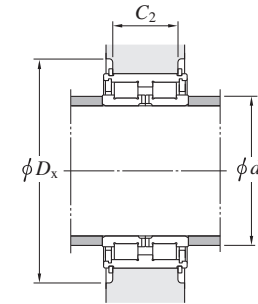

d	Boundary dimensions (mm)					Basic load ratings (kN)		Fatigue load limit (kN) Cu	Bearing No.		De-sign	Locating snap ring specifications (mm)				Mounting dimensions (mm)			(Refer.) Mass (kg)
	D	B	C	t	r min.	Cr	Cor		Without locating snap rings	With locating snap rings		C1 ¹⁾	S	E	f	da min.	Ds min.	C2 ²⁾	
160	240	109	108	2	1.1	987	1 640	205	DC5032N	DC5032NR	2	89	9.5	248	3	190	259	89	17.2
170	260	122	121	2	1.1	1 230	2 020	243	DC5034N	DC5034NR	2	99	11	270	4	204	286	99	23.1
180	280	136	135	2	1.1	1 450	2 440	292	DC5036N	DC5036NR	2	110	12.5	290	4	217.5	306	110	30.8
190	290	136	135	2	1.1	1 480	2 530	300	DC5038N	DC5038NR	2	110	12.5	300	4	225	316	110	32.4
200	310	150	149	2	1.1	1 750	2 980	341	DC5040N	DC5040NR	2	120	14.5	320	4	240	336	120	41.7
220	340	160	159	2.5	1.1	2 040	3 590	396	DC5044N	DC5044NR	2	130	14.5	356	6	266.5	380	130	53.5
240	360	160	159	2.5	1.1	2 120	3 850	417	DC5048N	DC5048NR	2	130	14.5	376	6	284.5	400	130	57.3
260	400	190	189	3	1.5	2 810	4 980	528	DC5052N	DC5052NR	2	154	17.5	416	7	312.5	444	154	87.2
280	420	190	189	3	1.5	2 920	5 350	557	DC5056N	DC5056NR	2	154	17.5	436	7	334.5	464	154	93.0
300	460	218	216	3	1.5	3 590	6 610	672	DC5060	—	3	—	—	—	—	361	—	—	134
320	480	218	216	3	1.5	3 710	6 930	696	DC5064	—	3	—	—	—	—	378.5	—	—	140
340	520	243	241	3.5	2	4 510	8 420	828	DC5068	—	3	—	—	—	—	413	—	—	189
380	560	243	241	3.5	2	4 790	9 020	887	DC5076	—	3	—	—	—	—	441	—	—	207

[Notes] 1) Dimensional tolerance of C₁ is +0.4/0 when bore diameter is not more than 170 mm, while +0.6/0 when bore diameter is over 170 mm.

2) Dimensional tolerance of C₂ is -0.1/-0.5 when bore diameter is not more than 170 mm, while -0.1/-0.7 when bore diameter is over 170 mm.

Tapered roller bearings

■ Single-row (page 196)

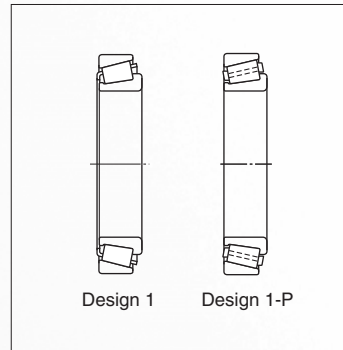

- Able to carry radial and axial load in one direction simultaneously. Combined radial and axial load can be also accommodated. Suitable for heavy load and impact load.
- The larger the contact angle (α), the greater the bearing resistance to axial load. {Steep angle type ... $\alpha \geq 25^\circ$ (constant $e \geq 0.67$)}
- Koyo tapered roller bearings whose bearing numbers are suffixed by "J" are precision ground in accordance with the ISO 355 (Sub-unit, Metric Series) specifying the outer ring width and small inside diameter as well as the contact angle, so that outer rings and inner ring assembly (inner ring, rollers and cage assembly) of these bearings are internationally interchangeable.

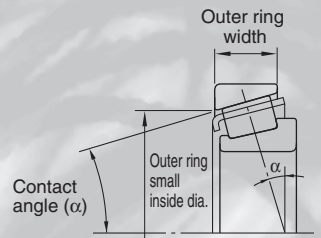

ISO sub-unit specifications

[Note] When supplementary code "J" is added as a prefix (not a suffix) to bearing numbers (e.g. JHM720249/JHM720210), the bearings are not designed according to ISO 355. Such bearings are called "J series metric tapered roller bearings," and are produced according to special tolerances.

■ Double-row (Face to face)

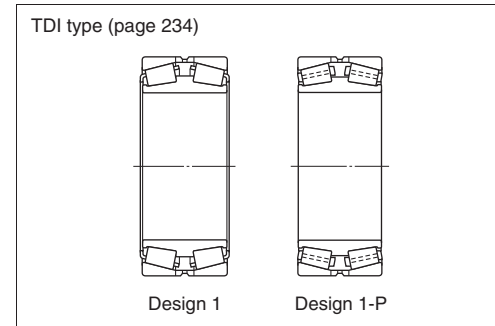

- The TDI type bearing is made up of two single-row outer rings and one double inner ring, and is generally provided with an outer ring spacer. The bearing with outer ring spacer is handy for mounting, as its end play has been pre-adjusted for each application.
- The spacer is provided with a lubrication groove and several lubrication holes.
- Used for roll neck of medium-duty rolling mills, speed reducers, etc.

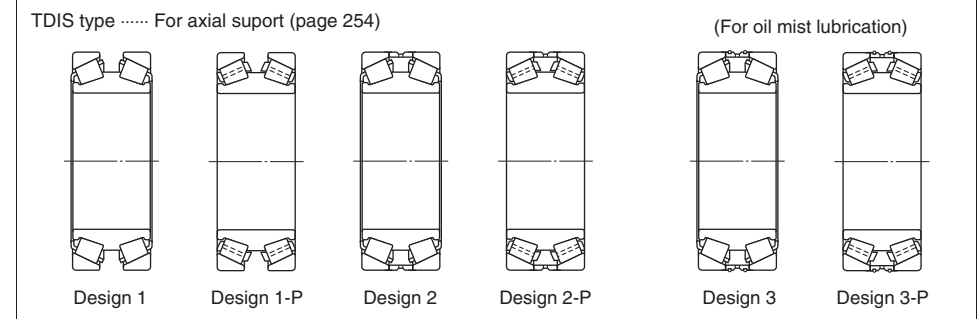

- The TDIS type bearing is of the same construction as the TDI type, except that it has a larger contact angle so that it can accommodate heavier axial load.
- Used for applications where the axial load is greater than the radial load or where only the axial load is applied. The bearing with the key way on the inner ring is mainly used for rolling mill roll necks. The bearing may be also used with preload without using the outer ring spacer.
- The bearing having lubrication holes and O-rings on its outer ring is used for oil mist lubrication.

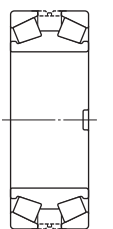

(Example of key way)

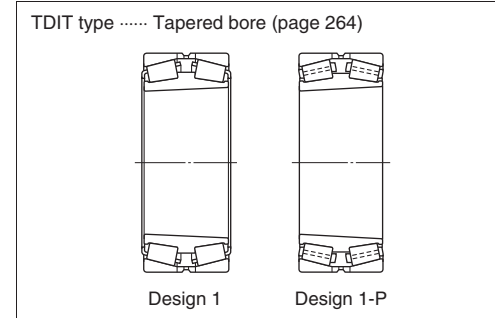

- Where the interference fit is necessary, and needs to be removed frequently, the use of TDIT type is convenient. It is also possible to mount the bearing on the shaft by using an adaptor sleeve.
- Used for roll neck of light or medium-duty rolling mills and roll neck of calendar mills.
- The use of a hydraulic unit will facilitate bearing mounting/dismounting.
- The roll neck taper needs to be matched to the bore diameter of bearing by using taper gauge, sign bar gauge, etc.

■ Double-row (Back to back)

TDO, TDOS type (page 268)

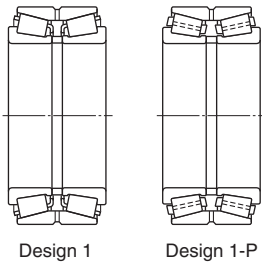

Design 1

Design 1-P

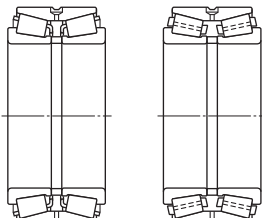

Design 2

Design 2-P

TNA type (page 314)

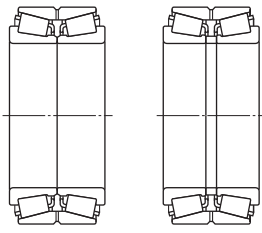

Design 1

Design 2
(with inner ring spacer)

- The TDO type bearing is made up of one double outer ring, two single-row inner rings and one inner ring spacer. The outer ring is provided with several lubrication holes.
- The inner ring spacer has been adjusted to provide an end play suitable to each application. It is also possible to freely adjust the end play for use by removing the inner ring spacer, however, it requires time and labor.
- Suitable to case where moment may act. Used for speed reducer, winding machine, etc.
- The steep angle type (TDOS type) having large contact angle has increased axial load capacity, and is widely used for worm shaft of medium, heavy duty applications, thrust bearing of reducers etc.

- The TNA type bearing has different assembled width tolerance from the TDO type, specially selected for the TNA type.

[Reference] Features of bearing with pin type cage

(1) Load rating can be increased.

The pin type cage accommodates a larger number of rollers, thus making it possible to increase the load rating of bearing.

(2) Reduced friction resistance

Friction coefficient of pin type cage is reduced, as contact area of roller and cage is limited.

(3) Easy mounting/dismounting

The pin type cage is provided with a tap hole for lifting.

The use of tap hole will facilitate the work.

Use ISO metric thread for lifting tap screw.

■ Four-row

TQO type (page 318)

(For oil mist lubrication)

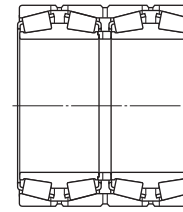

Design 1

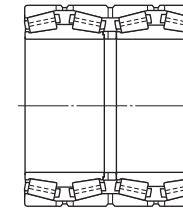

Design 1-P

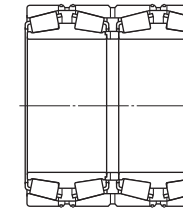

Design 2

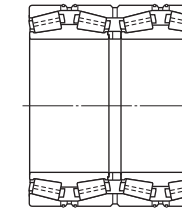

Design 2-P

45D type (page 352)

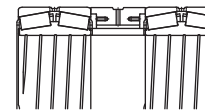

Design 1

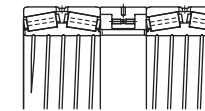

Design 1-P

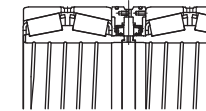

Design 2

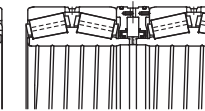

Design 2-P

Sealed type (page 356)

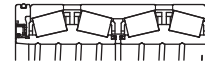

Design 1

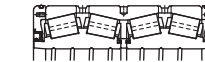

Design 1-P



Design 2

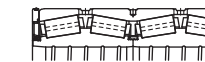

Design 2-P

- The four-row tapered roller bearing with cylindrical bore is designed to maximize the load capacity with minimum space, and is widely used for roll neck of lower, medium speed rolling mills.
- The bearing of this type is made up of one double outer ring, two single-row outer rings, two double inner rings and inner ring spacer/ outer ring spacer. Since each component is not interchangeable, it is necessary to assemble each component as specified with care taken to the matching marks marked on the bearing.
- Since the internal clearance has been pre-adjusted, the bearing can be used with ease without any necessity of readjustment.
- Since the bearing needs to be removed frequently and is clearance-fitted to the roll neck, the inner ring spacer is hardened to avoid wear. The lubrication grooves are provided on both sides of the inner ring spacer to allow the lubricant to be readily passed to the roll neck.

The lubrication groove and lubrication holes are provided at the outside diameter of double outer ring and outer ring spacer.

- The bearing provided with lubrication holes and O-rings on the outer ring is used for oil mist lubrication.
- Sealed type four-row tapered roller bearings have oil seals on their side faces and in between inner rings, and O-rings on their outside surfaces to achieve the purposes below.
 - Reduction in frequency of disassembly, washing, and reassembly
 - Improvement in working environment of disassembly, washing, and reassembly
 - Reduction in grease consumption
 - Improvement in ambient surrounding rolling mills
- Design 2 shows the compact oil seal type to increase the load rating of a four-row tapered roller bearing. The intermediate seal in the Design 2 has advantages below.
 - Compact
 - Easy disassembly, washing, and reassembly

[Applicable tolerance for tapered roller bearings]

Type of tapered roller bearings		Applicable tolerance*
Single-row	Metric series	32900JR, 32000JR, 33000JR, 33100JR, 30200JR, 32200JR, 33200JR, 30300JR, 31300JR, 32300JR
	Inch series	(56418/56650, HM125943/HM125910 etc.)
	Metric J series	(JHM720249/JHM720210 etc.)
Double-row Four-row	Metric series	45200, 45300, 46200(A), 46300(A), 46T30200JR, 46T32200JR, 46T30300JR, 46T32300JR, 37200, 47200, 47300
	Inch series	(LM377449D/LM377410, 67388/67322D) (EE127094D/127138/127139D etc.)
	The others	45T..., 46T..., 47T..., 2TR..., 4TR...

* Consult with JTEKT if a higher tolerance class than that shown in this table is necessary.

Allowable misalignment	Single-row tapered roller bearings : 0.000 9 rad (3') (If the misalignment exceeds this angle size, JTEKT is ready to design special bearings to order.)	
Radial internal clearance	(refer to Table 4-5 on page 53) Radial internal clearance of double-row and four-row tapered roller bearings	
Standard cage	Pressed cage or pin type cage	
Equivalent radial load	Single-row	Dynamic equivalent radial load $\left(\text{when } \frac{F_a}{F_r} \leq e \right) P_r = F_r$ $\left(\text{when } \frac{F_a}{F_r} > e \right) P_r = 0.4F_r + Y_1F_a$
		Static equivalent radial load $P_{0r} = 0.5F_r + Y_0F_a$ when $P_{0r} < F_r$, $P_{0r} = F_r$
	Double-row four-row	Dynamic equivalent radial load $\left(\text{when } \frac{F_a}{F_r} \leq e \right) P_r = F_r + Y_2F_a$ $\left(\text{when } \frac{F_a}{F_r} > e \right) P_r = 0.67F_r + Y_3F_a$
		Static equivalent radial load $P_{0r} = F_r + Y_0F_a$

[Note]
Refer to the bearing specification table for the values of axial load factors Y_1, Y_2, Y_3 and Y_0 and constant e .

Dynamic equivalent load calculation : when a pair of single-row tapered roller bearings is arranged face-to-face or back-to-back.

While radial loads F_{rA} and F_{rB} are applied to bearings A and B, axial load K_a externally acts in the directions shown in the figures below.

[Remark]
When radial load is applied to a single-row tapered roller bearing, axial load generated as an axial component of force acts on another bearing. The axial load can be obtained by the following equation.

$$F_a = \frac{F_r}{2Y_1}$$

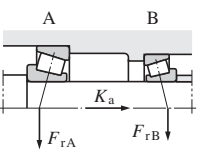
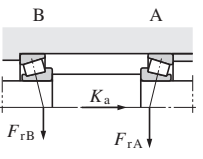
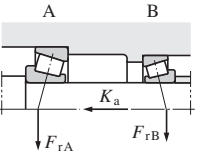
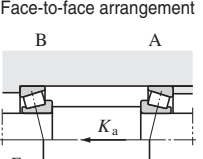
Paired mounting	Loading condition	Bearing	Axial load	Dynamic equivalent load
Back-to-back arrangement 	$\frac{F_{rB}}{2Y_B} + K_a \geq \frac{F_{rA}}{2Y_A}$	Bearing A	$\frac{F_{rB}}{2Y_B} + K_a$	$P_A = XF_{rA} + Y_A \left(\frac{F_{rB}}{2Y_B} + K_a \right)$ $P_A = F_{rA}$, where $P_A < F_{rA}$
		Bearing B	-	$P_B = F_{rB}$
Face-to-face arrangement 	$\frac{F_{rB}}{2Y_B} + K_a < \frac{F_{rA}}{2Y_A}$	Bearing A	-	$P_A = F_{rA}$
		Bearing B	$\frac{F_{rA}}{2Y_A} - K_a$	$P_B = XF_{rB} + Y_B \left(\frac{F_{rA}}{2Y_A} - K_a \right)$ $P_B = F_{rB}$, where $P_B < F_{rB}$
Back-to-back arrangement 	$\frac{F_{rB}}{2Y_B} \leq \frac{F_{rA}}{2Y_A} + K_a$	Bearing A	-	$P_A = F_{rA}$
		Bearing B	$\frac{F_{rA}}{2Y_A} + K_a$	$P_B = XF_{rB} + Y_B \left(\frac{F_{rA}}{2Y_A} + K_a \right)$ $P_B = F_{rB}$, where $P_B < F_{rB}$
Face-to-face arrangement 	$\frac{F_{rB}}{2Y_B} > \frac{F_{rA}}{2Y_A} + K_a$	Bearing A	$\frac{F_{rB}}{2Y_B} - K_a$	$P_A = XF_{rA} + Y_A \left(\frac{F_{rB}}{2Y_B} - K_a \right)$ $P_A = F_{rA}$, where $P_A < F_{rA}$
		Bearing B	-	$P_B = F_{rB}$

[Remarks] 1. These equations can be used when internal clearance and preload during operation are zero.
2. Radial load is treated as positive in the calculation, if it is applied in a direction opposite that shown in Fig. above table.

Single-row tapered roller bearings

d 100 ~ (105) mm

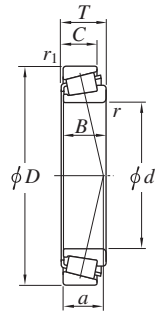

Design 1



Design 1-P

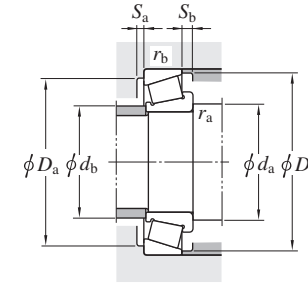

Boundary dimensions										Bearing No. ¹⁾	De- sign	Basic load ratings (kN)		Fatigue load limit (kN) <i>C_u</i>	Load center (mm) <i>a</i>	Mounting dimensions (mm)								Con- stant <i>e</i>	Axial load factors <i>Y₁</i> <i>Y₀</i>		(Refer.) Mass (kg)			
<i>d</i> mm	<i>D</i> mm	<i>T</i> mm	<i>B</i> mm	<i>C</i> mm	<i>r</i> min.	<i>r₁</i> min.	<i>C_r</i>	<i>C_{0r}</i>	<i>d_a</i> min.			<i>d_b</i> max.	<i>D_a</i> max.			<i>D_b</i> min.	<i>S_a</i> min.	<i>S_b</i> min.	<i>r_a</i> max.	<i>r_b</i> max.	<i>Y₁</i>	<i>Y₀</i>								
100	—	140	—	25	—	25	—	20	—	1.5	1.5	32920JR	1	158	217	32.0	24.0	109	108	131	128	135	5	5	1.5	1.5	0.33	1.82	1.00	1.19
	—	150	—	32	—	32	—	24	—	2	1.5	32020JR	1	233	298	43.8	32.6	110	109	141	134	144	6	8	2	1.5	0.46	1.31	0.72	1.95
	—	150	—	39	—	39	—	32.5	—	2	1.5	33020JR	1	290	397	59.0	28.6	110	108	141	135	143	7	6.5	2	1.5	0.29	2.09	1.15	2.40
100.000	3.9370	155.000	6.1024	36.000	1.4173	35.000	1.3780	28.000	1.1024	3.0	2.5	JM720249/JM720210	1	86.5	328	12.1	35.6	110	110	146	139	148	5.9	8	3.0	2.5	0.47	1.27	0.70	2.40
	3.9370	160.000	6.2992	41.000	1.6142	40.000	1.5748	32.000	1.2598	3.0	2.5	JHM720249/JHM720210	1	298	378	54.6	38.3	110	111	151	143	153	6.4	9	3.0	2.5	0.47	1.28	0.70	3.08
100	—	165	—	52	—	52	—	40	—	2.5	2	33120JR	1	408	523	67.4	40.1	112	111	155	142	159	8	12	2	2	0.41	1.48	0.81	4.29
	—	180	—	37	—	34	—	29	—	3	2.5	30220JR	1	323	338	49.1	36.8	114	116	168	157	168	5	8	2.5	2	0.42	1.43	0.79	3.83
	—	180	—	49	—	46	—	39	—	3	2.5	32220JR	1	435	495	63.9	42.1	114	114	168	154	171	5	10	2.5	2	0.42	1.43	0.79	5.21
	—	180	—	63	—	63	—	48	—	3	2.5	33220JR	1	540	680	85.8	45.7	114	112	168	151	172	10	15	2.5	2	0.40	1.48	0.82	6.92
100.000	3.9370	200.000	7.8740	52.761	2.0772	49.213	1.9375	34.925	1.3750	3.6	3.2	98394X/98788	1	433	471	58.8	54.7	112	123	189	170	185	4.8	17.8	3.6	3.2	0.63	0.95	0.52	6.91
100	—	215	—	56.5	—	51	—	35	—	4	3	31320JR	1	465	459	56.4	67.7	118	120	201	183	202	6	17.5	3	2.5	0.83	0.73	0.40	8.72
100.012	3.9375	157.162	6.1875	36.512	1.4375	36.116	1.4219	26.195	1.0313	3.6	3.2	52393/52618	1	227	288	41.7	36.0	113	115	145	142	150	5	10.3	3.6	3.2	0.47	1.26	0.69	2.43
101.600	4.0000	146.050	5.7500	21.433	0.8438	21.433	0.8438	16.670	0.6563	1.6	1.6	L521945R/L521910	1	108	167	23.5	26.2	110	119	137	134	138	4	4.8	1.6	1.6	0.39	1.53	0.84	1.17
	4.0000	157.162	6.1875	36.512	1.4375	36.116	1.4219	26.195	1.0313	3.6	3.2	52400/52618	1	227	288	41.7	36.0	114	115	145	142	150	5	10.3	3.6	3.2	0.47	1.26	0.69	2.36
	4.0000	161.925	6.3750	36.513	1.4375	36.116	1.4219	26.195	1.0313	3.6	3.2	52400/52637	1	227	288	41.7	36.0	114	115	150	142	150	5	10.3	3.6	3.2	0.47	1.26	0.69	2.60
	4.0000	168.275	6.6250	41.275	1.6250	41.275	1.6250	30.162	1.1875	3.6	3.2	687/672	1	282	349	50.4	38.6	114	115	156	146	156	4.7	11.1	3.6	3.2	0.47	1.28	0.70	3.37
	4.0000	180.975	7.1250	47.625	1.8750	48.006	1.8900	38.100	1.5000	3.6	3.2	780/772	1	362	438	56.6	39.5	114	120	169	156	165	4.2	9.5	3.6	3.2	0.39	1.56	0.86	5.01
	4.0000	190.500	7.5000	57.150	2.2500	57.531	2.2650	46.038	1.8125	7.9	3.2	HH221449/HH221410	1	549	602	76.9	42.5	123	119	179	168	178	5.9	11.1	7.9	3.2	0.33	1.79	0.99	6.93
	4.0000	200.000	7.8740	52.761	2.0772	49.212	1.9375	34.925	1.3750	3.6	3.2	98400/98788	1	433	471	58.8	54.5	114	123	188	170	185	4.8	17.8	3.6	3.2	0.63	0.95	0.52	6.83
	4.0000	212.725	8.3750	66.675	2.6250	66.675	2.6250	53.975	2.1250	7.1	3.2	941/932	1	563	674	84.1	47.6	121	135	201	181	192	4	12.7	7.1	3.2	0.33	1.84	1.01	11.1
4.0000	212.725	8.3750	66.675	2.6250	66.675	2.6250	53.975	2.1250	7.1	3.2	HH224335/HH224310	1	641	699	87.1	47.6	121	134	201	189	201	7	12.7	7.1	3.2	0.33	1.84	1.01	10.8	
104.775	4.1250	180.975	7.1250	47.625	1.8750	48.006	1.8900	38.100	1.5000	3.6	3.2	782/772	1	362	438	56.6	39.5	117	120	169	156	165	4.2	9.5	3.6	3.2	0.39	1.56	0.86	4.82
	4.1250	180.975	7.1250	47.625	1.8750	48.006	1.8900	38.100	1.5000	6.4	3.2	786/772	1	362	438	56.6	39.5	123	120	169	156	165	4.2	9.5	6.4	3.2	0.39	1.56	0.86	4.80
	4.1250	190.500	7.5000	47.625	1.8750	49.212	1.9375	34.925	1.3750	3.6	3.2	71412/71750	1	381	483	60.9	40.9	117	131	179	167	177	6.4	12.7	3.6	3.2	0.42	1.44	0.79	5.68
105	—	145	—	25	—	25	—	20	—	1.5	1.5	32921JR	1	160	224	32.6	25.1	114	113	136	133	140	5	5	1.5	1.5	0.34	1.75	0.96	1.23

[Note] 1) While metric series bearings have minus tolerances for bore and OD, inch series have plus tolerances. Refer to page 194 for details of applicable tolerance standards.

Single-row tapered roller bearings

d (105) ~ (114.300) mm

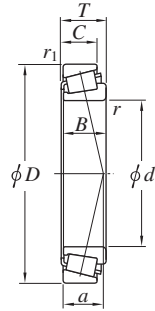

Design 1



Design 1-P

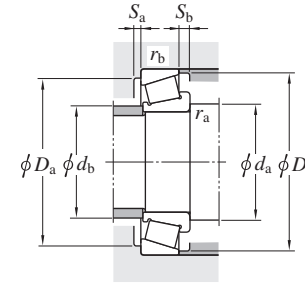

Boundary dimensions										Bearing No. ¹⁾	De- sign	Basic load ratings (kN)		Fatigue load limit (kN) C_u	Load center (mm) a	Mounting dimensions (mm)								Con- stant e	Axial load factors Y_1 Y_0		(Refer.) Mass (kg)			
d mm	D mm	T mm	B mm	C mm	r min.	r_1 min.	C_r	C_{Or}	d_a min.			d_b max.	D_a max.			D_b min.	S_a min.	S_b min.	r_a max.	r_b max.	e	Y_1	Y_0							
105	—	160	—	35	—	35	—	26	—	2.5	2	32021JR	1	270	344	49.9	34.5	117	116	150	143	154	6	9	2	2	0.44	1.35	0.74	2.45
	—	160	—	43	—	43	—	34	—	2.5	2	33021JR	1	335	461	67.4	30.9	117	116	150	145	153	7	9	2	2	0.28	2.12	1.17	3.08
	—	190	—	39	—	36	—	30	—	3	2.5	30221JR	1	360	380	52.3	39.0	119	122	178	165	178	6	9	2.5	2	0.42	1.43	0.79	4.49
	—	190	—	53	—	50	—	43	—	3	2.5	32221JR	1	490	567	73.0	44.8	119	120	178	161	180	6	10	2.5	2	0.42	1.43	0.79	6.37
	—	225	—	58	—	53	—	36	—	4	3	31321JR	1	495	489	59.4	70.3	123	126	211	193	211	6	18	3	2.5	0.83	0.73	0.40	9.72
106.362	4.1875	165.100	6.5000	36.513	1.4375	36.513	1.4375	26.988	1.0625	3.6	3.2	56418/56650	1	231	300	42.9	38.5	119	120	153	148	157	5.5	9.5	3.6	3.2	0.50	1.21	0.66	2.65
107.950	4.2500	158.750	6.2500	23.020	0.9063	21.438	0.8440	15.875	0.6250	3.6	3.2	37425/37625	1	130	169	23.9	36.5	121	121	147	141	148	4.3	7.1	3.6	3.2	0.61	0.99	0.54	1.38
	4.2500	161.925	6.3750	34.925	1.3750	34.925	1.3750	26.988	1.0625	3.6	3.2	48190/48120	1	216	293	41.8	39.1	121	120	150	145	154	4.2	7.9	3.6	3.2	0.51	1.19	0.65	2.39
	4.2500	165.100	6.5000	36.513	1.4375	36.513	1.4375	26.988	1.0625	3.6	3.2	56425/56650	1	231	300	42.9	38.5	121	120	153	148	157	5.5	9.5	3.6	3.2	0.50	1.21	0.66	2.57
	4.2500	190.500	7.5000	47.625	1.8750	49.212	1.9375	34.925	1.3750	3.6	3.2	71425/71750	1	381	483	60.9	40.9	121	131	179	167	177	6.4	12.7	3.6	3.2	0.42	1.44	0.79	5.48
4.2500	212.725	8.3750	66.675	2.6250	66.675	2.6250	53.975	2.1250	7.9	3.2	HH224340/HH224310	1	641	699	87.1	47.6	129	134	201	189	201	7	12.7	7.9	3.2	0.33	1.84	1.01	10.2	
109.987	4.3302	159.987	6.2987	34.925	1.3750	34.925	1.3750	26.988	1.0625	7.9	3.2	LM522548/LM522510	1	231	319	45.8	32.9	131	121	148	146	153	5.5	7.9	7.9	3.2	0.40	1.50	0.82	2.30
	4.3302	159.987	6.2987	34.925	1.3750	34.925	1.3750	26.988	1.0625	3.6	3.2	LM522549/LM522510	1	231	319	45.8	32.9	123	121	148	146	153	5.5	7.9	3.6	3.2	0.40	1.50	0.82	2.33
110	—	150	—	25	—	25	—	20	—	1.5	1.5	32922JR	1	162	231	33.3	26.3	119	118	141	138	145	5	5	1.5	1.5	0.36	1.69	0.93	1.28
110.000	4.3307	165.000	6.4961	35.000	1.3780	35.000	1.3780	26.500	1.0433	3.0	2.5	JM822049/JM822010	1	245	325	46.3	38.1	121	121	155	148	157	4.8	8.5	3.0	2.5	0.50	1.21	0.66	2.44
110	—	170	—	38	—	38	—	29	—	2.5	2	32022JR	1	312	395	56.7	36.1	122	122	160	152	163	7	9	2	2	0.43	1.39	0.77	3.12
	—	170	—	47	—	47	—	37	—	2.5	2	33022JR	1	360	502	64.9	33.4	122	123	160	152	161	7	10	2	2	0.29	2.09	1.15	3.81
110.000	4.3307	180.000	7.0866	47.000	1.8504	46.000	1.8110	38.000	1.4961	3.0	2.5	JHM522649/JHM522610	1	385	487	62.3	40.6	121	125	170	160	171	6	9	3.0	2.5	0.41	1.48	0.81	4.57
110	—	180	—	56	—	56	—	43	—	2.5	2	33122JR	1	464	634	78.6	44.5	122	121	170	155	174	9	13	2	2	0.42	1.43	0.79	5.52
	—	200	—	41	—	38	—	32	—	3	2.5	30222JR	1	405	434	58.1	40.8	124	129	188	174	188	6	9	2.5	2	0.42	1.43	0.79	5.33
	—	200	—	56	—	53	—	46	—	3	2.5	32222JR	1	547	640	80.4	46.7	124	126	188	170	190	6	10	2.5	2	0.42	1.43	0.79	7.45
	—	240	—	54.5	—	50	—	42	—	4	3	30322JR	1	601	590	75.2	46.3	128	141	226	206	222	8	12.5	3	2.5	0.35	1.74	0.96	11.4
114.300	4.5000	180.975	7.1250	34.925	1.3750	31.750	1.2500	25.400	1.0000	3.6	3.2	68450/68712	1	216	247	35.1	40.6	127	131	169	161	169	2.5	9.5	3.6	3.2	0.50	1.21	0.66	2.92
	4.5000	190.500	7.5000	47.625	1.8750	49.212	1.9375	34.925	1.3750	3.6	3.2	71450/71750	1	381	483	60.9	40.9	127	131	179	167	177	6.4	12.7	3.6	3.2	0.42	1.44	0.79	5.05

[Note] 1) While metric series bearings have minus tolerances for bore and OD, inch series have plus tolerances. Refer to page 194 for details of applicable tolerance standards.

Single-row tapered roller bearings

d (114.300) ~ (127.000) mm

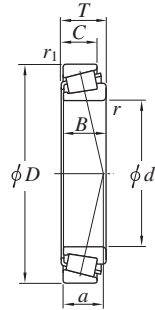

Design 1



Design 1-P

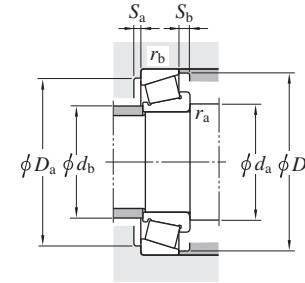

Boundary dimensions										Bearing No. ¹⁾	De- sign	Basic load ratings (kN)		Fatigue load limit (kN) <i>C_u</i>	Load center (mm) <i>a</i>	Mounting dimensions (mm)								Con- stant <i>e</i>	Axial load factors <i>Y₁</i> <i>Y₀</i>		(Refer.) Mass (kg)			
<i>d</i> mm	<i>D</i> mm	<i>T</i> mm	<i>B</i> mm	<i>C</i> mm	<i>r</i> min.	<i>r₁</i> min.	<i>C_r</i>	<i>C_{0r}</i>	<i>d_a</i> min.			<i>d_b</i> max.	<i>D_a</i> max.			<i>D_b</i> min.	<i>S_a</i> min.	<i>S_b</i> min.	<i>r_a</i> max.	<i>r_b</i> max.	<i>Y₁</i>	<i>Y₀</i>								
114.300	4.5000	212.725	8.3750	66.675	2.6250	66.675	2.6250	53.975	2.1250	7.1	3.2	HH224346/HH224310	1	641	699	87.1	47.6	134	134	201	189	201	7	12.7	7.1	3.2	0.33	1.84	1.01	9.67
	4.5000	228.600	9.0000	53.975	2.1250	49.428	1.9460	38.100	1.5000	3.6	3.2	97450/97900	1	408	459	55.5	65.6	127	144	217	193	212	5	15.9	3.6	3.2	0.74	0.81	0.45	9.17
	4.5000	228.600	9.0000	53.975	2.1250	49.428	1.9460	38.100	1.5000	3.6	3.2	HM926740/HM926710	1	540	651	77.1	67.9	127	148	217	200	218	7	15.9	3.6	3.2	0.74	0.81	0.45	10.0
	4.5000	273.050	10.7500	82.550	3.2500	82.550	3.2500	53.975	2.1250	6.4	6.4	HH926744/HH926710	1	885	898	104	76.1	133	151	255	230	252	7	28.6	6.4	6.4	0.63	0.95	0.52	21.9
114.976	4.5266	212.725	8.3750	66.675	2.6250	66.675	2.6250	53.975	2.1250	7.1	3.2	HH224349/HH224310	1	641	699	87.1	47.6	135	134	201	189	201	7	12.7	7.1	3.2	0.33	1.84	1.01	9.61
115.087	4.5310	190.500	7.5000	47.625	1.8750	49.212	1.9375	34.925	1.3750	7.9	3.2	71455/71750	1	381	483	60.9	40.9	136	131	179	167	177	6.4	12.7	7.9	3.2	0.42	1.44	0.79	4.97
117.475	4.6250	179.975	7.0856	34.925	1.3750	31.750	1.2500	25.400	1.0000	3.6	0.8	68462/68709	1	216	247	35.1	40.7	130	131	173	161	169	2.5	9.5	3.6	0.8	0.50	1.21	0.66	2.73
	4.6250	180.975	7.1250	34.925	1.3750	31.750	1.2500	25.400	1.0000	3.6	3.2	68462/68712	1	216	247	35.1	40.6	130	131	169	161	169	2.5	9.5	3.6	3.2	0.50	1.21	0.66	2.78
120	—	165	—	29	—	29	—	23	—	1.5	1.5	32924JR	1	215	298	42.5	29.4	129	128	156	152	160	6	6	1.5	1.5	0.35	1.72	0.95	1.77
	—	180	—	38	—	38	—	29	—	2.5	2	32024JR	1	325	427	60.0	38.8	132	131	170	161	173	7	9	2	2	0.46	1.31	0.72	3.34
	—	180	—	48	—	48	—	38	—	2.5	2	33024JR	1	375	540	68.5	36.2	132	132	170	160	171	6	10	2	2	0.31	1.97	1.08	4.16
	—	200	—	62	—	62	—	48	—	2.5	2	33124JR	1	581	785	96.1	47.8	132	133	190	172	192	9	14	2	2	0.40	1.51	0.83	7.73
	—	215	—	43.5	—	40	—	34	—	3	2.5	30224JR	1	435	473	61.7	44.2	134	140	203	187	203	6	9.5	2.5	2	0.44	1.38	0.76	6.36
	—	215	—	61.5	—	58	—	50	—	3	2.5	32224JR	1	589	691	84.0	51.6	134	136	203	181	204	7	11.5	2.5	2	0.44	1.38	0.76	9.04
120.000	4.7244	230.000	9.0551	53.975	2.1250	49.428	1.9460	38.100	1.5000	3.6	3.2	97472X/97905X	1	408	459	55.5	65.6	133	144	218	193	212	5	15.9	3.6	3.2	0.74	0.81	0.45	8.91
120	—	260	—	68	—	62	—	42	—	4	3	31324JR	1	657	665	77.8	81.9	138	145	246	221	244	6	21	3	2.5	0.83	0.73	0.40	15.4
120.650	4.7500	234.950	9.2500	63.500	2.5000	63.500	2.5000	49.213	1.9375	6.4	3.2	95475/95925	1	656	826	100	49.9	139	155	223	204	216	8	14.3	6.4	3.2	0.37	1.62	0.89	12.3
123.825	4.8750	182.563	7.1875	39.688	1.5625	38.100	1.5000	33.338	1.3125	3.6	3.2	48286/48220	1	284	429	59.8	34.1	136	141	171	166	173	3.8	6.4	3.6	3.2	0.31	1.97	1.08	3.42
125.298	4.9330	228.600	9.0000	53.975	2.1250	49.428	1.9460	38.100	1.5000	3.6	3.2	HM926745/HM926710	1	540	651	77.1	68.1	138	148	217	200	218	7	15.9	3.6	3.2	0.74	0.81	0.45	9.23
127.000	5.0000	182.563	7.1875	39.688	1.5625	38.100	1.5000	33.338	1.3125	3.6	3.2	48290/48220	1	284	429	59.8	34.1	140	141	171	166	173	3.8	6.4	3.6	3.2	0.31	1.97	1.08	3.24
	5.0000	196.850	7.7500	46.038	1.8125	46.038	1.8125	38.100	1.5000	3.6	3.2	67388/67322	1	390	561	68.7	39.7	140	148	185	180	188	5	7.9	3.6	3.2	0.34	1.74	0.96	5.05
	5.0000	203.200	8.0000	46.038	1.8125	46.038	1.8125	38.100	1.5000	3.6	3.2	67388/67320	1	390	561	68.7	39.7	140	148	191	180	188	5	7.9	3.6	3.2	0.34	1.74	0.96	5.64
	5.0000	215.900	8.5000	47.625	1.8750	47.625	1.8750	34.925	1.3750	3.6	3.2	74500/74850	1	403	549	66.1	49.7	140	156	204	193	204	5	12.7	3.6	3.2	0.49	1.23	0.68	6.83

[Note] 1) While metric series bearings have minus tolerances for bore and OD, inch series have plus tolerances. Refer to page 194 for details of applicable tolerance standards.

Single-row tapered roller bearings

d (127.000) ~ (139.700) mm

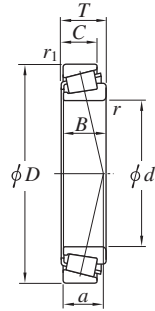

Design 1



Design 1-P

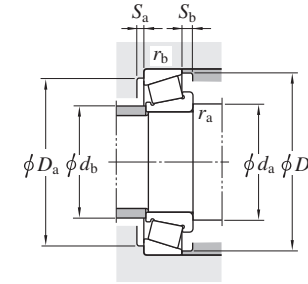

Boundary dimensions										Bearing No. ¹⁾	De- sign	Basic load ratings (kN)		Fatigue load limit (kN) <i>C_u</i>	Load center (mm) <i>a</i>	Mounting dimensions (mm)								Con- stant <i>e</i>	Axial load factors <i>Y₁</i> <i>Y₀</i>		(Refer.) Mass (kg)			
<i>d</i>	<i>D</i>	<i>T</i>	<i>B</i>	<i>C</i>	<i>r</i>	<i>r₁</i>	<i>C_r</i>	<i>C_{0r}</i>	<i>d_a</i>			<i>d_b</i>	<i>D_a</i>			<i>D_b</i>	<i>S_a</i>	<i>S_b</i>	<i>r_a</i>	<i>r_b</i>										
mm	1/25.4	mm	1/25.4	mm	1/25.4	mm	1/25.4	mm	1/25.4	min.	min.	min.	max.	max.	min.	min.	min.	max.	max.											
127.000	5.0000	228.600	9.0000	53.975	2.1250	49.428	1.9460	38.100	1.5000	3.6	3.2	HM926747/HM926710	1	540	651	77.1	68.1	140	148	217	200	218	7	15.9	3.6	3.2	0.74	0.81	0.45	9.10
	5.0000	234.950	9.2500	63.500	2.5000	63.500	2.5000	49.213	1.9375	6.4	3.2	95500/95925	1	656	826	100	49.9	145	155	223	204	216	8	14.3	6.4	3.2	0.37	1.62	0.89	11.7
	5.0000	254.000	10.0000	77.788	3.0625	82.550	3.2500	61.912	2.4375	9.5	6.4	HH228349/HH228310	1	895	1 050	125	54.3	151	158	236	219	233	9	15.9	9.5	6.4	0.32	1.87	1.03	17.8
	5.0000	304.800	12.0000	88.900	3.5000	82.550	3.2500	57.150	2.2500	6.4	6.4	HH932132/HH932110	1	987	1 060	119	92.1	145	178	287	259	287	7	31.8	6.4	6.4	0.73	0.82	0.45	29.5
127.792	5.0312	228.600	9.0000	53.975	2.1250	49.428	1.9460	38.100	1.5000	3.6	3.2	HM926749/HM926710	1	540	651	77.1	68.1	140	148	217	200	218	7	15.9	3.6	3.2	0.74	0.81	0.45	9.04
128.588	5.0625	206.375	8.1250	47.625	1.8750	47.625	1.8750	34.925	1.3750	3.2	3.2	799/792	1	409	548	67.2	45.7	140	146	195	183	194	6	12.7	3.2	3.2	0.46	1.31	0.72	5.82
130	—	180	—	32	—	32	—	25	—	2	1.5	32926JR	1	251	368	51.2	31.4	140	141	171	165	174	6	7	2	1.5	0.34	1.77	0.97	2.42
	—	200	—	45	—	45	—	34	—	2.5	2	32026JR	1	145	563	21.8	42.9	142	144	190	178	192	8	11	2	2	0.43	1.38	0.76	5.04
	—	200	—	55	—	55	—	43	—	2.5	2	33026JR	1	489	705	85.8	42.5	142	143	190	178	192	8	12	2	2	0.34	1.76	0.97	6.19
130.000	5.1181	206.375	8.1250	47.625	1.8750	47.625	1.8750	34.925	1.3750	3.6	3.2	797/792	1	409	548	67.2	45.7	143	146	195	183	194	6	12.7	3.6	3.2	0.46	1.31	0.72	5.71
130	—	230	—	43.75	—	40	—	34	—	4	3	30226JR	1	472	511	65.7	46.2	148	152	216	203	218	7	9.5	3	2.5	0.44	1.38	0.76	7.24
	—	230	—	67.75	—	64	—	54	—	4	3	32226JR	1	693	830	99.9	56.0	148	146	216	193	219	7	13.5	3	2.5	0.44	1.38	0.76	11.5
	—	280	—	63.75	—	58	—	49	—	5	4	30326JR	1	823	834	102	54.0	152	164	262	239	255	8	14.5	4	3	0.35	1.74	0.96	18.1
	—	280	—	72	—	66	—	44	—	5	4	31326JR	1	734	748	85.7	87.3	152	155	262	236	261	7	23	4	3	0.83	0.73	0.40	18.9
133.350	5.2500	177.008	6.9688	25.400	1.0000	26.195	1.0313	20.638	0.8125	1.6	1.6	L327249/L327210	1	176	278	38.2	29.1	142	145	168	164	169	5.4	4.8	1.6	1.6	0.35	1.72	0.95	1.69
	5.2500	190.500	7.5000	39.688	1.5625	39.688	1.5625	33.338	1.3125	3.6	3.2	48385/48320	1	172	472	33.3	35.9	146	150	179	174	181	4.7	6.4	3.6	3.2	0.32	1.87	1.03	3.58
	5.2500	196.850	7.7500	46.038	1.8125	46.038	1.8125	38.100	1.5000	7.9	3.2	67391/67322	1	390	561	68.7	39.7	155	148	185	180	188	5	7.9	7.9	3.2	0.34	1.74	0.96	4.55
	5.2500	215.900	8.5000	47.625	1.8750	47.625	1.8750	34.925	1.3750	3.6	3.2	74525/74850	1	403	549	66.1	49.7	146	156	204	193	204	5	12.7	3.6	3.2	0.49	1.23	0.68	6.35
	5.2500	234.950	9.2500	63.500	2.5000	63.500	2.5000	49.213	1.9375	9.5	3.2	95525/95925	1	656	826	100	49.9	158	155	223	204	216	8	14.3	9.5	3.2	0.37	1.62	0.89	11.0
136.525	5.3750	190.500	7.5000	39.688	1.5625	39.688	1.5625	33.338	1.3125	3.6	3.2	48393/48320	1	172	472	33.3	35.9	149	150	179	174	181	4.7	6.4	3.6	3.2	0.32	1.87	1.03	3.37
	5.3750	228.600	9.0000	57.150	2.2500	57.150	2.2500	44.450	1.7500	3.6	3.2	896/892	1	552	730	87.3	50.6	149	158	217	201	214	6	12.7	3.6	3.2	0.42	1.43	0.78	8.98
139.700	5.5000	215.900	8.5000	47.625	1.8750	47.625	1.8750	34.925	1.3750	3.6	3.2	74550/74850	1	403	549	66.1	49.7	152	156	204	193	204	5	12.7	3.6	3.2	0.49	1.23	0.68	5.84
	5.5000	215.900	8.5000	47.625	1.8750	47.625	1.8750	34.925	1.3750	6.4	3.2	74550A/74850	1	403	549	66.1	49.7	158	156	204	193	204	5	12.7	6.4	3.2	0.49	1.23	0.68	5.82
	5.5000	228.600	9.0000	57.150	2.2500	57.150	2.2500	44.450	1.7500	3.6	3.2	898/892	1	552	730	87.3	50.6	152	158	217	201	214	6	12.7	3.6	3.2	0.42	1.43	0.78	8.68

[Note] 1) While metric series bearings have minus tolerances for bore and OD, inch series have plus tolerances. Refer to page 194 for details of applicable tolerance standards.

Single-row tapered roller bearings

d (139.700) ~ (150) mm

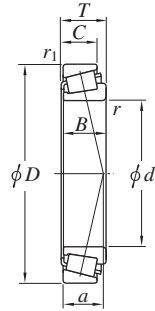

Design 1



Design 1-P

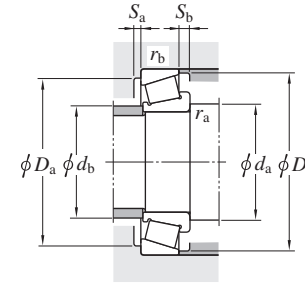

Boundary dimensions										Bearing No. ¹⁾	De- sign	Basic load ratings (kN)		Fatigue load limit (kN) C_u	Load center (mm) a	Mounting dimensions (mm)								Con- stant e	Axial load factors Y_1 Y_0		(Refer.) Mass (kg)			
d mm	D mm	T mm	B mm	C mm	r min.	r_1 min.	C_r	C_{Or}	d_a min.			d_b max.	D_a max.			D_b min.	S_a min.	S_b min.	r_a max.	r_b max.	d_a min.	d_b max.								
139.700	5.5000	228.600	9.0000	57.150	2.2500	57.150	2.2500	44.450	1.7500	6.4	3.2	898A/892	1	552	730	87.3	50.6	158	158	217	201	214	6	12.7	6.4	3.2	0.42	1.43	0.78	8.66
	5.5000	236.538	9.3125	57.150	2.2500	56.642	2.2300	44.450	1.7500	3.6	3.2	HM231132/HM231110	1	628	832	98.8	45.2	152	168	225	213	222	8	12.7	3.6	3.2	0.32	1.88	1.04	10.1
	5.5000	254.000	10.0000	66.675	2.6250	66.675	2.6250	47.625	1.8750	7.1	3.2	99550/99100	1	690	913	107	55.0	159	174	242	223	236	8	19.1	7.1	3.2	0.41	1.47	0.81	14.1
	5.5000	295.275	11.6250	82.550	3.2500	87.313	3.4375	57.150	2.2500	9.5	6.4	HH231649/HH231615	1	1 020	1 090	130	56.3	164	176	277	252	264	11	25.4	9.5	6.4	0.32	1.88	1.04	24.9
140	—	190	—	32	—	32	—	25	—	2	1.5	32928JR	1	258	390	53.2	33.6	150	150	181	174	184	6	7	2	1.5	0.36	1.67	0.92	2.57
	—	210	—	45	—	45	—	34	—	2.5	2	32028JR	1	435	585	79.2	45.6	152	153	200	187	202	8	11	2	2	0.46	1.31	0.72	5.28
	—	210	—	56	—	56	—	44	—	2.5	2	33028JR	1	510	758	90.9	45.6	152	152	200	186	202	7	12	2	2	0.36	1.67	0.92	6.61
140.000	5.5118	215.000	8.4646	47.625	1.8750	47.625	1.8750	34.925	1.3750	3.6	3.2	74551X/74846X	1	403	549	66.1	49.7	153	156	203	193	204	5	12.7	3.6	3.2	0.49	1.23	0.68	5.74
140	—	250	—	71.75	—	68	—	58	—	4	3	32228JR	1	796	961	112	60.0	158	158	236	210	238	9	13.5	3	2.5	0.44	1.38	0.76	14.7
	—	300	—	77	—	70	—	47	—	5	4	31328JR	1	841	865	99.1	93.8	162	167	282	254	280	8	26	4	3	0.83	0.73	0.40	23.3
142.875	5.6250	193.675	7.6250	28.575	1.1250	28.575	1.1250	23.020	0.9063	1.6	1.6	36686/36620	1	234	375	50.6	33.7	152	158	185	179	185	5.5	5.6	1.6	1.6	0.37	1.63	0.90	2.41
	5.6250	200.025	7.8750	41.275	1.6250	39.688	1.5625	34.130	1.3437	3.6	3.3	48685/48620	1	307	491	66.5	38.4	156	157	188	182	190	4	7.1	3.6	3.3	0.34	1.78	0.98	3.84
	5.6250	222.250	8.7500	34.925	1.3750	31.623	1.2450	23.813	0.9375	3.6	3.2	73562/73875	1	263	302	40.8	41.9	156	163	210	197	204	4	11.1	3.6	3.2	0.44	1.37	0.75	4.15
	5.6250	241.300	9.5000	57.150	2.2500	56.642	2.2300	44.450	1.7500	3.6	3.2	HM231136/HM231115	1	628	832	98.8	45.2	156	168	229	213	222	8	12.7	3.6	3.2	0.32	1.88	1.04	10.4
146.050	5.7500	193.675	7.6250	28.575	1.1250	28.575	1.1250	23.020	0.9063	1.6	1.6	36690/36620	1	234	375	50.6	33.7	155	158	185	179	185	5.5	5.6	1.6	1.6	0.37	1.63	0.90	2.25
	5.7500	193.675	7.6250	28.575	1.1250	28.575	1.1250	23.020	0.9063	4.8	1.6	36691/36620	1	234	375	50.6	33.7	161	158	185	179	185	5.5	5.6	4.8	1.6	0.37	1.63	0.90	2.23
	5.7500	236.538	9.3125	57.150	2.2500	56.642	2.2300	44.450	1.7500	3.6	3.2	HM231140/HM231110	1	628	832	98.8	45.2	159	168	225	213	222	8	12.7	3.6	3.2	0.32	1.88	1.04	9.45
	5.7500	241.300	9.5000	57.150	2.2500	56.642	2.2300	44.450	1.7500	3.6	3.2	82576/82950	1	527	728	85.3	53.4	159	169	229	211	224	7	12.7	3.6	3.2	0.44	1.36	0.75	10.0
	5.7500	268.288	10.5625	74.613	2.9375	74.613	2.9375	57.150	2.2500	6.4	6.4	EE107057/107105	1	825	1 050	120	59.4	164	178	250	234	249	8	17.5	6.4	6.4	0.39	1.55	0.85	17.9
	5.7500	304.800	12.0000	88.900	3.5000	82.550	3.2500	57.150	2.2500	6.4	6.4	HH932145/HH932110	1	987	1 060	119	92.1	164	178	287	259	287	7	31.8	6.4	6.4	0.73	0.82	0.45	26.9
149.225	5.8750	236.538	9.3125	57.150	2.2500	56.642	2.2300	44.450	1.7500	3.6	3.2	82587/82931	1	527	728	85.3	53.4	162	169	225	211	224	7	12.7	3.6	3.2	0.44	1.36	0.75	9.07
	5.8750	236.538	9.3125	57.150	2.2500	56.642	2.2300	44.450	1.7500	6.4	3.2	HM231148/HM231110	1	628	832	98.8	45.2	167	168	225	213	222	8	12.7	6.4	3.2	0.32	1.88	1.04	9.10
	5.8750	236.538	9.3125	57.150	2.2500	56.642	2.2300	44.450	1.7500	3.6	3.2	HM231149/HM231110	1	628	832	98.8	45.2	162	168	225	213	222	8	12.7	3.6	3.2	0.32	1.88	1.04	9.13
150	—	210	—	38	—	38	—	30	—	2.5	2	32930JR	1	358	536	72.1	36.1	162	163	200	194	202	7	8	2	2	0.33	1.83	1.01	3.96
	—	225	—	48	—	48	—	36	—	3	2.5	32030JR	1	492	668	79.6	48.8	164	164	213	200	216	8	12	2.5	2	0.46	1.31	0.72	6.41

[Note] 1) While metric series bearings have minus tolerances for bore and OD, inch series have plus tolerances. Refer to page 194 for details of applicable tolerance standards.

Single-row tapered roller bearings

d (150) ~ 168.275 mm

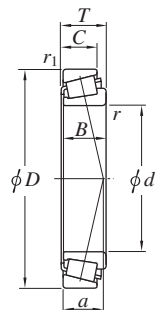

Design 1



Design 1-P

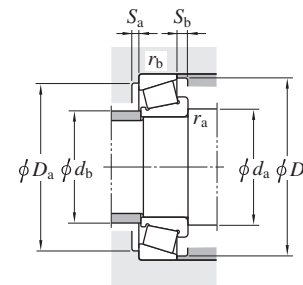

Boundary dimensions										Bearing No. ¹⁾	De- sign	Basic load ratings (kN)		Fatigue load limit (kN) C_u	Load center (mm) a	Mounting dimensions (mm)								Con- stant e	Axial load factors Y_1 Y_0		(Refer.) Mass (kg)			
d mm	D mm	T mm	B mm	C mm	r min.	r_1 min.	C_r	C_{Or}	d_a min.			d_b max.	D_a max.			D_b min.	S_a min.	S_b min.	r_a max.	r_b max.	e	Y_1	Y_0							
150	—	225	—	59	—	59	—	46	—	3	2.5	33030JR	1	575	869	101	47.8	164	164	213	200	217	8	13	2.5	2	0.36	1.65	0.90	8.09
	—	270	—	77	—	73	—	60	—	4	3	32230JR	1	881	1 070	122	65.2	168	170	256	226	254	8	17	3	2.5	0.44	1.38	0.76	18.2
	—	320	—	82	—	75	—	50	—	5	4	31330JR	1	952	989	110	100.1	172	179	302	272	301	9	27	4	3	0.83	0.73	0.40	28.0
152.400	6.0000	254.000	10.0000	66.675	2.6250	66.675	2.6250	47.625	1.8750	7.1	3.2	99600/99100	1	690	913	107	55.0	172	174	242	223	236	8	19.1	7.1	3.2	0.41	1.47	0.81	12.6
	6.0000	254.000	10.0000	66.675	2.6250	71.438	2.8125	47.625	1.8750	1.6	3.2	99603/99100	1	690	913	107	55.0	161	174	242	223	236	8	19.1	1.6	3.2	0.41	1.47	0.81	12.8
	6.0000	268.288	10.5625	74.613	2.9375	74.613	2.9375	57.150	2.2500	6.4	6.4	EE107060/107105	1	825	1 050	120	59.4	171	178	250	234	249	8	17.5	6.4	6.4	0.39	1.55	0.85	17.1
	6.0000	269.799	10.6220	74.612	2.9375	74.613	2.9375	57.150	2.2500	6.4	6.4	EE107060/107107	1	825	1 050	120	59.4	171	178	252	234	249	8	17.5	6.4	6.4	0.39	1.55	0.85	17.4
	6.0000	307.975	12.1250	88.900	3.5000	93.663	3.6875	61.913	2.4375	9.5	6.7	EE450601/451212	1	993	1 150	134	61.4	177	193	289	261	274	7	27	9.5	6.7	0.33	1.84	1.01	28.1
	6.0000	307.975	12.1250	88.900	3.5000	93.663	3.6875	66.675	2.6250	9.5	6.7	HH234048/HH234010	1	1 270	1 450	165	63.3	177	191	289	270	285	8	22.2	9.5	6.7	0.33	1.84	1.01	29.4
	6.0000	317.500	12.5000	88.900	3.5000	93.663	3.6875	66.675	2.6250	9.5	6.7	HH234048/HH234018	1	1 270	1 450	165	63.3	177	191	299	270	285	8	22.2	9.5	6.7	0.33	1.84	1.01	31.9
155.575	6.1250	330.200	13.0000	85.725	3.3750	79.375	3.1250	53.975	2.1250	6.4	6.4	H936340/H936310	1	1 080	1 210	131	103.8	174	196	312	281	311	6	31.8	6.4	6.4	0.81	0.74	0.41	31.4
160	—	220	—	38	—	38	—	30	—	2.5	2	32932JR	1	368	568	75.2	38.4	172	173	210	204	212	7	8	2	2	0.35	1.73	0.95	4.19
	—	240	—	51	—	51	—	38	—	3	2.5	32032JR	1	553	758	90.3	52.1	174	175	228	213	231	8	13	2.5	2	0.46	1.31	0.72	7.75
	—	290	—	84	—	80	—	67	—	4	3	32232JR	1	994	1 210	137	70.3	178	182	276	242	274	10	17	3	2.5	0.44	1.38	0.76	23.2
160.325	6.3120	288.925	11.3750	63.500	2.5000	63.500	2.5000	47.625	1.8750	7.1	3.2	HM237532/HM237510	1	788	973	111	52.2	180	203	277	260	270	8	15.9	7.1	3.2	0.32	1.88	1.04	17.0
161.925	6.3750	374.650	14.7500	87.313	3.4375	79.375	3.1250	60.325	2.3750	6.4	3.2	EE117063/117148	1	1 100	1 220	132	103.7	180	218	363	308	337	7	27	6.4	3.2	0.73	0.82	0.45	43.7
165.100	6.5000	247.650	9.7500	47.625	1.8750	47.625	1.8750	38.100	1.5000	3.6	3.2	67780/67720	1	432	701	79.8	52.3	178	193	236	226	237	5	9.5	3.6	3.2	0.44	1.36	0.75	7.92
	6.5000	254.000	10.0000	46.038	1.8125	46.038	1.8125	33.338	1.3125	4.8	3.2	M235145/M235113	1	476	620	81.0	41.5	180	191	242	232	239	7	12.7	4.8	3.2	0.32	1.88	1.04	7.87
	6.5000	288.925	11.3750	63.500	2.5000	63.500	2.5000	47.625	1.8750	7.1	3.2	HM237535/HM237510	1	788	973	111	52.2	185	203	277	260	270	8	15.9	7.1	3.2	0.32	1.88	1.04	16.4
	6.5000	289.975	11.4163	63.500	2.5000	63.500	2.5000	48.000	1.8898	7.1	3	HM237535/HM237513	1	788	973	111	52.2	185	203	279	260	270	8	15.5	7.1	3	0.32	1.88	1.04	16.6
	6.5000	336.550	13.2500	92.075	3.6250	95.250	3.7500	69.850	2.7500	3.2	6.4	HH437549/HH437510	1	1 310	1 630	177	70.7	177	215	318	290	307	12	22.2	3.2	6.4	0.37	1.62	0.89	38.5
	6.5000	360.000	14.1732	92.075	3.6250	88.897	3.4999	63.500	2.5000	9.5	3.2	EE420651/421417	1	1 180	1 460	159	75.6	190	243	348	317	334	6	28.6	9.5	3.2	0.40	1.49	0.82	42.9
168.275	6.6250	247.650	9.7500	47.625	1.8750	47.625	1.8750	38.100	1.5000	3.6	3.2	67782/67720	1	432	701	79.8	52.3	181	193	236	226	237	5	9.5	3.6	3.2	0.44	1.36	0.75	7.61
	6.6250	330.200	13.0000	85.725	3.3750	79.375	3.1250	53.975	2.1250	6.4	6.4	H936349/H936310	1	1 080	1 210	131	103.8	187	196	312	281	311	6	31.8	6.4	6.4	0.81	0.74	0.41	29.5
	6.6250	342.900	13.5000	85.725	3.3750	79.375	3.1250	53.975	2.1250	6.4	6.4	H936349/H936316	1	1 080	1 210	131	103.8	187	196	325	281	311	6	31.8	6.4	6.4	0.81	0.74	0.41	32.3

[Note] 1) While metric series bearings have minus tolerances for bore and OD, inch series have plus tolerances. Refer to page 194 for details of applicable tolerance standards.

Single-row tapered roller bearings

d 170 ~ (177.800) mm

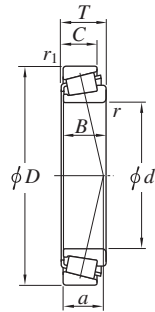

Design 1



Design 1-P

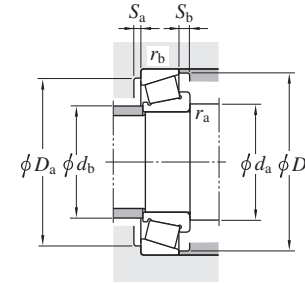

Boundary dimensions										Bearing No. ¹⁾	De- sign	Basic load ratings (kN)		Fatigue load limit (kN) C_u	Load center (mm) a	Mounting dimensions (mm)								Con- stant e	Axial load factors Y_1 Y_0		(Refer.) Mass (kg)			
d mm	D mm	T mm	B mm	C mm	r min.	r_1 min.	C_r	C_{Or}	d_a min.			d_b max.	D_a max.			D_b min.	S_a min.	S_b min.	r_a max.	r_b max.	e	Y_1	Y_0							
170	—	230	—	38	—	38	—	30	—	2.5	2	32934JR	1	370	606	78.8	42.0	182	183	220	213	222	7	8	2	2	0.38	1.57	0.86	4.49
170.000	6.6929	230.000	9.0551	39.000	1.5354	38.000	1.4961	31.000	1.2205	3.0	2.5	JHM534149/JHM534110	1	363	558	72.8	43.6	181	184	220	214	222	7	8	3.0	2.5	0.38	1.57	0.86	4.46
	6.6929	240.000	9.4488	46.000	1.8110	44.500	1.7520	37.000	1.4567	3.0	2.5	JM734449/JM734410	1	443	666	77.1	50.6	181	184	230	220	231	7	9	3.0	2.5	0.44	1.37	0.75	6.31
	6.6929	254.000	10.0000	46.038	1.8125	46.038	1.8125	33.338	1.3125	4.8	3.2	86669/86100	1	422	531	69.4	44.9	185	189	242	230	238	6	12.7	4.8	3.2	0.37	1.63	0.90	7.01
	6.6929	254.000	10.0000	46.038	1.8125	46.038	1.8125	33.338	1.3125	4.8	3.2	M235149/M235113	1	476	620	81.0	41.5	185	191	242	232	239	7	12.7	4.8	3.2	0.32	1.88	1.04	7.41
170	—	260	—	57	—	57	—	43	—	3	2.5	32034JR	1	661	905	105	55.8	184	187	248	230	249	10	14	2.5	2	0.44	1.35	0.74	10.5
170.000	6.6929	266.700	10.5000	46.038	1.8125	46.038	1.8125	33.338	1.3125	4.8	1.6	86669/86105	1	422	531	69.4	44.9	185	189	258	230	238	6	12.7	4.8	1.6	0.37	1.63	0.90	8.36
171.450	6.7500	288.925	11.3750	63.500	2.5000	63.500	2.5000	47.625	1.8750	7.1	3.2	94675/94113A	1	691	960	108	63.2	191	204	277	255	269	8	15.9	7.1	3.2	0.47	1.28	0.70	16.2
	6.7500	298.450	11.7500	63.500	2.5000	63.500	2.5000	47.625	1.8750	7.1	3.2	94675/94118	1	691	960	108	63.2	191	204	287	255	269	8	15.9	7.1	3.2	0.47	1.28	0.70	17.8
174.625	6.8750	247.650	9.7500	47.625	1.8750	47.625	1.8750	38.100	1.5000	3.6	3.2	67787/67720	1	432	701	79.8	52.3	187	193	236	226	237	5	9.5	3.6	3.2	0.44	1.36	0.75	6.98
	6.8750	288.925	11.3750	63.500	2.5000	63.500	2.5000	47.625	1.8750	7.1	3.2	94687/94113	1	691	960	108	63.2	194	204	277	255	269	8	15.9	7.1	3.2	0.47	1.28	0.70	15.8
	6.8750	288.925	11.3750	63.500	2.5000	63.500	2.5000	47.625	1.8750	7.1	3.2	HM237542/HM237510	1	788	973	111	52.2	194	203	277	260	270	8	15.9	7.1	3.2	0.32	1.88	1.04	15.1
	6.8750	311.150	12.2500	82.550	3.2500	82.550	3.2500	65.088	2.5625	6.4	6.4	H238148/H238110	1	1 080	1 340	151	64.3	193	207	293	273	287	8	17.5	6.4	6.4	0.33	1.82	1.00	25.3
177.800	7.0000	227.013	8.9375	30.163	1.1875	30.163	1.1875	23.020	0.9063	1.6	1.6	36990/36920	1	222	402	51.2	43.0	186	191	218	212	219	6	7.1	1.6	1.6	0.44	1.36	0.75	2.85
	7.0000	247.650	9.7500	47.625	1.8750	47.625	1.8750	38.100	1.5000	3.6	3.2	67790/67720	1	432	701	79.8	52.3	190	193	236	226	237	5	9.5	3.6	3.2	0.44	1.36	0.75	6.65
	7.0000	247.650	9.7500	47.625	1.8750	47.625	1.8750	38.100	1.5000	10.4	3.2	67791/67720	1	432	701	79.8	52.3	204	193	236	226	237	5	9.5	10.4	3.2	0.44	1.36	0.75	6.56
	7.0000	260.350	10.2500	53.975	2.1250	53.975	2.1250	41.275	1.6250	3.6	3.2	M236849/M236810	1	554	821	95.7	48.4	190	199	249	237	246	5	12.7	3.6	3.2	0.33	1.80	0.99	8.94
	7.0000	285.750	11.2500	63.500	2.5000	63.500	2.5000	41.275	1.6250	6.4	3.2	EE91702/91112	1	188	716	27.0	58.8	196	205	274	251	263	4	22.2	6.4	3.2	0.43	1.39	0.77	13.4
	7.0000	288.925	11.3750	63.500	2.5000	63.500	2.5000	47.625	1.8750	7.1	3.2	94700/94113	1	691	960	108	63.2	197	204	277	255	269	8	15.9	7.1	3.2	0.47	1.28	0.70	15.3
	7.0000	288.925	11.3750	63.500	2.5000	63.500	2.5000	47.625	1.8750	7.1	3.2	HM237545/HM237510	1	788	973	111	52.2	197	203	277	260	270	8	15.9	7.1	3.2	0.32	1.88	1.04	14.7
	7.0000	319.964	12.5970	88.900	3.5000	85.725	3.3750	65.088	2.5625	3.6	4.8	EE222070/222126	1	938	1 220	136	72.9	190	216	305	280	297	4	23.8	3.6	4.8	0.40	1.49	0.82	28.0
	7.0000	319.964	12.5970	88.900	3.5000	85.725	3.3750	65.088	2.5625	3.6	4.8	H239640/H239610	1	1 070	1 270	142	66.1	190	214	305	286	300	5	23.8	3.6	4.8	0.32	1.88	1.04	26.9
	7.0000	320.675	12.6250	88.900	3.5000	85.725	3.3750	65.088	2.5625	3.6	4.8	EE222070/222128	1	938	1 220	136	72.9	190	216	306	280	297	4	23.8	3.6	4.8	0.40	1.49	0.82	28.2
	7.0000	327.025	12.8750	90.488	3.5625	92.075	3.6250	63.500	2.5000	6.4	6.4	EE470078/470128	1	1 090	1 430	159	68.3	196	225	309	289	305	7	27	6.4	6.4	0.37	1.63	0.90	31.1
	7.0000	336.550	13.2500	90.488	3.5625	92.075	3.6250	63.500	2.5000	13.5	6.4	EE470073/470132	1	1 090	1 430	159	68.3	210	225	318	289	305	7	27	13.5	6.4	0.37	1.63	0.90	33.4

[Note] 1) While metric series bearings have minus tolerances for bore and OD, inch series have plus tolerances. Refer to page 194 for details of applicable tolerance standards.

Single-row tapered roller bearings

d (177.800) ~ (190.500) mm

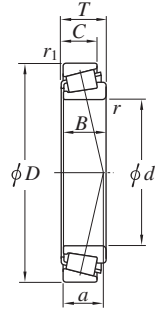

Design 1



Design 1-P

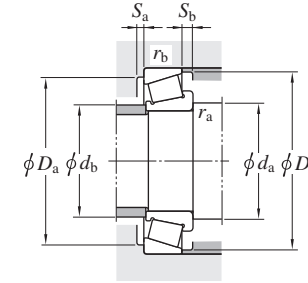

Boundary dimensions										Bearing No. ¹⁾	De- sign	Basic load ratings (kN)		Fatigue load limit (kN) C_u	Load center (mm) a	Mounting dimensions (mm)								Con- stant e	Axial load factors Y_1 Y_0		(Refer.) Mass (kg)			
d mm	D mm	T mm	B mm	C mm	r min.	r_1 min.	C_r	C_{Or}	d_a min.			d_b max.	D_a max.			D_b min.	S_a min.	S_b min.	r_a max.	r_b max.	e	Y_1	Y_0							
177.800	7.0000	360.000	14.1732	92.075	3.6250	88.897	3.4999	63.500	2.5000	12.7	3.2	EE420701/421417	1	1 180	1 460	159	75.6	209	243	348	317	334	6	28.6	12.7	3.2	0.40	1.49	0.82	40.5
	7.0000	365.049	14.3720	92.075	3.6250	88.897	3.4999	63.500	2.5000	12.7	3.2	EE420701/421437	1	1 180	1 460	159	75.6	209	243	353	317	334	6	28.6	12.7	3.2	0.40	1.49	0.82	41.9
	7.0000	428.625	16.8750	106.362	4.1875	95.250	3.7500	61.912	2.4375	6.4	6.4	EE350701/351687	1	1 340	1 390	145	118.7	196	238	410	350	381	9	44.5	6.4	6.4	0.76	0.79	0.44	64.6
179.975	7.0856	317.500	12.5000	63.500	2.5000	63.500	2.5000	46.038	1.8125	3.6	3.2	93708/93125	1	757	1 130	122	71.4	193	227	306	278	294	7	17.5	3.6	3.2	0.52	1.15	0.63	20.8
180	—	250	—	45	—	45	—	34	—	2.5	2	32936JR	1	447	735	93.4	53.5	192	193	240	225	241	8	11	2	2	0.48	1.25	0.69	6.64
180.000	7.0866	250.000	9.8425	47.000	1.8504	45.000	1.7717	37.000	1.4567	3.0	2.5	JM736149/JM736110	1	456	705	81.7	55.2	191	193	240	230	242	7	10	3.0	2.5	0.48	1.25	0.69	6.56
180	—	280	—	64	—	64	—	48	—	3	2.5	32036JR	1	810	1 100	127	59.5	194	199	268	247	268	10	16	2.5	2	0.42	1.42	0.78	14.1
	—	320	—	57	—	52	—	43	—	5	4	30236JR	1	771	870	102	63.6	202	211	302	278	297	9	14	4	3	0.45	1.33	0.73	18.3
	—	320	—	91	—	86	—	71	—	5	4	32236JR	1	1 200	1 520	164	77.8	202	204	302	267	303	10	20	4	3	0.45	1.33	0.73	29.9
184.150	7.2500	266.700	10.5000	47.625	1.8750	46.833	1.8438	38.100	1.5000	3.6	3.2	67883/67820	1	425	703	78.2	57.8	197	211	255	245	257	6	9.5	3.6	3.2	0.48	1.26	0.69	8.55
	7.2500	279.997	11.0235	46.525	1.8317	46.833	1.8438	36.000	1.4173	3.6	3.2	67883/67830	1	425	703	78.2	56.7	197	211	268	245	256	7	10.5	3.6	3.2	0.48	1.26	0.69	10.0
187.325	7.3750	269.875	10.6250	55.563	2.1875	55.563	2.1875	42.863	1.6875	3.6	3.2	M238849/M238810	1	514	805	91.6	49.9	200	209	258	245	255	5	12.7	3.6	3.2	0.33	1.80	0.99	9.66
	7.3750	319.964	12.5970	88.900	3.5000	85.725	3.3750	65.088	2.5625	5.6	4.8	H239649/H239610	1	1 070	1 270	142	66.1	204	214	305	286	300	5	23.8	5.6	4.8	0.32	1.88	1.04	25.1
	7.3750	320.675	12.6250	88.900	3.5000	85.725	3.3750	65.088	2.5625	5.6	4.8	H239649/H239612	1	1 070	1 270	142	66.1	204	214	306	286	300	5	23.8	5.6	4.8	0.32	1.88	1.04	25.3
190	—	260	—	45	—	45	—	34	—	2.5	2	32938JR	1	459	789	88.6	55.0	202	204	250	235	252	8	11	2	2	0.48	1.26	0.69	6.89
190.000	7.4803	260.000	10.2362	46.000	1.8110	44.000	1.7323	36.500	1.4370	3.0	2.5	JM738249/JM738210	1	461	723	81.4	56.0	201	203	250	240	251	7	9.5	3.0	2.5	0.48	1.26	0.69	6.89
190	—	290	—	64	—	64	—	48	—	3	2.5	32038JR	1	823	1 170	131	62.9	204	209	278	257	279	10	16	2.5	2	0.44	1.36	0.75	14.7
	—	340	—	60	—	55	—	46	—	5	4	30238JR	1	912	1 030	118	66.4	212	225	322	298	318	12	13	4	3	0.44	1.38	0.76	21.9
	—	340	—	97	—	92	—	75	—	5	4	32238JR	1	1 370	1 740	187	81.9	212	216	322	286	323	12	22	4	3	0.44	1.38	0.76	36.6
190.500	7.5000	266.700	10.5000	47.625	1.8750	46.833	1.8438	38.100	1.5000	3.6	3.2	67885/67820	1	425	703	78.2	57.8	203	211	255	245	257	6	9.5	3.6	3.2	0.48	1.26	0.69	7.88
	7.5000	282.575	11.1250	50.800	2.0000	47.625	1.8750	36.512	1.4375	3.6	3.2	87750/87111	1	513	726	91.2	55.7	203	215	271	256	266	3	14.3	3.6	3.2	0.42	1.44	0.79	9.67
	7.5000	317.500	12.5000	63.500	2.5000	63.500	2.5000	46.038	1.8125	4.3	3.2	93750/93125	1	757	1 130	122	71.4	205	227	306	278	294	7	17.5	4.3	3.2	0.52	1.15	0.63	19.3
	7.5000	317.500	12.5000	68.263	2.6875	63.500	2.5000	50.800	2.0000	4.3	3.2	93750/93126	1	757	1 130	122	76.2	205	227	306	276	294	2	17.5	4.3	3.2	0.52	1.15	0.63	20.3

[Note] 1) While metric series bearings have minus tolerances for bore and OD, inch series have plus tolerances. Refer to page 194 for details of applicable tolerance standards.

Single-row tapered roller bearings

d (190.500) ~ (203.200) mm

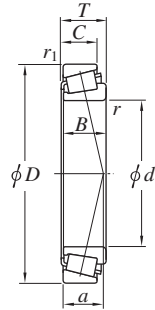

Design 1



Design 1-P

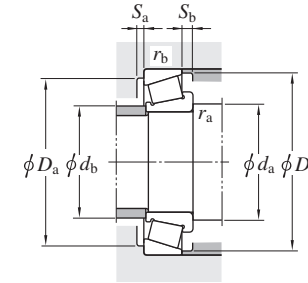

Boundary dimensions										Bearing No. ¹⁾	De- sign	Basic load ratings (kN)		Fatigue load limit (kN) <i>C_u</i>	Load center (mm) <i>a</i>	Mounting dimensions (mm)								Con- stant <i>e</i>	Axial load factors <i>Y₁</i> <i>Y₀</i>		(Refer.) Mass (kg)			
<i>d</i>	<i>D</i>		<i>T</i>		<i>B</i>		<i>C</i>		<i>r</i>			<i>r₁</i>	<i>C_r</i>			<i>C_{0r}</i>	<i>d_a</i>	<i>d_b</i>	<i>D_a</i>		<i>D_b</i>	<i>S_a</i>	<i>S_b</i>		<i>r_a</i>	<i>r_b</i>		<i>e</i>	<i>Y₁</i>	<i>Y₀</i>
mm	1/25.4	mm	1/25.4	mm	1/25.4	mm	1/25.4	mm	1/25.4	min.	min.			min.	max.	max.	min.	min.	min.	min.	max.	max.								
190.500	7.5000	336.550	13.2500	98.425	3.8750	95.250	3.7500	73.025	2.8750	6.4	6.4	HH840249/HH840210	1	1 200	1 710	177	93.5	209	217	318	288	316	8	25.4	6.4	6.4	0.58	1.04	0.57	35.8
	7.5000	368.300	14.5000	92.075	3.6250	88.897	3.4999	63.500	2.5000	6.4	3.2	EE420751/421450	1	1 180	1 460	159	75.6	209	243	356	317	334	6	28.6	6.4	3.2	0.40	1.49	0.82	40.4
	7.5000	428.625	16.8750	106.363	4.1875	95.250	3.7500	61.913	2.4375	6.4	6.4	EE350750/351687	1	1 340	1 390	145	118.7	209	238	410	350	381	9	44.5	6.4	6.4	0.76	0.79	0.44	62.0
193.675	7.6250	282.575	11.1250	50.800	2.0000	47.625	1.8750	36.512	1.4375	3.6	3.2	87762/87111	1	513	726	91.2	55.7	206	215	271	256	266	3	14.3	3.6	3.2	0.42	1.44	0.79	9.32
196.850	7.7500	254.000	10.0000	28.575	1.1250	27.783	1.0938	21.433	0.8438	1.6	1.6	L540049/L540010	1	236	387	48.2	43.1	206	214	245	238	243	4	7.1	1.6	1.6	0.40	1.51	0.83	3.35
	7.7500	257.175	10.1250	39.688	1.5625	39.688	1.5625	30.163	1.1875	3.6	3.2	LM739749/LM739710	1	336	632	78.6	50.6	210	211	245	238	247	6	9.5	3.6	3.2	0.45	1.34	0.74	5.27
	7.7500	266.700	10.5000	39.688	1.5625	39.688	1.5625	30.163	1.1875	3.6	3.2	LM739749/LM739719	1	336	632	78.6	50.6	210	211	255	238	247	6	9.5	3.6	3.2	0.45	1.34	0.74	6.18
	7.7500	317.500	12.5000	63.500	2.5000	63.500	2.5000	46.038	1.8125	4.3	3.2	93775/93125	1	757	1 130	122	71.4	211	227	306	278	294	7	17.5	4.3	3.2	0.52	1.15	0.63	18.4
	7.7500	317.500	12.5000	68.263	2.6875	63.500	2.5000	50.800	2.0000	4.3	3.2	93775/93126	1	757	1 130	122	76.2	211	227	306	276	294	2	17.5	4.3	3.2	0.52	1.15	0.63	19.3
200	—	280	—	51	—	51	—	39	—	3	2.5	32940JR	1	608	958	109	53.6	214	216	268	257	271	9	12	2.5	2	0.39	1.52	0.84	9.44
200.000	7.8740	300.000	11.8110	65.000	2.5591	62.000	2.4409	51.000	2.0079	3.6	2.5	JHM840449/JHM840410	1	773	1 140	124	72.1	213	218	290	270	288	6	14	3.6	2.5	0.52	1.15	0.63	15.0
200	—	310	—	70	—	70	—	53	—	3	2.5	32040JR	1	949	1 340	146	66.9	214	221	298	273	297	11	17	2.5	2	0.43	1.39	0.77	19.1
	—	360	—	64	—	58	—	48	—	5	4	30240JR	1	991	1 120	126	70.3	222	238	342	315	336	12	15	4	3	0.44	1.38	0.76	26.4
	—	360	—	104	—	98	—	82	—	5	4	32240JR	1	1 550	1 880	200	84.6	222	225	342	302	340	11	22	4	3	0.41	1.48	0.81	44.2
200.025	7.8750	276.225	10.8750	42.863	1.6875	46.038	1.8125	34.133	1.3438	3.6	3.2	LM241147/LM241110	1	469	715	89.7	46.3	214	222	263	257	264	4	8.7	3.6	3.2	0.32	1.88	1.04	7.57
	7.8750	292.100	11.5000	57.945	2.2813	57.945	2.2813	46.038	1.8125	3.6	3.2	M241543/M241510	1	683	1 030	115	52.6	214	223	279	267	277	7	11.9	3.6	3.2	0.33	1.80	0.99	12.1
	7.8750	317.500	12.5000	63.500	2.5000	63.500	2.5000	46.038	1.8125	4.3	3.2	93787/93125	1	757	1 130	122	71.4	215	227	305	278	294	7	17.5	4.3	3.2	0.52	1.15	0.63	17.9
	7.8750	355.600	14.0000	69.850	2.7500	69.850	2.7500	49.213	1.9375	6.7	1.6	EE130787/131400	1	913	1 310	140	59.9	220	263	346	319	330	9	20.6	6.7	1.6	0.33	1.82	1.00	28.7
	7.8750	384.175	15.1250	112.713	4.4375	112.712	4.4375	90.488	3.5625	6.4	6.4	H247535/H247510	1-P	1 820	2 680	271	83.8	219	265	365	341	361	8	22.2	6.4	6.4	0.33	1.80	0.99	60.5
	7.8750	393.700	15.5000	111.125	4.3750	111.125	4.3750	84.138	3.3125	6.4	6.4	HH144642/HH144614	1	1 710	2 260	236	76.2	219	257	374	338	355	9	27	6.4	6.4	0.30	2.02	1.11	59.2
203.200	8.0000	276.225	10.8750	42.863	1.6875	42.863	1.6875	34.133	1.3438	3.6	3.2	LM241149/LM241110	1	469	715	89.7	46.3	217	222	263	257	264	4	8.7	3.6	3.2	0.32	1.88	1.04	7.08
	8.0000	279.400	11.0000	46.038	1.8125	46.038	1.8125	36.513	1.4375	3.6	3.2	67983/67919	1	437	707	77.6	61.6	217	222	267	259	271	7	9.5	3.6	3.2	0.51	1.18	0.65	8.04
	8.0000	282.575	11.1250	46.038	1.8125	46.038	1.8125	36.513	1.4375	3.6	3.2	67983/67920	1	437	707	77.6	61.6	217	222	270	259	271	7	9.5	3.6	3.2	0.51	1.18	0.65	8.43
	8.0000	292.100	11.5000	57.945	2.2813	57.945	2.2813	46.038	1.8125	3.6	3.2	M241547/M241510	1	683	1 030	115	52.6	217	223	279	267	277	7	11.9	3.6	3.2	0.33	1.80	0.99	11.7

[Note] 1) While metric series bearings have minus tolerances for bore and OD, inch series have plus tolerances. Refer to page 194 for details of applicable tolerance standards.

Single-row tapered roller bearings

d (203.200) ~ 220.663 mm

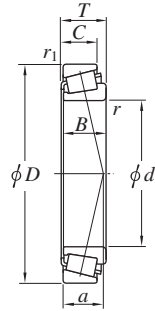

Design 1



Design 1-P

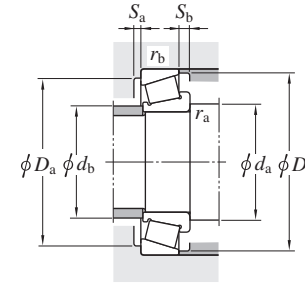

Boundary dimensions										Bearing No. ¹⁾	De- sign	Basic load ratings (kN)		Fatigue load limit (kN) <i>C_u</i>	Load center (mm) <i>a</i>	Mounting dimensions (mm)								Con- stant <i>e</i>	Axial load factors		(Refer.) Mass (kg)			
<i>d</i> mm	<i>D</i> mm		<i>T</i> mm		<i>B</i> mm		<i>C</i> mm		<i>r</i> min.			<i>r₁</i> min.	<i>C_r</i>			<i>C_{0r}</i>	<i>d_a</i> min.	<i>d_b</i> max.	<i>D_a</i> max.	<i>D_b</i> min.	<i>S_a</i> min.	<i>S_b</i> min.	<i>r_a</i> max.		<i>r_b</i> max.	<i>Y₁</i>		<i>Y₀</i>		
203.200	8.0000	317.500	12.5000	53.975	2.1250	53.975	2.1250	34.925	1.3750	4	3.2	EE132083/132125	1	550	724	83.2	48.4	218	238	305	285	292	7	19.1	4	3.2	0.31	1.91	1.05	13.9
	8.0000	317.500	12.5000	63.500	2.5000	63.500	2.5000	46.038	1.8125	4.3	3.2	93800/93125	1	757	1 130	122	71.4	218	227	305	278	294	7	17.5	4.3	3.2	0.52	1.15	0.63	17.4
	8.0000	317.500	12.5000	63.500	2.5000	63.500	2.5000	46.038	1.8125	7.9	3.2	93800A/93125	1	757	1 130	122	71.4	225	227	305	278	294	7	17.5	7.9	3.2	0.52	1.15	0.63	17.3
	8.0000	360.000	14.1732	92.075	3.6250	88.897	3.4999	63.500	2.5000	3.2	3.2	EE420801/421417	1	1 180	1 460	159	75.6	216	243	347	317	334	6	28.6	3.2	3.2	0.40	1.49	0.82	35.4
	8.0000	368.300	14.5000	92.075	3.6250	88.897	3.4999	63.500	2.5000	3.2	3.2	EE420801/421450	1	1 180	1 460	159	75.6	216	243	355	317	334	6	28.6	3.2	3.2	0.40	1.49	0.82	37.8
	8.0000	406.400	16.0000	92.075	3.6250	85.725	3.3750	57.150	2.2500	6.4	6.4	EE114080/114160	1	1 190	1 460	152	119.8	222	253	387	337	367	6	34.9	6.4	6.4	0.79	0.76	0.42	48.5
	8.0000	482.600	19.0000	117.475	4.6250	95.250	3.7500	73.025	2.8750	6.4	6.4	EE380080/380190	1-P	1 810	2 060	209	152.8	222	273	463	385	427	1	44.5	6.4	6.4	0.87	0.69	0.38	93.5
	203.987	8.0310	276.225	10.8750	42.863	1.6875	46.038	1.8125	34.132	1.3438	3.6	3.2	LM241148/LM241111	1	469	715	89.7	46.3	218	222	263	257	264	4	8.7	3.6	3.2	0.32	1.88	1.04
204.788	8.0625	292.100	11.5000	57.945	2.2813	57.945	2.2813	46.038	1.8125	3.6	3.2	M241549/M241510	1	683	1 030	115	52.6	218	223	279	267	277	7	11.9	3.6	3.2	0.33	1.80	0.99	11.5
206.375	8.1250	282.575	11.1250	46.038	1.8125	46.038	1.8125	36.513	1.4375	3.6	3.2	67985/67920	1	437	707	77.6	61.6	220	222	270	259	271	7	9.5	3.6	3.2	0.51	1.18	0.65	8.07
	8.1250	317.500	12.5000	53.975	2.1250	53.975	2.1250	34.925	1.3750	4	3.2	EE132084/132125	1	550	724	83.2	48.4	221	238	305	285	292	7	19.1	4	3.2	0.31	1.91	1.05	13.4
	8.1250	319.088	12.5625	53.975	2.1250	53.975	2.1250	34.925	1.3750	4	3.2	EE132084/132127	1	550	724	83.2	48.4	221	238	306	285	292	7	19.1	4	3.2	0.31	1.91	1.05	13.6
	8.1250	336.550	13.2500	98.425	3.8750	100.013	3.9375	77.788	3.0625	3.2	3.2	H242649/H242610	1	758	1 900	115	73.8	219	236	324	300	317	9	20.6	3.2	3.2	0.33	1.80	0.99	33.1
209.550	8.2500	317.500	12.5000	63.500	2.5000	63.500	2.5000	46.038	1.8125	4.3	3.2	93825/93125	1	757	1 130	122	71.4	225	227	305	278	294	7	17.5	4.3	3.2	0.52	1.15	0.63	16.4
	8.2500	317.500	12.5000	63.500	2.5000	63.500	2.5000	46.038	1.8125	12.7	3.2	93825A/93125	1	757	1 130	122	71.4	241	227	305	278	294	7	17.5	12.7	3.2	0.52	1.15	0.63	16.2
	8.2500	333.375	13.1250	69.850	2.7500	69.850	2.7500	52.388	2.0625	6.4	6.4	HM743345/HM743310	1	942	1 330	144	71.9	229	243	314	301	316	7	17.5	6.4	6.4	0.44	1.37	0.75	22.2
	8.2500	355.600	14.0000	68.263	2.6875	66.675	2.6250	47.625	1.8750	7.1	3.2	96825/96140	1	823	1 320	139	84.9	230	259	343	312	331	8	20.6	7.1	3.2	0.59	1.02	0.56	26.9
215.900	8.5000	288.925	11.3750	46.038	1.8125	46.038	1.8125	34.925	1.3750	3.6	3.2	LM742749/LM742714	1	447	781	95.2	60.7	230	232	276	265	276	6	11.1	3.6	3.2	0.48	1.25	0.69	7.94
	8.5000	360.000	14.1732	82.550	3.2500	79.372	3.1249	63.500	2.5000	1.6	3.2	EE420850/421417	1	1 180	1 460	159	75.7	226	243	347	317	334	6	19.1	1.6	3.2	0.40	1.49	0.82	30.9
220	—	300	—	51	—	51	—	39	—	3	2.5	32944JR	1	621	1 010	112	58.6	234	234	288	275	290	9	12	2.5	2	0.43	1.41	0.78	10.1
	—	340	—	76	—	76	—	57	—	4	3	32044JR	1	1 120	1 620	175	72.8	238	243	326	300	326	12	19	3	2.5	0.43	1.39	0.77	25.2
	—	400	—	72	—	65	—	54	—	5	4	30244JR	1	1 260	1 440	160	76.5	242	263	382	344	371	14	17	4	3	0.44	1.43	0.79	35.9
220.663	8.6875	314.325	12.3750	61.913	2.4375	61.913	2.4375	49.213	1.9375	6.4	3.2	M244249/M244210	1	768	1 220	135	58.0	240	243	301	288	299	5	12.7	6.4	3.2	0.33	1.80	0.99	14.5

[Note] 1) While metric series bearings have minus tolerances for bore and OD, inch series have plus tolerances. Refer to page 194 for details of applicable tolerance standards.

Single-row tapered roller bearings

d 220.878 ~ 240 mm

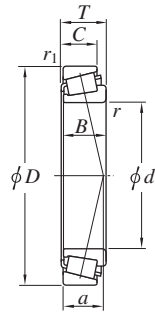

Design 1



Design 1-P

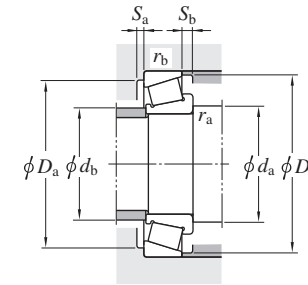

Boundary dimensions										Bearing No. ¹⁾	De- sign	Basic load ratings (kN)		Fatigue load limit (kN) C_u	Load center (mm) a	Mounting dimensions (mm)								Con- stant e	Axial load factors Y_1 Y_0		(Refer.) Mass (kg)			
d mm	D mm	T mm	B mm	C mm	r min.	r_1 min.	C_r	C_{Or}	d_a min.			d_b max.	D_a max.			D_b min.	S_a min.	S_b min.	r_a max.	r_b max.	e	Y_1	Y_0							
220.878	8.6960	317.500	12.5000	47.625	1.8750	52.388	2.0625	36.513	1.4375	3.2	3.2	LM245833/LM245810	1	611	928	103	50.5	234	253	305	296	304	8	11.1	3.2	3.2	0.33	1.80	0.99	12.3
223.838	8.8125	295.275	11.6250	46.038	1.8125	46.038	1.8125	34.925	1.3750	3.6	3.2	LM844049/LM844010	1	451	792	95.6	63.1	237	239	282	273	285	6	11.1	3.6	3.2	0.50	1.20	0.66	8.01
225.425	8.8750	355.600	14.0000	69.850	2.7500	69.850	2.7500	49.213	1.9375	6.7	1.6	EE130889/131400	1	913	1310	140	59.9	245	263	346	319	330	9	20.6	6.7	1.6	0.33	1.82	1.00	24.1
	8.8750	400.050	15.7500	88.900	3.5000	87.313	3.4375	63.500	2.5000	1.6	3.2	EE430888/431575	1	1240	1600	169	82.6	235	267	387	344	363	8	25.4	1.6	3.2	0.44	1.37	0.75	42.5
228.600	9.0000	355.600	14.0000	68.263	2.6875	66.675	2.6250	47.625	1.8750	7.1	3.2	96900/96140	1	823	1320	139	84.9	249	259	343	312	331	8	20.6	7.1	3.2	0.59	1.02	0.56	23.5
	9.0000	355.600	14.0000	69.850	2.7500	69.850	2.7500	49.213	1.9375	6.7	1.6	EE130902/131400	1	913	1310	140	59.9	248	263	346	319	330	9	20.6	6.7	1.6	0.33	1.82	1.00	23.5
	9.0000	355.600	14.0000	69.850	2.7500	69.850	2.7500	50.800	2.0000	6.4	6.4	HM746646/HM746610	1	969	1370	148	77.0	248	261	336	322	338	8	19.1	6.4	6.4	0.47	1.27	0.70	24.0
	9.0000	358.775	14.1250	71.438	2.8125	71.438	2.8125	53.975	2.1250	3.6	3.2	M249732/M249710	1	968	1590	166	64.4	242	279	346	330	342	8	17.5	3.6	3.2	0.33	1.80	0.99	26.6
	9.0000	400.050	15.7500	88.900	3.5000	87.313	3.4375	63.500	2.5000	10.4	3.2	EE430900/431575	1	1240	1600	169	82.6	256	267	387	344	363	8	25.4	10.4	3.2	0.44	1.37	0.75	41.6
	9.0000	425.450	16.7500	101.600	4.0000	95.250	3.7500	76.200	3.0000	7.1	6.4	EE700091/700167	1	1480	1980	205	81.1	249	285	406	364	381	6	25.4	7.1	6.4	0.33	1.80	0.99	58.7
	9.0000	508.000	20.0000	117.475	4.6250	95.250	3.7500	73.025	2.8750	6.4	6.4	EE390090/390200	1	1550	1800	178	168.1	248	303	489	410	455	1	44.5	6.4	6.4	0.94	0.64	0.35	97.1
231.775	9.1250	295.275	11.6250	33.338	1.3125	31.750	1.2500	23.813	0.9375	3.6	3.2	544091/544116	1	307	491	59.4	50.1	245	248	282	277	283	4	9.5	3.6	3.2	0.40	1.49	0.82	4.84
	9.1250	300.038	11.8125	33.338	1.3125	31.750	1.2500	23.813	0.9375	3.6	3.2	544091/544118	1	307	491	59.4	50.1	245	248	287	277	283	4	9.5	3.6	3.2	0.40	1.49	0.82	5.25
	9.1250	377.825	14.8750	79.375	3.1250	80.963	3.1875	58.738	2.3125	3.2	3.2	HM647448/HM647411	1	1210	1630	172	77.6	245	266	365	336	353	10	20.6	3.2	3.2	0.43	1.40	0.77	32.9
234.950	9.2500	314.325	12.3750	49.213	1.9375	49.213	1.9375	36.513	1.4375	3.6	3.2	LM545849/LM545810	1	606	981	106	57.5	249	253	301	293	303	9	12.7	3.6	3.2	0.40	1.51	0.83	10.2
	9.2500	317.500	12.5000	49.213	1.9375	49.213	1.9375	36.513	1.4375	3.6	3.2	LM545849/LM545812	1	606	981	106	57.5	249	253	305	293	303	9	12.7	3.6	3.2	0.40	1.51	0.83	10.6
	9.2500	327.025	12.8750	52.388	2.0625	52.388	2.0625	36.513	1.4375	6.4	3.2	8575/8520	1	584	930	100	60.0	254	259	314	299	309	7	15.9	6.4	3.2	0.41	1.48	0.81	12.2
	9.2500	328.625	12.9380	52.388	2.0625	52.388	2.0625	36.513	1.4375	6.4	3.2	8575/8522	1	584	930	100	60.0	254	259	316	299	309	7	15.9	6.4	3.2	0.41	1.48	0.81	12.4
	9.2500	381.000	15.0000	74.613	2.9375	74.613	2.9375	57.150	2.2500	6.4	3.2	M252330/M252310	1	1070	1670	174	69.0	254	295	368	350	363	6	17.5	6.4	3.2	0.33	1.80	0.99	32.5
	9.2500	384.175	15.1250	112.713	4.4375	112.712	4.4375	90.488	3.5625	6.4	6.4	H247549/H247510	1-P	1820	2680	271	83.8	254	265	365	341	361	8	22.2	6.4	6.4	0.33	1.80	0.99	50.0
237.330	9.3437	336.550	13.2500	65.088	2.5625	65.088	2.5625	50.800	2.0000	6.4	3.2	M246949/M246910	1	887	1380	150	59.9	257	259	324	309	320	8	14.3	6.4	3.2	0.33	1.80	0.99	17.1
	9.3437	358.775	14.1250	71.438	2.8125	71.438	2.8125	53.975	2.1250	6.4	3.2	M249736/M249710	1	968	1590	166	64.4	257	279	346	330	342	8	17.5	6.4	3.2	0.33	1.80	0.99	24.8
240	—	320	—	51	—	51	—	39	—	3	2.5	32948JR	1	645	1090	119	64.5	254	254	308	294	311	9	12	2.5	2	0.46	1.31	0.72	10.9
	—	360	—	76	—	76	—	57	—	4	3	32048JR	1	1160	1720	180	78.5	258	261	346	318	346	12	19	3	2.5	0.46	1.31	0.72	26.8

[Note] 1) While metric series bearings have minus tolerances for bore and OD, inch series have plus tolerances. Refer to page 194 for details of applicable tolerance standards.

Single-row tapered roller bearings

d 241.300 ~ 255.600 mm

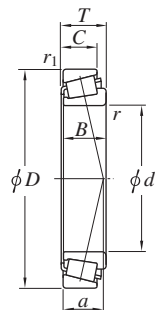

Design 1



Design 1-P

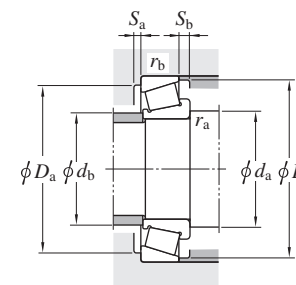

Boundary dimensions										Bearing No. ¹⁾	De- sign	Basic load ratings (kN)		Fatigue load limit (kN) <i>C_u</i>	Load center (mm) <i>a</i>	Mounting dimensions (mm)								Con- stant <i>e</i>	Axial load factors		(Refer.) Mass (kg)				
<i>d</i>	<i>D</i>		<i>T</i>		<i>B</i>		<i>C</i>		<i>r</i>			<i>r₁</i>	<i>C_r</i>			<i>C_{0r}</i>	<i>d_a</i>	<i>d_b</i>	<i>D_a</i>		<i>D_b</i>		<i>S_a</i>		<i>S_b</i>	<i>r_a</i>		<i>r_b</i>	<i>Y₁</i>	<i>Y₀</i>	
mm	1/25.4	mm	1/25.4	mm	1/25.4	mm	1/25.4	mm	1/25.4	min.	min.			min.	max.	max.	min.	min.	min.	min.	max.	max.									
241.300	9.5000	327.025	12.8750	52.388	2.0625	52.388	2.0625	36.513	1.4375	6.4	3.2	8578/8520	1	584	930	100	60.0	261	259	314	299	309	7	15.9	6.4	3.2	0.41	1.48	0.81	11.2	
	9.5000	444.500	17.5000	101.600	4.0000	100.013	3.9375	76.200	3.0000	6.4	4.8	EE923095/923175	1	1 610	1 980	204	84.4	261	298	428	389	406	7	25.4	6.4	4.8	0.34	1.78	0.98	62.1	
	9.5000	488.950	19.2500	120.650	4.7500	120.650	4.7500	92.075	3.6250	6.4	6.4	EE295950/295193	1	2 100	2 790	276	92.7	261	328	470	427	446	8	28.6	6.4	6.4	0.31	1.94	1.07	100	
	9.5000	508.000	20.0000	117.475	4.6250	95.250	3.7500	73.025	2.8750	6.4	6.4	EE390095/390200	1	1 550	1 800	178	168.1	261	303	489	410	455	1	44.5	6.4	6.4	0.94	0.64	0.35	93.7	
243.683	9.5938	315.913	12.4375	31.750	1.2500	31.750	1.2500	22.225	0.8750	3.6	3.2	LL648434/LL648415	1	303	549	64.6	54.0	257	268	303	295	301	6	9.5	3.6	3.2	0.43	1.39	0.77	6.00	
244.475	9.6250	381.000	15.0000	79.375	3.1250	76.200	3.0000	57.150	2.2500	6.4	4.8	EE126097/126150	1	988	1 470	153	88.5	264	276	365	336	356	5	22.2	6.4	4.8	0.52	1.16	0.64	30.6	
247.650	9.7500	304.800	12.0000	22.225	0.8750	22.225	0.8750	15.875	0.6250	1.6	1.6	28880/28820	1	195	322	37.8	38.8	257	262	295	285	288	6	6.4	1.6	1.6	0.32	1.85	1.02	3.05	
	9.7500	346.075	13.6250	63.500	2.5000	63.500	2.5000	50.800	2.0000	6.4	6.4	M348449/M348410	1	909	1 440	154	61.7	267	268	327	319	330	9	12.7	6.4	6.4	0.34	1.75	0.96	17.4	
	9.7500	355.600	14.0000	50.800	2.0000	50.800	2.0000	33.338	1.3125	6.4	3.2	EE170975/171400	1	635	924	102	56.1	267	280	343	327	335	10	17.5	6.4	3.2	0.36	1.65	0.91	15.1	
	9.7500	368.300	14.5000	50.800	2.0000	50.800	2.0000	33.338	1.3125	6.4	3.2	EE170975/171450	1	635	924	102	56.1	267	280	355	327	335	10	17.5	6.4	3.2	0.36	1.65	0.91	17.0	
	9.7500	381.000	15.0000	74.613	2.9375	74.613	2.9375	57.150	2.2500	6.4	3.2	M252337/M252310	1	1 070	1 670	174	69.0	267	295	368	350	363	6	17.5	6.4	3.2	0.33	1.80	0.99	29.7	
	9.7500	406.400	16.0000	115.888	4.5625	117.475	4.6250	93.663	3.6875	6.4	6.4	HH249949/HH249910	1-P	2 040	3 120	306	86.3	267	282	387	361	382	11	22.2	6.4	6.4	0.33	1.80	0.99	58.6	
	9.7500	444.500	17.5000	104.775	4.1250	103.188	4.0625	76.200	3.0000	6.4	4.8	EE115097/115175	1	1 950	2 460	255	85.3	267	296	428	394	412	10	28.6	6.4	4.8	0.35	1.73	0.95	65.0	
249.250	9.8130	381.000	15.0000	79.375	3.1250	76.200	3.0000	57.150	2.2500	6.4	4.8	EE126098/126150	1	988	1 470	153	88.5	269	276	365	336	356	5	22.2	6.4	4.8	0.52	1.16	0.64	29.5	
	254.000	10.0000	315.913	12.4375	31.750	1.2500	31.750	1.2500	22.225	0.8750	3.6	4.8	LL648449/LL648416	1	303	549	64.6	54.0	268	268	300	295	301	6	9.5	3.6	4.8	0.43	1.39	0.77	4.99
		10.0000	358.775	14.1250	71.438	2.8125	71.438	2.8125	53.975	2.1250	3.6	3.2	M249749/M249710	1	968	1 590	166	64.4	268	279	346	330	342	8	17.5	3.6	3.2	0.33	1.80	0.99	21.3
		10.0000	365.125	14.3750	58.738	2.3125	58.738	2.3125	42.863	1.6875	6.4	6.4	EE134100/134143	1	708	1 070	116	63.7	273	286	346	334	345	8	15.9	6.4	6.4	0.37	1.60	0.88	18.2
	10.0000	368.300	14.5000	58.738	2.3125	58.738	2.3125	42.863	1.6875	6.4	6.4	EE134100/134145	1	708	1 070	116	63.7	273	286	349	334	345	8	15.9	6.4	6.4	0.37	1.60	0.88	18.8	
	10.0000	393.700	15.5000	73.817	2.9062	69.850	2.7500	50.005	1.9687	6.4	6.4	EE275100/275155	1	921	1 540	157	75.4	273	314	374	364	377	5	23.8	6.4	6.4	0.40	1.49	0.82	31.1	
	10.0000	403.225	15.8750	69.850	2.7500	69.850	2.7500	46.038	1.8125	6.4	6.4	EE275100/275158	1	921	1 540	157	71.5	273	314	384	365	377	9	23.8	6.4	6.4	0.40	1.49	0.82	32.5	
	10.0000	422.275	16.6250	86.121	3.3906	79.771	3.1406	66.675	2.6250	6.7	3.2	HM252343/HM252310	1	1 270	1 680	177	78.7	274	309	409	384	399	1	19.4	6.7	3.2	0.33	1.80	0.99	42.7	
	10.0000	495.300	19.5000	141.288	5.5625	141.288	5.5625	114.300	4.5000	6.4	6.4	HH258232/HH258210	1-P	2 930	4 670	429	108.1	273	346	476	441	467	8	27	6.4	6.4	0.33	1.80	0.99	128	
	10.0000	533.400	21.0000	133.350	5.2500	120.650	4.7500	77.788	3.0625	6.4	6.4	HH953749/HH953710	1-P	2 230	2 800	262	180.8	273	324	510	446	495	4	55.6	6.4	6.4	0.94	0.64	0.35	127	
255.600	10.0630	342.900	13.5000	57.150	2.2500	63.500	2.5000	44.450	1.7500	1.6	3.2	M349547/M349510	1	764	1 280	135	60.1	265	276	330	320	330	6	12.7	1.6	3.2	0.35	1.73	0.95	14.1	

[Note] 1) While metric series bearings have minus tolerances for bore and OD, inch series have plus tolerances. Refer to page 194 for details of applicable tolerance standards.

Single-row tapered roller bearings

d 257.175 ~ (285.750) mm

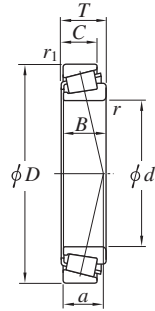

Design 1



Design 1-P

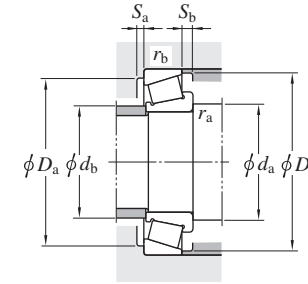

Boundary dimensions										Bearing No. ¹⁾	De- sign	Basic load ratings (kN)		Fatigue load limit (kN) C_u	Load center (mm) a	Mounting dimensions (mm)								Con- stant e	Axial load factors Y_1 Y_0		(Refer.) Mass (kg)			
d mm	D mm	T mm	B mm	C mm	r min.	r_1 min.	C_r	C_{Or}	d_a min.			d_b max.	D_a max.			D_b min.	S_a min.	S_b min.	r_a max.	r_b max.	e	Y_1	Y_0							
257.175	10.1250	342.900	13.5000	57.150	2.2500	57.150	2.2500	44.450	1.7500	6.4	3.2	M349549/M349510	1	764	1 280	135	60.1	276	276	330	320	330	6	12.7	6.4	3.2	0.35	1.73	0.95	13.3
	10.1250	358.775	14.1250	71.438	2.8125	76.200	3.0000	53.975	2.1250	1.6	3.2	M249747/M249710	1	968	1 590	166	64.4	267	279	346	330	342	8	17.5	1.6	3.2	0.33	1.80	0.99	21
258.763	10.1875	400.050	15.7500	69.850	2.7500	67.470	2.6563	46.038	1.8125	9.5	6.4	EE221018/221575	1	953	1 280	137	71.2	284	295	381	359	371	6	23.8	9.5	6.4	0.39	1.52	0.84	26.7
260	—	360	—	63.5	—	63.5	—	48	—	3	2.5	32952JR	1	926	1 550	163	69.6	274	279	348	328	347	11	15.5	2.5	2	0.41	1.48	0.81	18.9
	—	400	—	87	—	87	—	65	—	5	4	32052JR	1	1 470	2 170	221	85.0	282	287	382	352	383	14	22	4	3	0.43	1.38	0.76	39.5
260.350	10.2500	365.125	14.3750	58.738	2.3125	58.738	2.3125	42.863	1.6875	6.4	6.4	EE134102/134143	1	708	1 070	116	63.7	280	286	346	334	345	8	15.9	6.4	6.4	0.37	1.60	0.88	17.1
	10.2500	419.100	16.5000	85.725	3.3750	84.138	3.3125	61.913	2.4375	6.4	3.2	EE435102/435165	1	1 230	1 760	181	106.0	280	296	406	369	394	6	23.8	6.4	3.2	0.60	0.99	0.55	42.3
	10.2500	422.275	16.6250	86.121	3.3906	79.771	3.1406	66.675	2.6250	6.7	3.2	HM252348/HM252310	1	1 270	1 680	177	78.7	280	309	409	384	399	1	19.4	6.7	3.2	0.33	1.80	0.99	41.2
263.525	10.3750	325.438	12.8125	28.575	1.1250	28.575	1.1250	25.400	1.0000	1.6	1.6	38880/38820	1	272	507	58.8	48.6	273	281	316	306	312	6	3.2	1.6	1.6	0.37	1.64	0.90	5.08
264.975	10.4321	355.600	14.0000	57.150	2.2500	62.000	2.4409	44.450	1.7500	3.6	3.2	LM451347/LM451310	1	757	1 280	134	62.3	279	287	343	332	342	8	12.7	3.6	3.2	0.36	1.67	0.92	15.3
266.700	10.5000	325.438	12.8125	28.575	1.1250	28.575	1.1250	25.400	1.0000	1.6	1.6	38885/38820	1	272	507	58.8	48.6	276	281	316	306	312	6	3.2	1.6	1.6	0.37	1.64	0.90	4.79
	10.5000	355.600	14.0000	57.150	2.2500	57.150	2.2500	44.450	1.7500	3.6	3.2	LM451349/LM451310	1	757	1 280	134	62.3	280	287	343	332	342	8	12.7	3.6	3.2	0.36	1.67	0.92	14.7
	10.5000	393.700	15.5000	73.817	2.9062	69.850	2.7500	50.005	1.9687	6.4	6.4	EE275105/275155	1	921	1 540	157	75.4	286	314	374	364	377	5	23.8	6.4	6.4	0.40	1.49	0.82	28.3
	10.5000	444.500	17.5000	120.650	4.7500	117.475	4.6250	88.900	3.5000	6.4	6.4	H852849/H852810	1	1 890	2 820	266	121.3	286	300	425	390	424	9	31.8	6.4	6.4	0.58	1.04	0.57	71.2
269.875	10.6250	381.000	15.0000	74.613	2.9375	74.613	2.9375	57.150	2.2500	6.4	3.2	M252349/M252310	1	1 070	1 670	174	69.0	289	295	368	350	363	6	17.5	6.4	3.2	0.33	1.80	0.99	24.5
276.225	10.8750	352.425	13.8750	36.513	1.4375	34.925	1.3750	23.813	0.9375	3.6	3.2	L853049/L853010	1	389	653	75.2	71.2	290	295	340	329	337	7	12.7	3.6	3.2	0.54	1.11	0.61	7.53
279.400	11.0000	469.900	18.5000	95.250	3.7500	93.663	3.6875	69.850	2.7500	9.5	3.2	EE722110/722185	1	1 540	2 190	219	87.2	305	332	457	412	430	7	25.4	9.5	3.2	0.38	1.59	0.88	60.7
	11.0000	488.950	19.2500	120.650	4.7500	120.650	4.7500	92.075	3.6250	1.2	6.4	EE295110/295193	1	2 100	2 790	276	92.7	288	328	470	427	446	8	28.6	1.2	6.4	0.31	1.94	1.07	85.5
280	—	380	—	63.5	—	63.5	—	48	—	3	2.5	32956JR	1	949	1 630	168	75.1	294	298	368	347	368	11	15.5	2.5	2	0.43	1.39	0.76	20.1
	—	420	—	87	—	87	—	65	—	5	4	32056JR	1	1 510	2 280	230	91.1	302	305	402	370	402	14	22	4	3	0.46	1.31	0.72	41.7
285.750	11.2500	358.775	14.1250	33.338	1.3125	31.750	1.2500	22.225	0.8750	3.6	3.2	545112/545141	1	301	537	60.9	65.8	299	308	346	337	344	6	11.1	3.6	3.2	0.49	1.23	0.68	6.75

[Note] 1) While metric series bearings have minus tolerances for bore and OD, inch series have plus tolerances. Refer to page 194 for details of applicable tolerance standards.

Single-row tapered roller bearings

d (285.750) ~ 340 mm

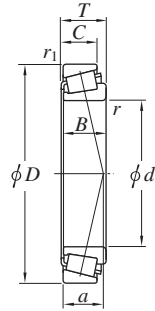

Design 1



Design 1-P

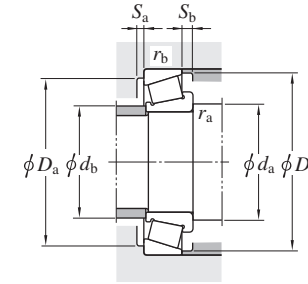

Boundary dimensions										Bearing No. ¹⁾	De- sign	Basic load ratings (kN)		Fatigue load limit (kN) <i>C_u</i>	Load center (mm) <i>a</i>	Mounting dimensions (mm)								Con- stant <i>e</i>	Axial load factors <i>Y₁</i> <i>Y₀</i>		(Refer.) Mass (kg)
<i>d</i> mm	<i>D</i> mm	<i>T</i> mm	<i>B</i> mm	<i>C</i> mm	<i>r</i> min.	<i>r₁</i> min.	<i>C_r</i>	<i>C_{0r}</i>	<i>d_a</i> min.			<i>d_b</i> max.	<i>D_a</i> max.			<i>D_b</i> min.	<i>S_a</i> min.	<i>S_b</i> min.	<i>r_a</i> max.	<i>r_b</i> max.	<i>Y₁</i>	<i>Y₀</i>					
285.750	11.2500 380.898	14.9960 65.088	2.5625 65.088	2.5625 49.213	1.9375 3.6	3.2	LM654649/LM654610	1	831	1 410	143	75.9	299	307	368	356	370	7	15.9	3.6	3.2	0.43	1.39	0.77	18.9		
288.925	11.3750 406.400	16.0000 77.788	3.0625 77.788	3.0625 60.325	2.3750 6.4	3.2	M255449/M255410	1	1 260	2 210	223	73.2	308	318	394	373	387	8	17.5	6.4	3.2	0.34	1.77	0.98	30.9		
292.100	11.5000 374.650	14.7500 47.625	1.8750 47.625	1.8750 34.925	1.3750 3.6	3.2	L555249/L555210	1	587	971	111	64.7	306	309	362	351	360	8	12.7	3.6	3.2	0.40	1.49	0.82	11.5		
298.450	11.7500 444.500	17.5000 63.500	2.5000 61.913	2.4375 39.688	1.5625 7.9	1.6	EE291175/291750	1	902	1 380	144	70.0	321	346	435	403	413	11	23.8	7.9	1.6	0.38	1.59	0.87	30.4		
300	— 420	— 76	— 76	— 57	— 4	3	32960JR	1	1 320	2 210	223	79.9	318	324	406	383	405	12	19	3	2.5	0.39	1.52	0.84	32.4		
	— 460	— 100	— 100	— 74	— 5	4	32060JR	1	1 800	2 660	263	97.9	322	329	442	404	439	15	26	4	3	0.43	1.38	0.76	57.5		
300.038	11.8125 422.275	16.6250 82.550	3.2500 82.550	3.2500 63.500	2.5000 6.4	3.2	HM256849/HM256810	1	1 240	2 010	204	76.4	320	328	408	388	402	7	19.1	6.4	3.2	0.34	1.78	0.98	33.6		
304.800	12.0000 393.700	15.5000 50.800	2.0000 50.800	2.0000 38.100	1.5000 6.4	3.2	L357049/L357010	1	658	1 180	133	64.8	325	329	380	369	378	5	12.7	6.4	3.2	0.36	1.67	0.92	14.6		
	12.0000 406.400	16.0000 63.500	2.5000 63.500	2.5000 47.625	1.8750 6.4	3.2	LM757049/LM757010	1	935	1 580	159	79.6	325	324	393	376	390	8	15.9	6.4	3.2	0.44	1.36	0.75	21.2		
	12.0000 444.500	17.5000 63.500	2.5000 61.913	2.4375 39.688	1.5625 7.9	1.6	EE291201/291750	1	902	1 380	144	70.0	328	346	434	403	413	11	23.8	7.9	1.6	0.38	1.59	0.87	29.0		
	12.0000 495.300	19.5000 95.250	3.7500 92.075	3.6250 69.850	2.7500 16	6.4	EE724120/724195	1	1 600	2 340	231	95.2	344	359	475	438	457	6	25.4	16	6.4	0.40	1.49	0.82	64.8		
317.500	12.5000 444.500	17.5000 63.500	2.5000 61.913	2.4375 39.688	1.5625 7.9	1.6	EE291250/291750	1	902	1 380	144	70.0	341	346	434	403	413	11	23.8	7.9	1.6	0.38	1.59	0.87	26.0		
	12.5000 447.675	17.6250 85.725	3.3750 85.725	3.3750 68.263	2.6875 3.6	3.2	HM259049/HM259010	1	1 400	2 390	233	80.8	332	346	434	410	427	8	17.5	3.6	3.2	0.33	1.79	0.99	40.2		
	12.5000 622.300	24.5000 147.638	5.8125 131.763	5.1875 82.550	3.2500 14.3	12.7	H961649/H961610	1-P	2 790	3 490	316	210.5	354	390	585	530	580	7	65.1	14.3	12.7	0.94	0.64	0.35	179		
320	— 440	— 76	— 76	— 57	— 4	3	32964JR	1	1 330	2 270	226	85.0	338	342	426	401	426	12	19	3	2.5	0.42	1.44	0.79	34.0		
	— 480	— 100	— 100	— 74	— 5	4	32064JR	1	1 900	2 810	273	103.0	342	344	462	418	461	16	26	4	3	0.46	1.31	0.72	58.7		
323.850	12.7500 381.000	15.0000 28.575	1.1250 28.575	1.1250 20.638	0.8125 3.6	3.3	LL758744/LL758715	1	275	570	62.5	64.8	339	340	367	363	369	5	7.9	3.6	3.3	0.44	1.36	0.75	5.15		
330.200	13.0000 415.925	16.3750 47.625	1.8750 47.625	1.8750 34.925	1.3750 3.6	3.2	L860049/L860010	1	568	1 080	119	82.8	345	351	402	389	401	6	12.7	3.6	3.2	0.50	1.20	0.66	13.8		
333.375	13.1250 469.900	18.5000 90.488	3.5625 90.488	3.5625 71.438	2.8125 6.4	3.2	HM261049/HM261010	1	1 520	2 580	249	84.3	354	365	456	430	446	8	19.1	6.4	3.2	0.33	1.79	0.99	46.2		
340	— 460	— 76	— 76	— 57	— 4	3	32968JR	1	1 340	2 340	229	90.5	358	361	446	420	446	12	19	3	2.5	0.44	1.37	0.75	35.6		

[Note] 1) While metric series bearings have minus tolerances for bore and OD, inch series have plus tolerances. Refer to page 194 for details of applicable tolerance standards.

Single-row tapered roller bearings

d 342.900 ~ (381.000) mm

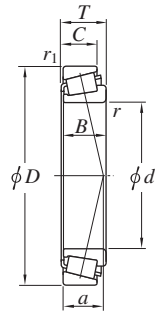

Design 1



Design 1-P

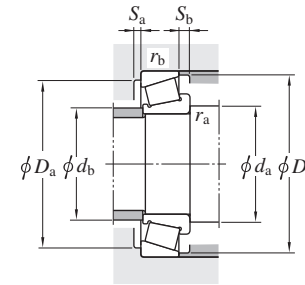

Boundary dimensions										Bearing No. 1)	De- sign	Basic load ratings (kN)		Fatigue load limit (kN) Cu	Load center (mm) a	Mounting dimensions (mm)								Con- stant e	Axial load factors		(Refer.) Mass (kg)			
d	D		T		B		C		r			r1	Cr			Cor	da	db	Da		Db		Sa		Sb	ra		rb	Y1	Y0
mm	1/25.4	mm	1/25.4	mm	1/25.4	mm	1/25.4	mm	1/25.4	min.	min.			min.	max.	max.	min.	min.	min.	min.	max.	max.								
342.900	13.5000	450.850	17.7500	66.675	2.6250	66.675	2.6250	52.388	2.0625	8.5	3.6	LM361649/LM361610	1	1 060	1 980	195	76.2	367	370	436	420	433	9	14.3	8.5	3.6	0.35	1.70	0.94	27.8
	13.5000	457.098	17.9960	66.675	2.6250	63.500	2.5000	46.038	1.8125	3.2	3.2	LM961548/LM961510	1	914	1 670	159	122.3	357	366	443	420	442	8	20.6	3.2	3.2	0.71	0.84	0.46	28.2
	13.5000	533.400	21.0000	76.200	3.0000	76.200	3.0000	50.800	2.0000	4.8	3.2	EE971354/972100	1	1 370	1 790	181	79.4	360	397	520	482	493	8	25.4	4.8	3.2	0.33	1.80	0.99	53.8
346.075	13.6250	482.600	19.0000	60.325	2.3750	55.563	2.1875	38.100	1.5000	7.1	6.4	EE161363/161900	1	769	1 250	124	93.7	368	388	462	440	453	7	22.2	7.1	6.4	0.50	1.20	0.66	29.4
	13.6250	482.600	19.0000	66.675	2.6250	63.500	2.5000	44.450	1.7500	6.7	6.7	EE203136/203190	1	906	1 430	144	86.6	367	386	462	442	454	6	22.2	6.7	6.7	0.42	1.44	0.79	32.4
	13.6250	488.950	19.2500	95.250	3.7500	95.250	3.7500	74.613	2.9375	6.4	3.2	HM262749/HM262710	1	1 690	2 900	276	88.5	366	382	475	450	466	8	20.6	6.4	3.2	0.33	1.79	0.99	53.3
349.250	13.7500	501.650	19.7500	90.488	3.5625	84.138	3.3125	69.850	2.7500	6.4	3.2	EE333137/333197	1	1 600	2 550	250	95.2	370	391	488	465	482	7	20.6	6.4	3.2	0.37	1.60	0.88	53.0
354.013	13.9375	469.900	18.5000	60.325	2.3750	55.563	2.1875	38.100	1.5000	7.1	6.4	EE161394/161850	1	769	1 250	124	93.7	376	388	450	440	453	7	22.2	7.1	6.4	0.50	1.20	0.66	24.7
	13.9375	488.950	19.2500	60.325	2.3750	55.563	2.1875	38.100	1.5000	7.1	6.4	EE161394/161925	1	769	1 250	124	93.7	376	388	469	440	453	7	22.2	7.1	6.4	0.50	1.20	0.66	28.9
355.600	14.0000	444.500	17.5000	60.325	2.3750	60.325	2.3750	47.625	1.8750	3.6	3.2	L163149/L163110	1	811	1 720	166	67.0	370	379	431	417	427	8	12.7	3.6	3.2	0.31	1.95	1.07	20.3
	14.0000	469.900	18.5000	60.325	2.3750	55.563	2.1875	38.100	1.5000	7.1	6.4	EE161400/161850	1	769	1 250	124	93.7	377	388	450	440	453	7	22.2	7.1	6.4	0.50	1.20	0.66	24.3
	14.0000	482.600	19.0000	60.325	2.3750	55.563	2.1875	38.100	1.5000	7.1	6.4	EE161400/161900	1	769	1 250	124	93.7	377	388	462	440	453	7	22.2	7.1	6.4	0.50	1.20	0.66	27.1
	14.0000	488.950	19.2500	60.325	2.3750	55.563	2.1875	38.100	1.5000	7.1	6.4	EE161400/161925	1	769	1 250	124	93.7	377	388	469	440	453	7	22.2	7.1	6.4	0.50	1.20	0.66	28.5
	14.0000	501.650	19.7500	74.613	2.9375	66.675	2.6250	50.800	2.0000	6.4	3.2	EE231400/231975	1	989	1 640	161	97.3	376	409	488	465	480	2	23.8	6.4	3.2	0.44	1.36	0.75	40.5
	14.0000	501.650	19.7500	90.488	3.5625	84.138	3.3125	69.850	2.7500	6.4	3.2	EE333140/333197	1	1 600	2 550	250	95.2	376	391	488	465	482	7	20.6	6.4	3.2	0.37	1.60	0.88	50.7
360	—	480	—	76	—	76	—	57	—	4	3	32972JR	1	1 350	2 400	231	96.2	378	379	466	438	466	12	19	3	2.5	0.46	1.31	0.72	37.1
368.249	14.4980	523.875	20.6250	101.600	4.0000	101.600	4.0000	79.375	3.1250	6.4	6.4	HM265049/HM265010	1-P	1 990	3 390	322	94.0	388	408	500	483	500	7	22.2	6.4	6.4	0.33	1.80	0.99	56.6
368.300	14.5000	596.900	23.5000	95.250	3.7500	92.075	3.6250	60.325	2.3750	9.5	6.4	EE181453/182350	1	1 820	2 330	234	104.3	395	431	575	535	545	11	34.9	9.5	6.4	0.42	1.44	0.79	83.0
	14.5000	609.600	24.0000	142.875	5.6250	139.700	5.5000	111.125	4.3750	7.9	6.4	EE321145/321240	1	3 160	4 530	406	121.4	392	427	585	545	570	7	31.8	7.9	6.4	0.36	1.69	0.93	152
371.475	14.6250	501.650	19.7500	74.613	2.9375	66.675	2.6250	50.800	2.0000	6.4	3.2	EE231462/231975	1	989	1 640	161	97.3	392	409	488	465	480	2	23.8	6.4	3.2	0.44	1.36	0.75	35.8
	14.6250	514.350	20.2500	74.613	2.9375	66.675	2.6250	50.800	2.0000	6.4	3.2	EE231462/232025	1	989	1 640	161	97.3	392	409	500	465	480	2	23.8	6.4	3.2	0.44	1.36	0.75	39.8
381.000	15.0000	479.425	18.8750	49.213	1.9375	47.625	1.8750	34.925	1.3750	6.4	3.2	L865547/L865512	1	746	1 280	128	91.4	401	405	466	454	465	8	14.3	6.4	3.2	0.49	1.23	0.68	18.9
	15.0000	508.000	20.0000	63.500	2.5000	58.738	2.3125	38.100	1.5000	6.4	3.2	EE192150/192200	1	865	1 490	144	101.9	401	412	494	466	479	9	25.4	6.4	3.2	0.53	1.13	0.62	30.0

[Note] 1) While metric series bearings have minus tolerances for bore and OD, inch series have plus tolerances. Refer to page 194 for details of applicable tolerance standards.

Single-row tapered roller bearings

d (381.000) ~ 430.213 mm

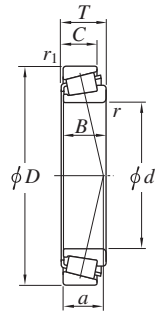

Design 1



Design 1-P

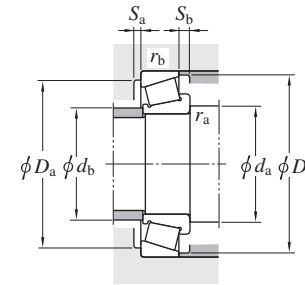

Boundary dimensions										Bearing No. 1)	De- sign	Basic load ratings (kN)		Fatigue load limit (kN) Cu	Load center (mm) a	Mounting dimensions (mm)								Con- stant e	Axial load factors		(Refer.) Mass (kg)			
d	D		T		B		C		r			r1	Cr			Cor	da	db	Da	Db	Sa	Sb	ra		rb	Y1		Y0		
mm	1/25.4	mm	1/25.4	mm	1/25.4	mm	1/25.4	mm	1/25.4	min.	min.			min.	max.	max.	min.	min.	min.	min.	max.	max.								
381.000	15.0000	522.288	20.5625	85.725	3.3750	84.138	3.3125	61.913	2.4375	6.4	3.2	LM565949/LM565910	1	1 460	2 590	247	92.8	401	414	505	480	496	10	23.8	6.4	3.2	0.38	1.56	0.86	50.0
	15.0000	523.875	20.6250	85.725	3.3750	84.138	3.3125	61.913	2.4375	6.4	3.2	LM565949/LM565912	1	1 460	2 590	247	92.8	401	414	510	480	496	10	23.8	6.4	3.2	0.38	1.56	0.86	50.7
	15.0000	546.100	21.5000	104.775	4.1250	104.775	4.1250	82.550	3.2500	6.4	6.4	HM266446/HM266410	1-P	2 390	4 210	386	97.6	401	421	525	505	515	10	22.2	6.4	6.4	0.33	1.80	0.99	79.5
384.175	15.1250	546.100	21.5000	104.775	4.1250	104.775	4.1250	82.550	3.2500	6.4	6.4	HM266448/HM266410	1-P	2 390	4 210	386	97.6	404	421	525	505	515	10	22.2	6.4	6.4	0.33	1.80	0.99	78.0
385.763	15.1875	514.350	20.2500	82.550	3.2500	82.550	3.2500	63.500	2.5000	6.4	3.2	LM665949/LM665910	1	1 510	2 710	258	98.2	406	411	500	477	494	9	19.1	6.4	3.2	0.42	1.43	0.79	44.6
393.700	15.5000	546.100	21.5000	76.200	3.0000	61.120	2.4063	55.562	2.1875	6.4	6.4	EE234154/234215	1	1 090	1 910	178	113.3	414	441	525	497	510	1	20.6	6.4	6.4	0.48	1.26	0.69	46.4
396.875	15.6250	546.100	21.5000	76.200	3.0000	61.120	2.4063	55.562	2.1875	6.4	6.4	EE234156/234215	1	1 090	1 910	178	113.3	417	441	525	497	510	1	20.6	6.4	6.4	0.48	1.26	0.69	45.5
	15.6250	558.800	22.0000	65.088	2.5625	61.120	2.4063	44.450	1.7500	6.4	6.4	EE234156/234220	1	1 090	1 910	178	102.2	417	441	535	505	510	10	20.6	6.4	6.4	0.48	1.26	0.69	44.9
406.400	16.0000	508.000	20.0000	61.913	2.4375	61.913	2.4375	47.625	1.8750	3.2	3.2	L467549/L467510	1	1 070	2 130	202	82.1	421	428	493	477	489	9	14.3	3.2	3.2	0.37	1.64	0.90	27.2
	16.0000	546.100	21.5000	76.200	3.0000	61.120	2.4063	55.562	2.1875	6.4	6.4	EE234160/234215	1	1 090	1 910	178	113.3	428	441	520	497	510	1	20.6	6.4	6.4	0.48	1.26	0.69	—
	16.0000	546.100	21.5000	87.313	3.4375	87.313	3.4375	68.263	2.6875	6.4	6.4	M667944/M667911	1	1 660	2 870	271	105.1	428	438	520	510	525	8	19.1	6.4	6.4	0.42	1.44	0.79	53.7
	16.0000	558.800	22.0000	65.088	2.5625	61.120	2.4063	44.450	1.7500	6.4	6.4	EE234160/234220	1	1 090	1 910	178	102.2	428	441	535	505	510	10	20.6	6.4	6.4	0.48	1.26	0.69	42.0
	16.0000	574.675	22.6250	76.200	3.0000	67.866	2.6719	50.800	2.0000	6.7	3.2	EE285160/285226	1	1 190	1 940	183	114.9	428	450	560	520	530	5	25.4	6.7	3.2	0.50	1.20	0.66	53.3
	16.0000	590.550	23.2500	107.950	4.2500	107.950	4.2500	80.963	3.1875	9.5	6.4	EE833160X/833232	1	2 240	3 540	329	100.0	434	453	565	545	560	9	27	9.5	6.4	0.32	1.85	1.02	89.7
	16.0000	609.524	23.9970	82.550	3.2500	79.375	3.1250	60.325	2.3750	7.9	6.4	EE736160/736238	1	1 900	3 030	283	95.9	431	477	585	565	570	8	22.2	7.9	6.4	0.35	1.73	0.95	76.2
	16.0000	609.600	24.0000	92.075	3.6250	84.138	3.3125	60.325	2.3750	6.7	6.4	EE911600/912400	1	1 790	2 640	251	105.6	428	466	585	555	570	5	31.8	6.7	6.4	0.38	1.57	0.86	80.1
16.0000	673.100	26.5000	88.900	3.5000	87.833	3.4580	60.325	2.3750	6.4	3.2	EE571602/572650	1	1 850	2 620	247	111.7	428	505	655	610	620	8	28.6	6.4	3.2	0.40	1.49	0.82	109	
409.575	16.1250	546.100	21.5000	87.313	3.4375	87.313	3.4375	68.263	2.6875	6.4	6.4	M667947/M667911	1	1 660	2 870	271	105.1	431	438	520	510	525	8	19.1	6.4	6.4	0.42	1.44	0.79	52.4
	16.1250	546.100	21.5000	87.313	3.4375	87.313	3.4375	66.675	2.6250	6.4	6.4	M667948/M667910	1	1 660	2 870	271	105.1	431	438	520	510	525	8	20.6	6.4	6.4	0.42	1.44	0.79	52.2
411.163	16.1875	609.600	24.0000	92.075	3.6250	84.138	3.3125	60.325	2.3750	6.7	6.4	EE911618/912400	1	1 790	2 640	251	105.6	433	466	585	555	570	5	31.8	6.7	6.4	0.38	1.57	0.86	78.1
415.925	16.3750	590.550	23.2500	114.300	4.5000	114.300	4.5000	88.900	3.5000	6.4	6.4	M268749/M268710	1-P	2 480	4 470	401	103.7	437	460	565	545	560	9	25.4	6.4	6.4	0.33	1.80	0.99	96.1
430.213	16.9375	603.250	23.7500	76.200	3.0000	73.025	2.8750	50.800	2.0000	6.4	6.4	EE241693/242375	1	1 220	1 880	180	122.8	451	473	580	545	560	2	25.4	6.4	6.4	0.53	1.14	0.63	54.0

[Note] 1) While metric series bearings have minus tolerances for bore and OD, inch series have plus tolerances. Refer to page 194 for details of applicable tolerance standards.

Single-row tapered roller bearings

d 431.800 ~ 488.950 mm

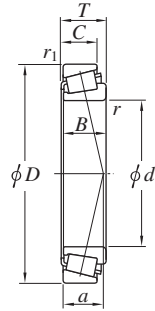

Design 1



Design 1-P

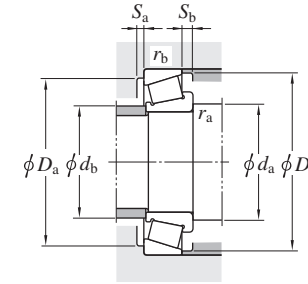

Boundary dimensions										Bearing No. ¹⁾	De- sign	Basic load ratings (kN)		Fatigue load limit (kN) <i>C_u</i>	Load center (mm) <i>a</i>	Mounting dimensions (mm)								Con- stant <i>e</i>	Axial load factors		(Refer.) Mass (kg)			
<i>d</i>	<i>D</i>	<i>T</i>	<i>B</i>	<i>C</i>	<i>r</i>	<i>r₁</i>	<i>C_r</i>	<i>C_{0r}</i>	<i>d_a</i>			<i>d_b</i>	<i>D_a</i>			<i>D_b</i>	<i>S_a</i>	<i>S_b</i>	<i>r_a</i>	<i>r_b</i>	<i>Y₁</i>	<i>Y₀</i>								
mm	1/25.4	mm	1/25.4	mm	1/25.4	mm	1/25.4	mm	1/25.4	min.	min.	min.	max.	max.	min.	min.	min.	max.	max.	min.	max.	min.	max.	min.	max.	min.	max.	min.	max.	
431.800	17.0000	571.500	22.5000	74.613	2.9375	74.613	2.9375	52.388	2.0625	3.2	3.2	LM869448/LM869410	1	1 230	2 140	202	124.4	447	468	555	535	550	7	22.2	3.2	3.2	0.55	1.10	0.60	47.1
	17.0000	571.500	22.5000	76.200	3.0000	73.025	2.8750	57.150	2.2500	3.2	3.2	EE239170/239225A	1	1 230	2 150	200	99.7	447	470	555	535	540	2	19.1	3.2	3.2	0.38	1.57	0.86	46.8
	17.0000	603.250	23.7500	76.200	3.0000	73.025	2.8750	50.800	2.0000	6.4	6.4	EE241701/242375	1	1 220	1 880	180	122.8	453	473	580	545	560	2	25.4	6.4	6.4	0.53	1.14	0.63	53.4
	17.0000	673.100	26.5000	88.900	3.5000	87.833	3.4580	60.325	2.3750	6.4	3.2	EE571703/572650	1	1 850	2 620	247	111.7	453	505	655	610	620	8	28.6	6.4	3.2	0.40	1.49	0.82	97.4
441.325	17.3750	660.400	26.0000	91.280	3.5937	85.725	3.3750	62.705	2.4687	10.4	6.4	EE737173/737260	1	1 690	2 630	241	109.5	471	510	635	600	610	7	28.6	10.4	6.4	0.37	1.60	0.88	95.5
447.675	17.6250	552.450	21.7500	44.450	1.7500	44.450	1.7500	31.750	1.2500	3.2	3.2	80176/80217	1	798	1 520	147	72.4	463	481	535	525	530	10	12.7	3.2	3.2	0.32	1.88	1.04	21.0
	17.6250	565.150	22.2500	44.450	1.7500	44.450	1.7500	31.750	1.2500	3.2	3.2	80176/80222	1	798	1 520	147	72.4	463	481	550	525	530	10	12.7	3.2	3.2	0.32	1.88	1.04	23.8
	17.6250	635.000	25.0000	120.650	4.7500	120.650	4.7500	95.250	3.7500	6.4	6.4	M270749/M270710	1-P	2 870	5 250	458	113.8	469	495	610	585	600	8	25.4	6.4	6.4	0.33	1.80	0.99	118
450.850	17.7500	603.250	23.7500	85.725	3.3750	84.138	3.3125	60.325	2.3750	6.4	3.2	LM770945/LM770910	1	1 730	3 170	290	116.0	472	493	585	565	580	10	25.4	6.4	3.2	0.45	1.32	0.73	63.4
456.692	17.9800	660.400	26.0000	92.075	3.6250	91.262	3.5930	63.500	2.5000	6.4	6.4	EE737179X/737262	1	1 690	2 630	241	110.3	478	510	635	600	610	6	28.6	6.4	6.4	0.37	1.60	0.88	90.5
456.794	17.9840	761.873	29.9950	142.875	5.6250	142.875	5.6250	101.600	4.0000	16	6.4	EE425179A/425299	1-P	3 990	5 610	479	154.5	497	530	740	685	710	8	41.3	16	6.4	0.44	1.35	0.74	242
457.200	18.0000	573.088	22.5625	74.613	2.9375	74.613	2.9375	57.150	2.2500	6.4	6.4	L570649/L570610	1	1 380	2 930	263	100.4	478	484	550	540	550	10	17.5	6.4	6.4	0.40	1.49	0.82	42.7
	18.0000	596.900	23.5000	76.200	3.0000	73.025	2.8750	53.975	2.1250	9.5	3.2	EE244180/244235	1	1 410	2 620	243	103.1	485	492	580	555	570	7	22.2	9.5	3.2	0.40	1.48	0.82	50.1
	18.0000	615.950	24.2500	85.725	3.3750	85.725	3.3750	66.675	2.6250	6.4	6.4	LM272235/LM272210	1	1 770	3 560	320	98.4	478	515	590	585	590	8	19.1	6.4	6.4	0.33	1.80	0.99	71.8
476.250	18.7500	565.150	22.2500	41.275	1.6250	41.275	1.6250	31.750	1.2500	3.2	3.2	LL771948/LL771911	1	653	1 530	153	99.3	491	499	550	535	540	8	9.5	3.2	3.2	0.47	1.28	0.70	18.4
479.425	18.8750	679.450	26.7500	128.588	5.0625	128.588	5.0625	101.600	4.0000	6.4	6.4	M272749/M272710	1-P	3 100	5 550	476	122.2	500	530	655	630	645	7	27	6.4	6.4	0.33	1.80	0.99	140
482.600	19.0000	615.950	24.2500	85.725	3.3750	85.725	3.3750	66.675	2.6250	6.4	6.4	LM272249/LM272210	1	1 770	3 560	320	98.4	505	515	590	585	590	8	19.1	6.4	6.4	0.33	1.80	0.99	59.3
	19.0000	634.873	24.9950	80.963	3.1875	80.963	3.1875	63.500	2.5000	6.4	3.2	EE243190/243250	1	1 660	3 290	292	100.0	505	530	620	595	605	9	17.5	6.4	3.2	0.34	1.75	0.96	66.3
488.671	19.2390	660.400	26.0000	93.663	3.6875	94.458	3.7188	69.850	2.7500	6.4	6.4	EE640191/640260	1-P	2 260	3 960	357	98.4	510	530	635	615	630	11	23.8	6.4	6.4	0.31	1.95	1.07	86.9
488.950	19.2500	634.873	24.9950	84.138	3.3125	84.138	3.3125	61.913	2.4375	6.4	3.2	LM772748/LM772710	1	1 800	3 420	307	124.5	510	515	620	595	610	9	22.2	6.4	3.2	0.47	1.27	0.70	63.7
	19.2500	660.400	26.0000	93.663	3.6875	94.458	3.7188	69.850	2.7500	6.4	6.4	EE640192/640260	1-P	2 260	3 960	357	98.4	510	530	635	615	630	11	23.8	6.4	6.4	0.31	1.95	1.07	86.8

[Note] 1) While metric series bearings have minus tolerances for bore and OD, inch series have plus tolerances. Refer to page 194 for details of applicable tolerance standards.

Single-row tapered roller bearings

d 489.026 ~ 759.924 mm

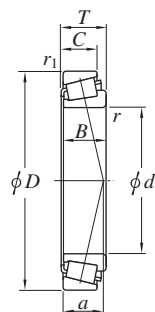

Design 1



Design 1-P

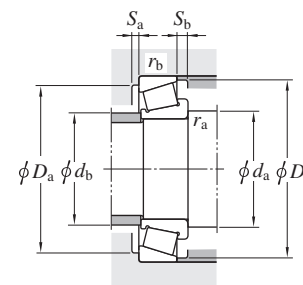

Boundary dimensions										Bearing No. ¹⁾	De- sign	Basic load ratings (kN)		Fatigue load limit (kN) C_u	Load center (mm) a	Mounting dimensions (mm)								Con- stant e	Axial load factors Y_1 Y_0		(Refer.) Mass (kg)			
d mm	D mm	T mm	B mm	C mm	r min.	r_1 min.	C_r	C_{Or}	d_a min.			d_b max.	D_a max.			D_b min.	S_a min.	S_b min.	r_a max.	r_b max.	e	Y_1	Y_0		Mass					
489.026	19.2530	634.873	24.9950	80.963	3.1875	80.963	3.1875	63.500	2.5000	6.4	3.2	EE243192/243250	1	1 660	3 290	292	100.0	510	530	620	595	605	9	17.5	6.4	3.2	0.34	1.75	0.96	63.2
498.475	19.6250	634.873	24.9950	80.963	3.1875	80.963	3.1875	63.500	2.5000	6.4	3.2	EE243196/243250	1	1 660	3 290	292	100.0	520	530	620	595	605	9	17.5	6.4	3.2	0.34	1.75	0.96	58.6
501.650	19.7500	711.200	28.0000	136.525	5.3750	136.525	5.3750	106.363	4.1875	6.4	6.4	M274149/M274110	1-P	3 590	6 410	551	126.8	525	550	685	655	675	10	30.2	6.4	6.4	0.33	1.80	0.99	164
520.700	20.5000	736.600	29.0000	88.900	3.5000	81.758	3.2188	53.975	2.1250	6.4	3.2	EE982051/982900	1-P	1 840	2 580	238	136.4	545	570	720	675	690	5	34.9	6.4	3.2	0.48	1.26	0.69	97.5
536.575	21.1250	761.873	29.9950	146.050	5.7500	146.050	5.7500	114.300	4.5000	6.4	6.4	M276449/M276410	1-P	4 120	7 190	595	135.7	560	580	740	700	720	9	31.8	6.4	6.4	0.33	1.80	0.99	202
539.750	21.2500	635.000	25.0000	50.800	2.0000	50.800	2.0000	38.100	1.5000	6.4	6.4	LL575349/LL575310	1	943	1 970	175	101.4	565	560	610	610	620	9	12.7	6.4	6.4	0.41	1.48	0.81	25.7
549.097	21.6180	692.150	27.2500	80.963	3.1875	80.962	3.1875	61.913	2.4375	6.4	6.4	L476548/L476510	1	1 760	3 700	325	113.6	570	580	670	650	660	9	19.1	6.4	6.4	0.38	1.59	0.88	67.7
549.275	21.6250	692.150	27.2500	80.963	3.1875	80.963	3.1875	61.913	2.4375	6.4	6.4	L476549/L476510	1	1 760	3 700	325	113.6	575	580	670	650	660	9	19.1	6.4	6.4	0.38	1.59	0.88	67.5
558.800	22.0000	736.600	29.0000	88.108	3.4688	88.108	3.4688	63.500	2.5000	6.4	6.4	EE843220/843290	1-P	2 170	4 020	357	110.7	580	610	710	695	705	9	24.6	6.4	6.4	0.34	1.75	0.96	94.2
584.200	23.0000	685.800	27.0000	49.213	1.9375	49.213	1.9375	34.925	1.3750	3.6	3.2	LL778149/LL778110	1	908	1 930	172	113.8	600	610	670	660	665	10	14.3	3.6	3.2	0.44	1.36	0.75	29.4
607.720	23.9260	787.400	31.0000	93.663	3.6875	93.663	3.6875	69.850	2.7500	6.4	6.4	EE649239/649310	1-P	2 480	4 970	420	126.9	630	650	760	740	750	12	23.8	6.4	6.4	0.37	1.61	0.89	113
609.600	24.0000	762.000	30.0000	95.250	3.7500	92.075	3.6250	71.438	2.8125	6.4	6.4	L879947/L879910	1	2 140	4 510	379	153.0	635	640	735	720	740	9	23.8	6.4	6.4	0.49	1.23	0.67	91.2
	24.0000	787.400	31.0000	93.663	3.6875	93.663	3.6875	69.850	2.7500	6.4	6.4	EE649240/649310	1-P	2 480	4 970	420	126.9	635	650	760	740	750	12	23.8	6.4	6.4	0.37	1.61	0.89	112
	24.0000	812.800	32.0000	82.550	3.2500	82.550	3.2500	60.325	2.3750	6.4	6.4	EE743240/743320	1-P	2 390	4 290	371	112.7	635	660	790	755	765	12	22.2	6.4	6.4	0.33	1.83	1.01	112
660.400	26.0000	854.075	33.6250	85.725	3.3750	85.468	3.3649	60.325	2.3750	9.5	6.4	EE749260/749336	1-P	2 280	4 000	345	125.1	690	705	830	800	810	8	25.4	9.5	6.4	0.35	1.71	0.94	111
685.800	27.0000	876.300	34.5000	93.663	3.6875	92.075	3.6250	69.850	2.7500	6.4	6.4	EE655270/655345	1-P	2 570	5 390	440	149.1	710	735	850	830	840	9	23.8	6.4	6.4	0.42	1.44	0.79	132
749.300	29.5000	990.600	39.0000	159.500	6.2795	160.338	6.3125	123.000	4.8425	6.4	6.4	LM283649/LM283610	1-P	5 730	11 900	890	261.4	775	800	960	930	950	12	36.5	6.4	6.4	0.32	1.88	1.04	327
759.924	29.9183	889.000	35.0000	88.900	3.5000	88.900	3.5000	71.999	2.8346	3.2	3.2	L183448/L183410	1	2 330	5 630	451	123.1	780	785	870	860	870	11	16.9	3.2	3.2	0.31	1.97	1.08	90.5

[Note] 1) While metric series bearings have minus tolerances for bore and OD, inch series have plus tolerances. Refer to page 194 for details of applicable tolerance standards.

Single-row tapered roller bearings

d 762.000 ~ 1 092.200 mm

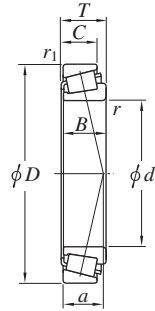

Design 1



Design 1-P

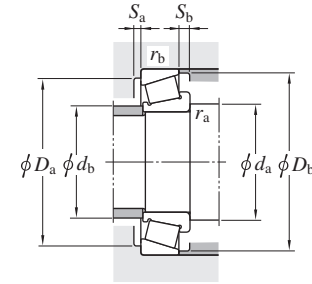

Boundary dimensions										Bearing No. ¹⁾	De- sign	Basic load ratings (kN)		Fatigue load limit (kN) C_u	Load center (mm) a	Mounting dimensions (mm)								Con- stant e	Axial load factors Y_1 Y_0		(Refer.) Mass (kg)			
d mm	D mm	T mm	B mm	C mm	r min.	r_1 min.	C_r	C_{Or}	d_a min.			d_b max.	D_a max.			D_b min.	S_a min.	S_b min.	r_a max.	r_b max.	e	Y_1	Y_0		Mass					
762.000	30.0000	889.000	35.0000	88.900	3.5000	88.900	3.5000	71.999	2.8346	3.2	3.2	L183449/L183410	1	2 330	5 630	451	123.1	780	785	870	860	870	11	16.9	3.2	3.2	0.31	1.97	1.08	88.8
	30.0000	965.200	38.0000	93.663	3.6875	80.963	3.1875	66.675	2.6250	6.4	3.2	EE752300/752380	1-P	2 290	4 790	392	159.7	785	820	940	910	920	1	27	6.4	3.2	0.40	1.49	0.82	143
1 092.200	43.0000	1 320.800	52.0000	95.250	3.7500	88.900	3.5000	69.850	2.7500	6.4	6.4	EE776430/776520	1-P	3 330	7 140	540	170.5	1 120	1 140	1 290	1 260	1 280	10	25.4	6.4	6.4	0.57	1.05	0.58	240

[Note] 1) While metric series bearings have minus tolerances for bore and OD, inch series have plus tolerances. Refer to page 194 for details of applicable tolerance standards.

Double-row tapered roller bearings

TDI type

d 100 ~ 150 mm

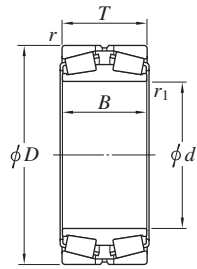

Design 1

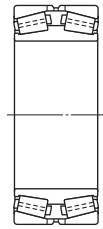

Design 1-P

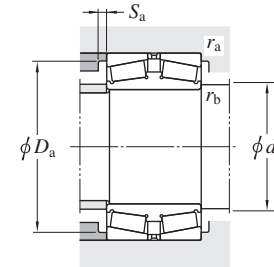

Boundary dimensions								Basic load ratings (kN)		Fatigue load limit (kN)	Design	Mounting dimensions (mm)						Constant	Axial load factors			(Refer.) Mass (kg)				
d mm	D mm	B mm	T mm	r min.	r_1 min.	C_r	C_{0r}	C_u	Bearing No. ¹⁾	d_a max.		D_a max.	S_a min.	r_a max.	r_b max.	e	Y_2	Y_3	Y_0	Mass (kg)						
100	—	165	—	52	—	52	—	2	2.5	298	384	55.9		45320	1	119	155	148	3.9	2	2	0.35	1.95	2.90	1.91	4.26
110	—	180	—	56	—	56	—	2	2.5	378	505	72.2		45322	1	128	170	160	4	2	2	0.35	1.95	2.90	1.91	5.40
120	—	180	—	46	—	46	—	2	2.5	286	424	59.4		45224	1	138	170	163	4	2	2	0.26	2.55	3.80	2.50	4.08
	—	200	—	62	—	62	—	2	2.5	444	598	83.4		45324	1	142	190	178	4	2	2	0.35	1.95	2.90	1.91	7.92
127.000	5.0000	182.563	7.1875	76.200	3.0000	76.200	3.0000	3.2	1.6	487	858	120		48290D/48220	1	141	171	167	3.8	3.2	1.6	0.31	2.21	3.29	2.16	6.57
	5.0000	234.950	9.2500	139.700	5.5000	152.400	6.0000	3.2	5.2	1 120	1 650	200		95499D/95925	1	151	223	205	8	3.2	5.2	0.37	1.83	2.72	1.79	27.1
	5.0000	254.000	10.0000	161.925	6.3750	171.450	6.7500	6.4	3.2	1 480	2 010	240		EE153053D/153100	1	154	236	218	11	6.4	3.2	0.32	2.10	3.13	2.05	39.2
130	—	200	—	52	—	52	—	2	2.5	376	548	75.6		45226	1	152	190	179	4	2	2	0.27	2.47	3.67	2.41	5.96
	—	210	—	64	—	64	—	2	2.5	476	657	90.3		45326	1	153	200	185	4	2	2	0.36	1.87	2.79	1.83	8.41
130.005	5.1183	215.900	8.5000	123.825	4.8750	123.825	4.8750	3.2	1.6	691	1 100	132		74510D/74850	1	154	204	194	5	3.2	1.6	0.49	1.38	2.06	1.35	17.3
133.350	5.2500	196.850	7.7500	92.075	3.6250	92.075	3.6250	3.2	1.6	669	1 120	137		67390D/67322	1	146	185	181	5	3.2	1.6	0.34	1.96	2.92	1.92	9.46
	5.2500	203.200	8.0000	92.075	3.6250	92.075	3.6250	3.2	1.6	669	1 120	137		67390D/67320	1	146	191	181	5	3.2	1.6	0.34	1.96	2.92	1.92	10.9
136.525	5.3750	190.500	7.5000	77.788	3.0625	77.788	3.0625	3.2	1.6	505	944	129		48393D/48320	1	150	179	175	4.7	3.2	1.6	0.32	2.10	3.13	2.06	6.87
	5.3750	225.425	8.8750	120.650	4.7500	120.650	4.7500	3.2	1.6	1 020	1 610	194		H228649D/H228610	1	156	214	202	6	3.2	1.6	0.33	2.03	3.02	1.98	19.4
139.700	5.5000	200.025	7.8750	77.788	3.0625	75.408	2.9688	3.3	0.8	527	982	133		48680D/48620	1	155	188	183	4	3.3	0.8	0.34	2.01	2.99	1.96	8.01
140	—	210	—	53	—	53	—	2	2.5	390	564	76.9		45228	1	159	200	188	4	2	2	0.27	2.47	3.67	2.41	6.45
	—	225	—	68	—	68	—	2.5	3	611	807	103		45328	1	160	213	210	4	2	2.5	0.40	1.68	2.50	1.64	10.0
	—	250	—	88	—	88	—	3	4	769	915	117		45T282509	1	166	236	224	7.5	2.5	3	0.43	1.57	2.34	1.53	16.0
149.225	5.8750	254.000	10.0000	120.650	4.7500	120.650	4.7500	3.2	1.6	1 180	1 830	215		99587D/99100	1	172	242	224	8	3.2	1.6	0.41	1.66	2.47	1.62	26.0
150	—	225	—	56	—	56	—	2.5	3	445	686	91.6		45230	1	174	213	203	4	2	2.5	0.26	2.55	3.80	2.50	7.87
	—	225	—	75	—	75	—	2.5	1	640	965	129		45T302308	1	167	213	206	6.5	2	0.8	0.40	1.68	2.50	1.64	9.78
	—	250	—	80	—	80	—	2.5	3	684	955	120		45330	1	179	238	220	4	2	2.5	0.35	1.95	2.90	1.91	15.5
	—	250	—	100	—	100	—	2.5	3	966	1 510	182		45T302510A	1	179	238	226	6.5	2	2.5	0.40	1.68	2.50	1.64	20.0

[Note] 1) While metric series bearings have minus tolerances for bore and OD, inch series have plus tolerances. Refer to page 194 for details of applicable tolerance standards.

Double-row tapered roller bearings

TDI type

d 152.400 ~ (190) mm

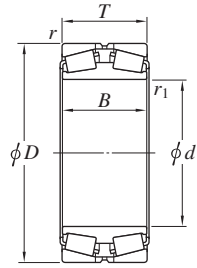

Design 1



Design 1-P

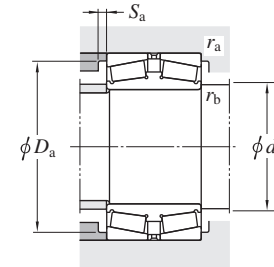

Boundary dimensions										Basic load ratings (kN)		Fatigue load limit (kN)	Bearing No. ¹⁾	Design	Mounting dimensions (mm)						Constant	Axial load factors			(Refer.) Mass (kg)
<i>d</i> mm	<i>D</i> mm	<i>B</i> mm	<i>T</i> mm	<i>r</i> mm	<i>r</i> ₁ mm	<i>C</i> _r	<i>C</i> _{0r}	<i>C</i> _u	<i>e</i>	<i>Y</i> ₂	<i>Y</i> ₃	<i>Y</i> ₀			<i>d</i> _a max.	<i>D</i> _a max.	<i>S</i> _a min.	<i>r</i> _a max.	<i>r</i> _b max.	<i>e</i>	<i>Y</i> ₂	<i>Y</i> ₃	<i>Y</i> ₀	(kg)	
152.400	6.0000	222.250	8.7500	84.138	3.3125	84.138	3.3125	1.6	1.6	678	1 190	159	M231649D/M231610 99600D/99100 99603D/99100	1	168	214	202	6	1.6	1.6	0.33	2.03	3.02	1.98	11.0
	6.0000	254.000	10.0000	133.350	5.2500	133.350	5.2500	3.2	1.6	1 180	1 830	215		1	172	242	224	8	3.2	1.6	0.41	1.66	2.47	1.62	27.2
	6.0000	254.000	10.0000	158.750	6.2500	158.750	6.2500	3.2	1.6	1 180	1 830	215		1	172	242	224	8	3.2	1.6	0.41	1.66	2.47	1.62	31.1
160	—	240	—	60	—	60	—	2.5	3	488	705	93.1	45232 45T322411 45332	1	184	228	217	5	2	2.5	0.24	2.79	4.15	2.73	9.22
	—	240	—	110	—	110	—	2.5	3	946	1 530	179		1	176	228	220	6	2	2.5	0.33	2.03	3.02	1.98	16.7
	—	270	—	86	—	86	—	2.5	3	832	1 100	146		1	193	258	237	4	2	2.5	0.35	1.95	2.90	1.91	19.8
170	—	260	—	67	—	67	—	2.5	3	654	956	124	45234 45334	1	195	248	233	5	2	2.5	0.31	2.21	3.29	2.16	12.4
	—	280	—	88	—	88	—	2.5	3	834	1 210	145		1	201	268	247	5	2	2.5	0.33	2.03	3.02	1.98	21.6
177.800	7.0000	247.650	9.7500	90.488	3.5625	90.488	3.5625	3.2	1.6	741	1 400	160	67790D/67720 82680D/82620 EE91700D/91112 94706D/94113 HM237546D/HM237510 HM237546DD/HM237510 EE280700D/281200	1	190	236	227	5	3.2	1.6	0.44	1.54	2.29	1.50	13.3
	7.0000	279.400	11.0000	112.710	4.4374	112.713	4.4375	3.2	1.6	1 040	1 640	187		1	197	268	252	7	3.2	1.6	0.52	1.29	1.92	1.26	25.1
	7.0000	285.750	11.2500	106.360	4.1874	106.363	4.1875	3.2	1.6	956	1 430	165		1	201	274	252	4	3.2	1.6	0.43	1.57	2.34	1.53	26.0
	7.0000	288.925	11.3750	123.825	4.8750	123.825	4.8750	3.2	1.6	1 180	1 920	216		1	201	277	255	8	3.2	1.6	0.47	1.44	2.15	1.41	32.1
	7.0000	288.925	11.3750	123.825	4.8750	123.825	4.8750	3.2	1.6	1 430	1 950	245		1	201	277	261	8	3.2	1.6	0.32	2.12	3.15	2.07	30.8
	7.0000	288.925	11.3750	158.750	6.2500	158.750	6.2500	3.2	1.6	1 430	1 950	245		1	201	277.5	261	8	3.2	1.6	0.32	2.12	3.15	2.07	37.0
	7.0000	304.800	12.0000	109.438	4.3086	114.300	4.5000	3.2	3.2	1 220	1 690	199		1	208	293	272	7	3.2	3.2	0.36	1.87	2.79	1.83	33.1
180	—	254	—	90	—	90	—	2.5	3	715	1 270	163	45T362509 45236 45336 45T363319	1	199	242	234	6	2	2.5	0.33	2.03	3.02	1.98	14.0
	—	280	—	74	—	74	—	2.5	3	722	1 050	125		1	208	268	250	5	2	2.5	0.28	2.43	3.61	2.37	16.8
	—	300	—	96	—	96	—	3	4	992	1 370	162		1	210	286	263	5	2.5	3	0.35	1.95	2.90	1.91	26.5
	—	330	—	190	—	190	—	5	1.5	2 110	3 260	344		1	202	308	286	6	4	1.5	0.58	1.17	1.75	1.15	71.8
187.325	7.3750	269.875	10.6250	101.600	4.0000	101.600	4.0000	3.2	1.6	880	1 610	183	M238849D/M238810 EE222074D/222126 H239649D/H239610 EE222074D/222128 H239649D/H239612	1	207	258	246	5	3.2	1.6	0.33	2.03	3.02	1.98	19.0
	7.3750	319.964	12.5970	168.275	6.6250	161.925	6.3750	4.8	3.2	1 610	2 450	271		1	212	305	281	4	4.8	3.2	0.40	1.68	2.50	1.64	53.8
	7.3750	319.964	12.5970	168.275	6.6250	161.925	6.3750	4.8	3.2	1 830	2 530	285		1	212	305	287	5	4.8	3.2	0.32	2.12	3.15	2.07	51.4
	7.3750	320.675	12.6250	168.275	6.6250	161.925	6.3750	4.8	3.2	1 610	2 450	271		1	212	306	281	4	4.8	3.2	0.40	1.68	2.50	1.64	54.3
	7.3750	320.675	12.6250	168.275	6.6250	161.925	6.3750	4.8	3.2	1 830	2 530	285		1	212	306	287	5	4.8	3.2	0.32	2.12	3.15	2.07	51.9
190	—	290	—	75	—	75	—	2.5	3	751	1 130	133	45238 45T383014	1	219	278	260	5	2	2.5	0.26	2.55	3.80	2.50	17.7
	—	300	—	140	—	140	—	2.5	1.5	737	2 110	137		1	207	288	268	7	2	1	0.62	1.09	1.62	1.06	35.9

[Note] 1) While metric series bearings have minus tolerances for bore and OD, inch series have plus tolerances. Refer to page 194 for details of applicable tolerance standards.

Double-row tapered roller bearings

TDI type

d (190) ~ 220 mm

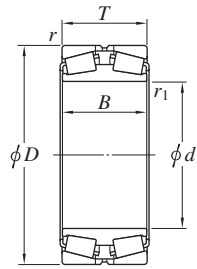

Design 1

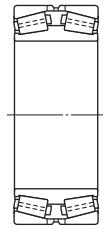

Design 1-P

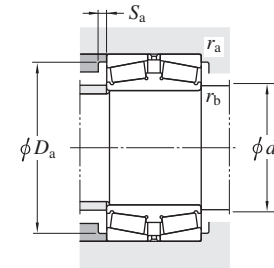

Boundary dimensions										Basic load ratings (kN)		Fatigue load limit (kN)	Bearing No. ¹⁾	Design	Mounting dimensions (mm)					Constant	Axial load factors			(Refer.) Mass (kg)	
d mm	D mm	B mm	T mm	r min.	r_1 min.	C_r	C_{0r}	C_u			d_a max.	D_a max.			S_a min.	r_a max.	r_b max.	e	Y_2	Y_3	Y_0				
190	—	320	—	104	—	104	—	3	4	1 130	1 590	183	45338	1	224	306	280	5	2.5	3	0.35	1.95	2.90	1.91	34.0
190.500	7.5000	365.049	14.3720	158.750	6.2500	152.400	6.0000	3.2	3.2	2 020	2 920	319	EE420750D/421437	1	239	353	317	6	3.2	3.2	0.40	1.68	2.50	1.64	77.2
	7.5000	368.300	14.5000	158.750	6.2500	152.400	6.0000	3.2	3.2	2 020	2 920	319	EE420750D/421450	1	239	356	317	6	3.2	3.2	0.40	1.68	2.50	1.64	79.4
199.975	7.8730	317.500	12.5000	133.350	5.2500	133.350	5.2500	3.2	6.4	1 300	2 270	244	93788D/93125	1	223	306	279	7	3.2	6.4	0.52	1.29	1.92	1.26	40.1
200	—	310	—	82	—	82	—	2.5	3	913	1 410	166	45240	1	234	298	280	5	2	2.5	0.26	2.55	3.80	2.50	22.9
	—	340	—	112	—	112	—	3	4	1 250	1 840	208	45340	1	244	326	300	5	2.5	3	0.35	1.95	2.90	1.91	41.9
	—	340	—	150	—	150	—	3	1.5	1 820	2 950	320	45T403415	1	233	326	301	9.5	2.5	1.5	0.43	1.57	2.34	1.53	57.7
203.200	8.0000	317.500	12.5000	123.825	4.8750	123.825	4.8750	3.2	1.6	1 300	2 270	244	93800D/93125	1	223	305	278	7	3.2	1.6	0.52	1.29	1.92	1.26	36.5
	8.0000	317.500	12.5000	133.350	5.2500	133.350	5.2500	3.2	6.4	1 300	2 270	244	93801D/93125	1	223	305	279	7	3.2	6.4	0.52	1.29	1.92	1.26	39.1
	8.0000	365.049	14.3720	158.750	6.2500	152.400	6.0000	3.2	3.2	2 020	2 920	319	EE420800D/421437	1	239	352	317	6	3.2	3.2	0.40	1.68	2.50	1.64	72.5
	8.0000	368.300	14.5000	158.750	6.2500	152.400	6.0000	3.2	3.2	2 020	2 920	319	EE420800D/421450	1	239	355	317	6	3.2	3.2	0.40	1.68	2.50	1.64	74.8
206.375	8.1250	282.575	11.1250	87.313	3.4375	87.313	3.4375	3.2	0.8	749	1 410	155	67985D/67920	1	220	270	260	7	3.2	0.8	0.51	1.33	1.97	1.30	16.1
	8.1250	336.550	13.2500	180.975	7.1250	184.150	7.2500	3.2	1.6	2 230	3 800	400	H242649D/H242610	1	233	324	301	9	3.2	1.6	0.33	2.03	3.02	1.98	65.1
215.900	8.5000	285.750	11.2500	85.725	3.3750	85.725	3.3750	3.2	0.8	766	1 560	190	LM742749D/LM742710	1	228	273	266	6	3.2	0.8	0.48	1.40	2.09	1.37	14.9
	8.5000	288.925	11.3750	85.750	3.3760	85.725	3.3750	3.2	0.8	766	1 560	190	LM742749D/LM742714	1	228	276	266	6	3.2	0.8	0.48	1.40	2.09	1.37	15.8
216.103	8.5080	330.200	13.0000	130.175	5.1250	127.000	5.0000	3.2	1.6	1 430	2 360	255	9974D/9920	1	237	317	301	7	3.2	1.6	0.55	1.22	1.82	1.19	38.8
	8.5080	330.200	13.0000	152.400	6.0000	142.875	5.6250	3.2	3.2	1 430	2 360	255	9977D/9920	1	239	317	301	7	3.2	3.2	0.55	1.22	1.82	1.19	43.3
218.000	—	314.325	—	115.888	—	115.888	—	3.2	1.6	1 400	2 550	281	45T443112	1	240	304	289	9	3.2	1.6	0.33	2.03	3.02	1.98	30.0
219.075	8.6250	358.775	14.1250	196.850	7.7500	200.025	7.8750	6.4	1.6	2 660	4 580	469	H244849D/H244810	1	245	340	320	9	6.4	1.6	0.33	2.03	3.02	1.98	80.9
220	—	320	—	76.2	—	76.2	—	2.5	3	976	1 570	182	45T443208	1	246	308	293	8.5	2	2.5	0.28	2.45	3.64	2.39	21.2
	—	340	—	90	—	90	—	3	4	933	1 460	167	45244	1	259	326	306	5	2.5	3	0.28	2.43	3.61	2.37	28.5
	—	370	—	120	—	120	—	4	5	1 400	2 060	226	45344	1	263	352	324	5	3	4	0.35	1.95	2.90	1.91	50.8
	—	400	—	250	—	254	—	4	1.5	3 880	5 970	591	45T444025	1-P	252	391	355	13	3	1.5	0.40	1.68	2.50	1.64	139

[Note] 1) While metric series bearings have minus tolerances for bore and OD, inch series have plus tolerances. Refer to page 194 for details of applicable tolerance standards.

Double-row tapered roller bearings

TDI type

d 220.663 ~ 254.000 mm

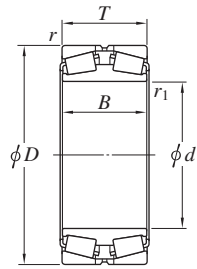

Design 1

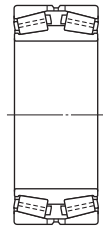

Design 1-P

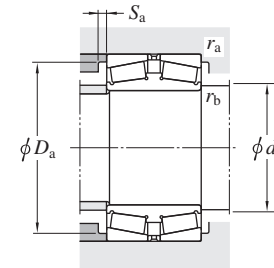

Boundary dimensions										Basic load ratings (kN)		Fatigue load limit	Bearing No. ¹⁾	Design	Mounting dimensions (mm)					Constant e	Axial load factors			(Refer.) Mass (kg)
d mm	D mm	B mm	T mm	$r^{(2)}$ min.	$r_1^{(2)}$ min.	C_r	C_{0r}	C_u		d_a max.	D_a max.	S_a min.			r_a max.	r_b max.	Y_2	Y_3	Y_0					
220.663	314.325	115.888	115.888	3.2	1.6	1 320	2 450	269		M244249D/M244210	1	241	301	289	5	3.2	1.6	0.33	2.03	3.02	1.98	29.0		
228.6	431.8	177.8	177.8	6	6	2 980	4 280	447		45T464318D	1-P	280	403	377	10	5	5	0.40	1.68	2.50	1.64	123		
228.600	400.050	139.700	139.700	3.2	3.2	1 960	2 950	318		EE529091D/529157	1	277	387	352	6	3.2	3.2	0.31	2.19	3.25	2.14	76.3		
230	350	90	90	3	4	991	1 560	177		45246	1	267	336	318	6	2.5	3	0.28	2.43	3.61	2.37	30.6		
234.950	327.025	93.663	93.663	3.2	1.6	1 000	1 860	200		8576D/8520	1	256	314	300	7	3.2	1.6	0.41	1.66	2.47	1.62	24.2		
	384.175	209.550	209.550	6.4	1.6	3 120	5 370	542		H247549D/H247510	1-P	262	365	342	8	6.4	1.6	0.33	2.03	3.02	1.98	99.3		
235	375	170	170	4	1.5	1 800	4 020	283		45T484012	1	268	366	338	8	3	1.5	0.33	2.03	3.02	1.98	73.7		
240	360	92	92	3	4	1 150	1 790	200		45248	1	271	346	325	5	2.5	3	0.32	2.12	3.15	2.07	32.2		
	400	128	128	4	5	1 650	2 470	265		45348	1	286	382	354	5	3	4	0.35	1.95	2.90	1.91	65.4		
	395	124	124	4	5	1 800	2 700	283		45T484012	1	283	373	358	10	3	4	0.40	1.68	2.50	1.64	60.3		
241.300	355.524	109.525	109.525	SP	SP	1 190	2 050	224		45T483611	1	267	336	319	6	2.5	2	0.35	1.91	2.84	1.86	37.0		
	355.600	92.710	92.862	3.2	1.6	1 090	1 850	203		EE170951D/171400	1	278	343	328	10	3.2	1.6	0.36	1.86	2.77	1.82	32.6		
	368.300	92.710	92.862	3.2	1.6	1 090	1 850	203		EE170951D/171450	1	278	355	328	10	3.2	1.6	0.36	1.86	2.77	1.82	37.8		
241.478	349.148	107.950	107.950	3.2	1.6	1 190	2 050	224		EE127097D/127135	1	268	336	320	7	3.2	1.6	0.35	1.91	2.84	1.86	34.0		
244.475	327.025	92.075	92.075	3.2	1.6	985	1 890	203		LM247748D/LM247710	1	265	314	306	7	3.2	1.6	0.32	2.10	3.13	2.06	21.5		
	381.000	146.050	146.050	4.8	3.2	1 690	2 930	306		EE126096D/126150	1	269	365	337	5	4.8	3.2	0.52	1.31	1.95	1.28	62.2		
247.650	400.050	119.060	114.300	6.4	1.6	1 630	2 570	274		EE220975D/221575	1	292	381	360	6	6.4	1.6	0.39	1.71	2.54	1.67	56.4		
	406.400	215.900	219.075	6.4	3.2	3 490	6 250	612		HH249949D/HH249910	1-P	279	387	362	11	6.4	3.2	0.33	2.03	3.02	1.98	116		
254.000	355.600	92.710	92.862	3.2	1.6	1 090	1 850	203		EE171000D/171400	1	278	343	328	10	3.2	1.6	0.36	1.86	2.77	1.82	29.1		
	358.775	130.175	130.175	3.2	3.2	1 660	3 170	333		M249748D/M249710	1	277	346	330.1	8	3.2	3.2	0.33	2.03	3.02	1.98	42.1		
	368.300	92.710	92.862	3.2	1.6	1 090	1 850	203		EE171000D/171450	1	278	355	328	10	3.2	1.6	0.36	1.86	2.77	1.82	34.2		
	444.500	133.350	133.350	6.4	3.2	1 850	2 770	294		EE822101D/822175	1	311	425	393	7	6.4	3.2	0.42	1.62	2.42	1.59	86.9		

[Notes] 1) While metric series bearings have minus tolerances for bore and OD, inch series have plus tolerances. Refer to page 194 for details of applicable tolerance standards.

2) SP indicates the specially chamfered form.

Double-row tapered roller bearings

TDI type

d 260 ~ 299.974 mm

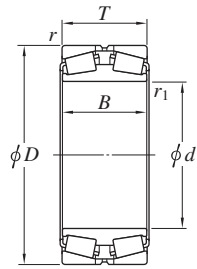

Design 1

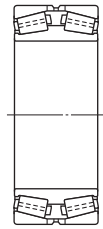

Design 1-P

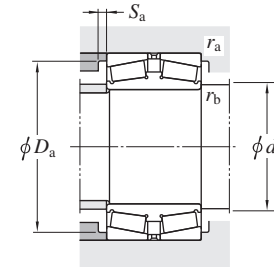

Boundary dimensions								Basic load ratings (kN)		Fatigue load limit (kN)	Design	Mounting dimensions (mm)						Constant	Axial load factors			(Refer.) Mass (kg)				
d mm	D mm	B mm	T mm	r min.	r_1 min.	C_r	C_{0r}	C_u	Bearing No. ¹⁾	d_a max.		D_a max.	S_a min.	r_a max.	r_b max.	e	Y_2	Y_3	Y_0							
260	—	400	—	104	—	104	—	4	5	1 320	2 120	227		45252	1	302	382	360	6	3	4	0.25	2.74	4.08	2.68	48.1
	—	400	—	150	—	150	—	4	5	2 050	3 540	371		45T524015	1	294	382	361	9	3	4	0.33	2.03	3.02	1.98	70.0
	—	420	—	170	—	170	—	4	5	2 700	4 260	440		45T524217	1	297	402	381.5	11.5	3	4	0.33	2.03	3.02	1.98	92.5
	—	440	—	144	—	144	—	4	5	2 180	3 440	357		45352	1	313	422	386	6	3	4	0.35	1.95	2.90	1.91	92.2
260.350	10.2500	365.125	14.3750	107.950	4.2500	107.950	4.2500	6.4	3.2	1 210	2 150	231		EE134102D/134143	1	283	346	334.7	8	6.4	3.2	0.37	1.80	2.69	1.76	34.4
	10.2500	400.050	15.7500	119.060	4.6874	114.300	4.5000	6.4	6.4	1 630	2 570	274		EE221025D/221575	1	292	381	360	6	6.4	6.4	0.39	1.71	2.54	1.67	51.8
	10.2500	422.275	16.6250	152.400	6.0000	139.700	5.5000	3.2	3.6	2 180	3 360	355		HM252347D/HM252310	1	306	409	385	1	3.2	3.6	0.33	2.03	3.02	1.98	78.8
	10.2500	422.275	16.6250	155.575	6.1250	152.400	6.0000	3.2	6.4	2 180	3 360	355		HM252348D/HM252310	1	304	409	385	1	3.2	6.4	0.33	2.03	3.02	1.98	81.5
	10.2500	431.724	16.9970	148.433	5.8438	152.400	6.0000	3.6	6.4	2 180	3 360	355		HM252348D/HM252315	1	304	418	385	4	3.6	6.4	0.33	2.03	3.02	1.98	87.1
266.700	10.5000	355.600	14.0000	107.950	4.2500	109.538	4.3125	3.2	1.6	1 300	2 550	267		LM451349D/LM451310	1	285	343	332	8	3.2	1.6	0.36	1.87	2.79	1.83	29.5
	10.5000	393.700	15.5000	130.175	5.1250	130.175	5.1250	6.4	3.2	1 590	3 090	325		EE275106D/275155	1	309	374	365	5	6.4	3.2	0.40	1.68	2.50	1.64	55.3
269.875	10.6250	381.000	15.0000	136.525	5.3750	136.525	5.3750	3.2	3.2	1 840	3 350	349		M252349D/M252310	1	291	368	351	6	3.2	3.2	0.33	2.03	3.02	1.98	48.4
276.225	10.8750	393.700	15.5000	130.175	5.1250	130.175	5.1250	6.4	1.6	1 590	3 090	325		EE275109D/275155	1	309	374	365	5	6.4	1.6	0.40	1.68	2.50	1.64	51.2
	10.8750	406.400	16.0000	122.240	4.8126	130.175	5.1250	6.4	1.6	1 590	3 090	325		EE275109D/275160	1	309	387	366	9	6.4	1.6	0.40	1.68	2.50	1.64	57.2
279.400	11.0000	393.700	15.5000	127.000	5.0000	127.000	5.0000	6.4	1.6	1 510	2 780	287		EE135111D/135155	1	305	374	361	9	6.4	1.6	0.38	1.77	2.64	1.73	48.9
	11.0000	457.200	18.0000	244.475	9.6250	244.475	9.6250	6.4	1.6	4 150	7 540	713		HH255149D/HH255110	1	315	438	407	11	6.4	1.6	0.33	2.03	3.02	1.98	166
279.578	11.0070	380.898	14.9960	117.475	4.6250	117.475	4.6250	3.2	1.6	1 420	2 820	286		LM654644D/LM654610	1	303	368	357	7	3.2	1.6	0.43	1.57	2.34	1.53	38.9
280	—	420	—	106	—	106	—	4	5	1 490	2 470	265		45256	1	321	402	370	6	3	4	0.25	2.69	4.00	2.63	51.9
285.750	11.2500	380.898	14.9960	117.475	4.6250	117.475	4.6250	3.2	1.6	1 420	2 820	286		LM654648D/LM654610	1	303	368	357	7	3.2	1.6	0.43	1.57	2.34	1.53	36.4
288.925	11.3750	406.400	16.0000	144.463	5.6875	144.463	5.6875	3.2	3.2	2 160	4 420	445		M255449D/M255410	1	316	394	374	8	3.2	3.2	0.34	2.00	2.97	1.95	61.4
292.100	11.5000	422.275	16.6250	130.175	5.1250	130.175	5.1250	3.2	6.4	1 980	3 410	358		EE330116D/330166	1	321	409	388	7	3.2	6.4	0.32	2.11	3.14	2.06	59.9
299.974	11.8100	438.048	17.2460	133.350	5.2500	134.938	5.3125	4.8	3.2	1 690	3 230	325		EE129119D/129172	1	339	422	401	7	4.8	3.2	0.40	1.68	2.50	1.64	68.7

[Note] 1) While metric series bearings have minus tolerances for bore and OD, inch series have plus tolerances. Refer to page 194 for details of applicable tolerance standards.

Double-row tapered roller bearings

TDI type

d 300 ~ 346.075 mm

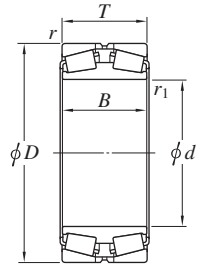

Design 1



Design 1-P

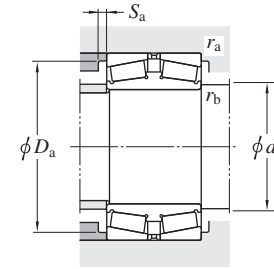

Boundary dimensions										Basic load ratings (kN)		Fatigue load limit (kN)	Design	Mounting dimensions (mm)						Constant	Axial load factors			(Refer.) Mass (kg)	
d mm	D mm	B mm	T mm	$r^{(2)}$ min.	$r_1^{(2)}$ min.	C_r	C_{0r}	C_u	Design	d_a max.	D_a max.	S_a min.		r_a max.	r_b max.	e	Y_2	Y_3	Y_0	Mass (kg)					
300	—	460	—	118	—	118	—	4		5	1 870	3 150	325	45260	1	350	442	418	6		3	4	0.25	2.74	4.08
	—	500	—	160	—	160	—	5	6	2 670	4 240	431	1		356	478	440	6	4	5	0.35	1.95	2.90	1.91	129
300.038	11.8125	422.275	16.6250	150.813	5.9375	150.813	5.9375	3.2	3.2	2 130	4 030	409	HM256849D/HM256810	1	324	408	389	7	3.2	3.2	0.34	2.00	2.98	1.96	66.2
303.213	11.9375	495.300	19.5000	263.525	10.3750	263.525	10.3750	6.4	3.2	5 020	9 340	858	HH258249D/HH258210	1-P	342	475	442	8	6.4	3.2	0.33	2.03	3.02	1.98	207
304.648	11.9940	438.048	17.2460	131.763	5.1875	131.763	5.1875	3.2	3.2	1 890	3 450	350	EE329117D/329172	1	337	424	400	10	3.2	3.2	0.33	2.04	3.04	2.00	65.9
304.800	12.0000	419.100	16.5000	130.175	5.1250	130.175	5.1250	6.4	1.6	1 770	3 480	350	M257149D/M257110	1	331	399	388	7	6.4	1.6	0.33	2.03	3.02	1.98	53.8
	12.0000	444.500	17.5000	111.125	4.3750	107.950	4.2500	1.6	7.9	1 550	2 760	288	EE291200D/291750	1	344	434	404	11	1.6	7.9	0.38	1.79	2.66	1.75	58.7
	12.0000	495.300	19.5000	171.450	6.7500	165.100	6.5000	6.4	3.2	2 740	4 680	461	EE724121D/724195	1	355	475	439	6	6.4	3.2	0.40	1.68	2.50	1.64	130
304.902	12.0040	412.648	16.2460	128.588	5.0625	128.588	5.0625	3.2	3.2	1 870	3 340	373	M257248D/M257210	1	330	399	386	6	3.2	3.2	0.32	2.12	3.15	2.07	48.8
305.003	12.0080	438.048	17.2460	133.350	5.2500	134.938	5.3125	4.8	3.2	1 690	3 230	325	EE129123D/129172	1	339	421	401	7	4.8	3.2	0.40	1.68	2.50	1.64	66.2
305.054	12.0100	499.948	19.6830	200.000	7.8740	200.000	7.8740	6.4	3.2	3 530	5 820	565	HM858548D/HM858511	1	343	480	447	10	6.4	3.2	0.49	1.36	2.03	1.33	157
317.500	12.5000	447.675	17.6250	158.750	6.2500	158.750	6.2500	3.3	1.6	2 400	4 770	465	HM259049D/HM259010	1	346	434	412	10	3.3	1.6	0.33	2.02	3.00	1.97	80.2
320	—	450	—	110	—	110	—	3	4	1 590	2 760	283	45T644511	1-P	352	436	416	5	2.5	3	0.38	1.77	2.64	1.73	54.1
	—	480	—	121	—	121	—	4	5	1 830	3 180	322	45264	1	368	462	434	6	3	4	0.26	2.55	3.80	2.50	77.8
	—	540	—	176	—	176	—	5	6	3 380	5 280	528	45364R	1	378	518	474	6	4	5	0.32	2.12	3.15	2.07	167
333.375	13.1250	469.900	18.5000	166.688	6.5625	166.688	6.5625	3.2	3.2	2 900	5 680	548	HM261049D/HM261010	1-P	360	456	433	8	3.2	3.2	0.33	2.02	3.00	1.97	92.8
340	—	580	—	190	—	190	—	5	6	3 790	5 470	537	45368	1	401	558	515	6	4	5	0.32	2.12	3.15	2.07	202
342.900	13.5000	533.400	21.0000	139.690	5.4996	146.050	5.7500	3.2	3.2	2 350	3 580	362	EE971355D/972100	1	392	520	483	8	3.2	3.2	0.33	2.03	3.02	1.98	113
343.052	13.5060	457.098	17.9960	120.650	4.7500	120.650	4.7500	SP	SP	1 780	3 470	340	45T694612	1	363	438	425	7	2	0.8	0.47	1.43	2.12	1.40	40.0
346.075	13.6250	488.950	19.2500	174.625	6.8750	174.625	6.8750	3.2	3.2	2 890	5 800	553	HM262749D/HM262710	1	378	475	450	8	3.2	3.2	0.33	2.02	3.00	1.97	105

[Notes] 1) While metric series bearings have minus tolerances for bore and OD, inch series have plus tolerances. Refer to page 194 for details of applicable tolerance standards.

2) SP indicates the specially chamfered form.

Double-row tapered roller bearings

TDI type

d 347.663 ~ 419.227 mm

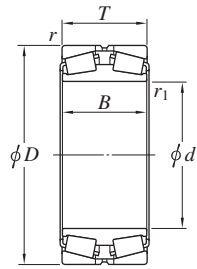

Design 1



Design 1-P

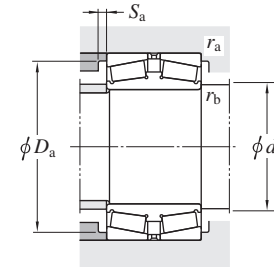

Boundary dimensions										Basic load ratings (kN)		Fatigue load limit (kN)	Bearing No. ¹⁾	Design	Mounting dimensions (mm)						Constant	Axial load factors			(Refer.) Mass (kg)	
d mm	D mm	B mm	T mm	$r^{2)}$ min.	$r_1^{2)}$ min.	C_r	C_{0r}	C_u		d_a max.	D_a max.	S_a min.			r_a max.	r_b max.	e	Y_2	Y_3	Y_0						
347.663	13.6875	469.900	18.5000	138.113	5.4375	138.113	5.4375	3.2	3.2	2 240	4 520	439		M262449D/M262410	1	374	456	437	9	3.2	3.2	0.33	2.03	3.02	1.98	70.0
355.600	14.0000	444.500	17.5000	112.713	4.4375	114.300	4.5000	3.2	1.6	1 390	3 450	332		L163149D/L163110	1	377	431	418	8	3.2	1.6	0.31	2.20	3.27	2.15	40.7
	14.0000	482.600	19.0000	133.350	5.2500	128.588	5.0625	3.2	1.6	1 910	3 510	346		LM763449D/LM763410	1	381	469	451	4	3.2	1.6	0.47	1.43	2.14	1.40	67.7
	14.0000	501.650	19.7500	127.000	5.0000	111.125	4.3750	3.2	3.2	1 700	3 280	322		EE231401D/231975	1	405	488	466	2	3.2	3.2	0.44	1.53	2.28	1.50	75.3
360	—	540	—	134	—	134	—	5	6	2 370	3 910	393		45272	1	408	518	488	11	4	5	0.32	2.12	3.15	2.07	101
	—	600	—	192	—	192	—	5	6	4 230	6 750	648		45372	1-P	419	578	528	10	4	5	0.32	2.12	3.15	2.07	228
368.300	14.5000	523.875	20.6250	185.738	7.3125	185.738	7.3125	6.4	3.2	3 420	6 780	644		HM265049D/HM265010	1-P	403	500	484	7	6.4	3.2	0.33	2.03	3.02	1.98	110
	14.5000	609.600	24.0000	254.000	10.0000	279.400	11.0000	6.4	3.2	5 420	9 060	813		EE321146D/321240	1	416	585	545	7	6.4	3.2	0.36	1.90	2.83	1.86	303
374.574	14.7470	546.100	21.5000	193.675	7.6250	193.675	7.6250	6.4	3.2	4 090	8 430	773		HM266445D/HM266410	1-P	418	525	505	10	6.4	3.2	0.33	2.03	3.02	1.98	163
380	—	560	—	135	—	135	—	5	6	2 300	3 790	371		45276	1	428	538	510	6	4	5	0.27	2.47	3.67	2.41	112
	—	570	—	200	—	200	—	4	1.5	4 020	7 560	697		45T765720	1-P	418	552	520	11.5	3	1.5	0.47	1.43	2.12	1.40	183
	—	620	—	194	—	194	—	5	6	3 860	6 360	606		45376	1	445	598	545	6	4	5	0.32	2.12	3.15	2.07	234
384.175	15.1250	546.100	21.5000	193.675	7.6250	193.675	7.6250	6.4	3.2	4 090	8 430	773		HM266449D/HM266410	1-P	418	525	505	10	6.4	3.2	0.33	2.03	3.02	1.98	155
393.700	15.5000	546.100	21.5000	141.288	5.5625	120.650	4.7500	6.4	3.2	1 860	3 810	357		EE234157D/234215	1	437	525	497.6	1	6.4	3.2	0.48	1.42	2.11	1.39	96.0
	15.5000	546.100	21.5000	138.113	5.4375	138.113	5.4375	6.4	1.6	2 300	4 700	445		LM767745D/LM767710	1	435	525	510	9	6.4	1.6	0.48	1.42	2.11	1.39	99.0
400	—	600	—	148	—	148	—	5	6	3 020	4 960	478		45280	1	452	578	545	6	4	5	0.33	2.03	3.02	1.98	143
	—	650	—	200	—	200	—	6	6	4 840	7 810	735		45380	1-P	458	622	580	11	5	5	0.39	1.74	2.59	1.70	265
400.000	15.7480	650.000	25.5906	250.000	9.8425	250.000	9.8425	SP	SP	5 860	9 790	868		45T806525	1-P	460	620	585	13	5	5	0.39	1.74	2.59	1.70	328
406.400	16.0000	546.100	21.5000	141.288	5.5625	120.650	4.7500	6.4	1.6	1 860	3 810	357		EE234161D/234215	1	437	520	497.6	1	6.4	1.6	0.48	1.42	2.11	1.39	88.6
	16.0000	546.100	21.5000	138.113	5.4375	138.113	5.4375	6.4	1.6	2 300	4 700	445		LM767749D/LM767710	1	435	520	510	9	6.4	1.6	0.48	1.42	2.11	1.39	90.5
415.925	16.3750	590.550	23.2500	209.550	8.2500	209.550	8.2500	6.4	3.2	4 240	8 930	803		M268749D/M268710	1-P	456	565	545	9	6.4	3.2	0.33	2.03	3.02	1.98	189
419.227	16.5050	736.448	28.9940	406.400	16.0000	406.400	16.0000	6.4	6.4	10 900	19 000	1 540		EE323166D/323290	1-P	480.1	710	655	9	6.4	6.4	0.37	1.80	2.69	1.76	752

[Notes] 1) While metric series bearings have minus tolerances for bore and OD, inch series have plus tolerances. Refer to page 194 for details of applicable tolerance standards.

2) SP indicates the specially chamfered form.

Double-row tapered roller bearings

TDI type

d 420 ~ 501.650 mm

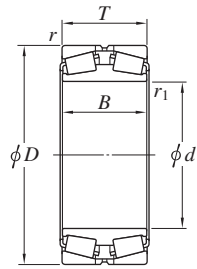

Design 1



Design 1-P

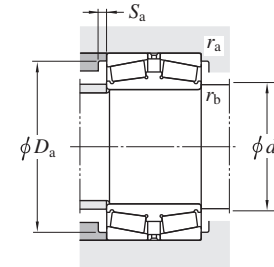

Boundary dimensions										Basic load ratings (kN)		Fatigue load limit	Bearing No. ¹⁾	Design	Mounting dimensions (mm)						Constant	Axial load factors			(Refer.) Mass (kg)	
<i>d</i>	<i>D</i>	<i>B</i>	<i>T</i>	<i>r</i>	<i>r</i> ₁	<i>C</i> _r	<i>C</i> _{0r}	<i>C</i> _u	<i>d</i> _a	<i>D</i> _a	<i>S</i> _a	<i>r</i> _a			<i>r</i> _b	<i>e</i>	<i>Y</i> ₂	<i>Y</i> ₃	<i>Y</i> ₀	Mass						
mm	1/25.4	mm	1/25.4	mm	1/25.4	mm	1/25.4	min.	min.			max.	max.	min.	min.	max.	max.									
420	—	700	—	224	—	224	—	6	6	5 430	8 380	777		45384	1-P	488	672	623	7	5	5	0.39	1.74	2.59	1.70	352
431.800	17.0000	635.000	25.0000	173.038	6.8125	173.038	6.8125	6.4	6.4	3 960	6 870	647		EE931170D/931250	1-P	482	610	585	8	6.4	6.4	0.32	2.10	3.13	2.06	189
431.902	17.0040	685.698	26.9960	254.000	10.0000	253.873	9.9950	6.4	3.2	6 420	11 600	1 000		EE328172D/328269	1-P	484	660	620	11	6.4	3.2	0.40	1.68	2.50	1.64	370
432.003	17.0080	609.524	23.9970	152.400	6.0000	152.400	6.0000	6.4	3.6	3 260	6 060	567		EE736173D/736238	1	473	585	565	8	6.4	3.6	0.35	1.95	2.90	1.91	135
440	—	650	—	157	—	157	—	6	6	3 190	5 500	512		45288	1	500	622	592	10	5	5	0.28	2.43	3.61	2.37	182
	—	720	—	226	—	226	—	6	6	5 750	9 130	834		45388	1-P	506	692	642	7	5	5	0.39	1.74	2.59	1.70	367
447.675	17.6250	635.000	25.0000	223.838	8.8125	223.838	8.8125	6.4	3.2	4 920	10 500	917		M270748D/M270710	1-P	491	610	585	8	6.4	3.2	0.33	2.03	3.02	1.98	234
	17.6250	635.000	25.0000	223.838	8.8125	223.838	8.8125	6.4	3.2	4 920	10 500	917		M270749D/M270710	1-P	491	610	585	8	6.4	3.2	0.33	2.03	3.02	1.98	234
457.200	18.0000	596.900	23.5000	133.350	5.2500	130.175	5.1250	3.2	1.6	2 410	5 230	486		EE244181D/244235	1	488	580	555	7	3.2	1.6	0.40	1.67	2.48	1.63	98.1
	18.0000	596.900	23.5000	136.525	5.3750	133.350	5.2500	3.2	1.6	2 420	5 110	476		L770849D/L770810	1	488	580	560	7	3.2	1.6	0.47	1.43	2.12	1.40	99.9
	18.0000	660.400	26.0000	155.572	6.1249	155.575	6.1250	6.4	3.2	2 900	5 260	482		EE737179D/737260	1	500	635	600	7	6.4	3.2	0.37	1.80	2.69	1.76	175
460	—	680	—	163	—	163	—	6	6	3 480	5 660	531		45292	1	510	652	616	6	5	5	0.39	1.74	2.59	1.70	197
479.425	18.8750	679.450	26.7500	238.125	9.3750	238.125	9.3750	6.4	3.2	5 200	10 800	924		57567	1	520	655	630	7	6.4	3.2	0.33	2.03	3.02	1.98	267
	18.8750	679.450	26.7500	238.125	9.3750	238.125	9.3750	6.4	3.2	5 310	11 100	952		M272749D/M272710	1-P	520	655	630	7	6.4	3.2	0.33	2.03	3.02	1.98	277
480	—	700	—	165	—	165	—	6	6	3 830	6 710	614		45296	1-P	531	672	625	6	5	5	0.40	1.68	2.50	1.64	215
482.600	19.0000	615.950	24.2500	158.750	6.2500	158.750	6.2500	6.4	3.2	3 040	7 110	639		LM272249D/LM272210	1	510	590	585	8	6.4	3.2	0.33	2.03	3.02	1.98	117
489.026	19.2530	634.873	24.9950	153.988	6.0625	153.988	6.0625	3.2	3.2	3 090	6 840	613		LM772749D/LM772710	1	510	620	595	9	3.2	3.2	0.47	1.43	2.12	1.40	126
500	—	720	—	167	—	167	—	6	6	4 300	7 350	681		452/500	1-P	545	692	645	8	5	5	0.39	1.74	2.59	1.70	222
	—	870	—	385	—	385	—	10	3.5	12 000	21 900	1 720		2TR500-4	1-P	518	826	765	9	8	3	0.33	2.03	3.02	1.98	1 030
501.65	—	711.2	—	250.825	—	250.825	—	6.4	3.2	5 890	12 400	1 040		2TR502	1	515	683	656	10	6.4	3.2	0.33	2.03	3.02	1.98	322
501.650	19.7500	711.200	28.0000	250.825	9.8750	250.825	9.8750	6.4	3.2	6 150	12 800	1 100		M274149D/M274110	1-P	545	685	655	10	6.4	3.2	0.33	2.03	3.02	1.98	323

[Note] 1) While metric series bearings have minus tolerances for bore and OD, inch series have plus tolerances. Refer to page 194 for details of applicable tolerance standards.

Double-row tapered roller bearings

TDI type

d 508.000 ~ 670 mm

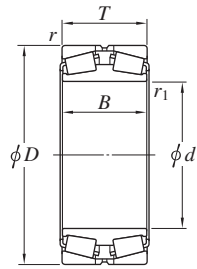

Design 1

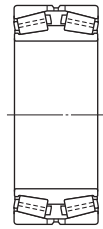

Design 1-P

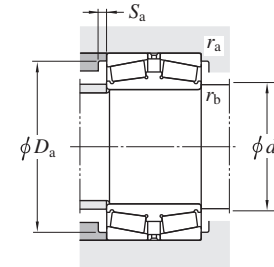

Boundary dimensions										Basic load ratings (kN)		Fatigue load limit (kN)	Design	Mounting dimensions (mm)						Constant	Axial load factors			(Refer.) Mass (kg)	
d mm	D mm	B mm	T mm	r min.	r_1 min.	C_r	C_{0r}	C_u	Bearing No. ¹⁾	d_a max.	D_a max.	S_a min.		r_a max.	r_b max.	e	Y_2	Y_3	Y_0	Mass					
508.000	20.0000	762.000	30.0000	219.075	8.6250	219.075	8.6250	6.4	6.4	5 690	9 970	888	EE531201D/531300	1-P	560	740	695	11	6.4	6.4	0.38	1.78	2.65	1.74	354
	20.0000	838.200	33.0000	266.700	10.5000	266.700	10.5000	9.5	6.4	7 160	11 700	1 000		1-P	580	810	755	7	9.5	6.4	0.48	1.41	2.10	1.38	585
510	—	655	—	184	—	184	—	6.4	1.5	3 970	9 590	829	2TR510-6	1	518	627	621	9	6.4	1.5	0.33	2.03	3.02	1.98	160
519.113	20.4375	736.600	29.0000	258.763	10.1875	258.763	10.1875	6.4	3.2	6 630	13 600	1 140	M275349D/M275310	1-P	560	710	680	10	6.4	3.2	0.33	2.03	3.02	1.98	361
520	—	735	—	111.125	—	260	—	5	6	6 630	13 600	1 140	2TR520C	1-P	548	713	681	11	4	5	0.33	2.03	3.02	1.98	356
530	—	780	—	185	—	185	—	6	6	5 100	8 870	788	452/530	1-P	591	752	710	8	5	5	0.39	1.74	2.59	1.70	306
	—	870	—	272	—	272	—	7.5	7.5	8 700	14 400	1 200		1-P	612	834	774	8	6	6	0.39	1.74	2.59	1.70	655
536.575	21.1250	761.873	29.9950	269.875	10.6250	269.875	10.6250	6.4	3.2	7 050	14 400	1 190	M276449D/M276410	1-P	575	740	700	9	6.4	3.2	0.33	2.03	3.02	1.98	401
540	—	710	—	150	—	140	—	4	5	3 310	6 620	599	2TR540	1-P	558	688	667	6	3	4	0.40	1.68	2.50	1.64	152
555.625	—	698.5	—	165.1	—	165.1	—	6.4	3.2	3 580	8 510	737	2TR555	1-P	569	670	662	10	6.4	3.2	0.33	2.03	3.02	1.98	151
558.800	22.0000	736.600	29.0000	196.850	7.7500	196.850	7.7500	6.4	3.2	4 500	9 870	854	LM377449D/LM377410	1-P	595	710	690	9	6.4	3.2	0.35	1.95	2.90	1.91	227
571.500	22.5000	812.800	32.0000	285.750	11.2500	285.750	11.2500	6.4	3.2	8 150	17 500	1 400	M278749D/M278710	1-P	620	790	750	11	6.4	3.2	0.33	2.03	3.02	1.98	497
595.313	23.4375	844.550	33.2500	296.863	11.6875	296.863	11.6875	6.4	3.2	8 500	18 500	1 460	M280049D/M280010	1-P	650	820	785	7	6.4	3.2	0.33	2.03	3.02	1.98	549
600	—	870	—	200	—	200	—	6	6	5 450	9 510	830	452/600	1-P	663	842	792	8	5	5	0.37	1.80	2.69	1.76	396
609.600	24.0000	787.400	31.0000	171.450	6.7500	171.450	6.7500	6.4	3.2	4 260	9 940	840	EE649241D/649310	1-P	645	760	740	12	6.4	3.2	0.37	1.82	2.70	1.78	223
630	—	1 030	—	315	—	315	—	7.5	7.5	11 500	19 400	1 540	453/630	1-P	733	994	915	8	6	6	0.39	1.74	2.59	1.70	1 060
635.000	25.0000	901.700	35.5000	317.500	12.5000	317.500	12.5000	6.4	3.2	9 370	19 900	1 540	M281049D/M281010	1-P	690	870	840	7	6.4	3.2	0.33	2.03	3.02	1.98	651
635	—	939.8	—	304.8	—	304.8	—	6.5	4	9 890	19 800	1 540	2TR635D	1-P	653	911	863	16	5	3	0.33	2.03	3.02	1.98	763
670	—	980	—	230	—	230	—	7.5	7.5	7 640	13 800	1 150	452/670	1-P	746	944	895	8	6	6	0.39	1.74	2.59	1.70	595

[Note] 1) While metric series bearings have minus tolerances for bore and OD, inch series have plus tolerances. Refer to page 194 for details of applicable tolerance standards.

Double-row tapered roller bearings

TDI type

d 685.800 ~ 939.800 mm

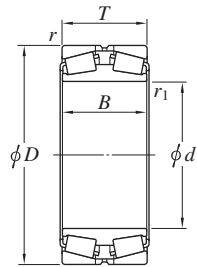

Design 1

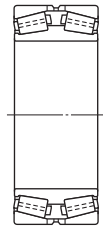

Design 1-P

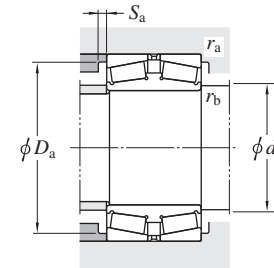

Boundary dimensions										Basic load ratings (kN)		Fatigue load limit	Bearing No. ¹⁾	Design	Mounting dimensions (mm)						Constant e	Axial load factors			(Refer.) Mass (kg)
d mm	D mm	B mm	T mm	r min.	r_1 min.	C_r	C_{0r}	(kN) C_u		d_a max.	D_a max.	S_a min.			r_a max.	r_b max.	Y_2	Y_3	Y_0						
685.800	27.0000	876.300	34.5000	171.450	6.7500	168.275	6.6250	6.4	3.2	4 400	10 800	880	EE655271D/655345	1-P	730	850	830	9	6.4	3.2	0.42	1.62	2.42	1.59	261
690	—	980	—	355	—	355	—	6	6	11 800	26 100	1 940	2TR690A	1-P	718	952	902	10	5	5	0.35	1.95	2.90	1.91	887
711.200	28.0000	914.400	36.0000	149.225	5.8750	149.225	5.8750	6.4	3.2	3 780	8 930	747	EE755281D/755360	1-P	770	890	870	8	6.4	3.2	0.38	1.78	2.65	1.74	256
714.375	28.1250	1 016.000	40.0000	339.725	13.3750	339.725	13.3750	6.4	3.2	12 200	26 100	1 940	M383240D/M383210	1-P	775	990	940	14	6.4	3.2	0.35	1.92	2.86	1.88	924
730.250	28.7500	1 035.050	40.7500	365.125	14.3750	365.125	14.3750	6.4	3.2	12 300	27 100	2 000	M283449D/M283410	1-P	790	1 010	960	10	6.4	3.2	0.33	2.03	3.02	1.98	1 000
749.300	29.5000	990.600	39.0000	293.000	11.5354	293.000	11.5354	6.4	3.2	9 820	23 900	1 780	LM283649D/LM283610	1-P	800	960	930	12	6.4	3.2	0.32	2.12	3.15	2.07	643
762.000	30.0000	1 079.500	42.5000	381.000	15.0000	381.000	15.0000	12.7	4.8	13 900	31 300	2 270	M284249D/M284210	1-P	830	1 040	1 000	11	12.7	4.8	0.33	2.03	3.02	1.98	1 140
800	—	1 100	—	300	—	300	—	6	3	9 550	21 700	1 570	2TR800A	1-P	814	1 072	1 016	12	5	2.5	0.80	0.85	1.26	0.83	863
810	—	1 280	—	430	—	430	—	9.5	4	18 500	38 600	2 670	2TR810A	1-P	828	1 236	1 166	21	8	3	0.41	1.66	2.47	1.62	2 250
825.500	32.5000	1 168.400	46.0000	409.575	16.1250	409.575	16.1250	12.7	4.8	16 300	36 200	2 550	M285848D/M285810	1-P	890	1 130	1 090	15	12.7	4.8	0.33	2.03	3.02	1.98	1 440
863.600	34.0000	1 130.300	44.5000	323.850	12.7500	323.850	12.7500	12.7	4.8	12 000	29 800	2 130	LM286249D/LM286210	1-P	920	1 090	1 070	15	12.7	4.8	0.32	2.08	3.10	2.04	896
	34.0000	1 219.200	48.0000	438.150	17.2500	425.450	16.7500	12.7	4.8	17 900	42 300	2 910	EE547341D/547480	1-P	940	1 180	1 130	9	12.7	4.8	0.33	2.03	3.02	1.98	1 660
939.800	37.0000	1 333.500	52.5000	463.550	18.2500	463.550	18.2500	12.7	4.8	21 000	47 700	3 210	LM287849D/LM287810	1-P	1 020	1 290	1 240	15	12.7	4.8	0.33	2.03	3.02	1.98	2 130

[Note] 1) While metric series bearings have minus tolerances for bore and OD, inch series have plus tolerances. Refer to page 194 for details of applicable tolerance standards.

Double-row tapered roller bearings for axial support

TDIS type

d 100 ~ 260.35 mm

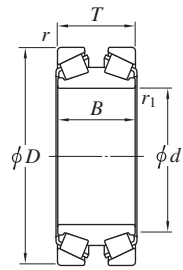

Design 1



Design 1-P

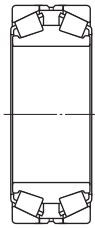

Design 2



Design 2-P



Design 3



Design 3-P

For oil mist lubrication

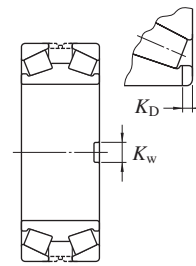

Face key way : A

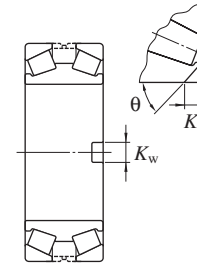

Face key way : B

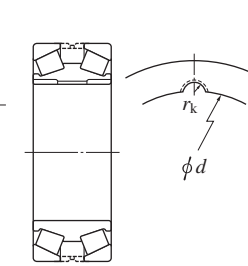

Bore key way

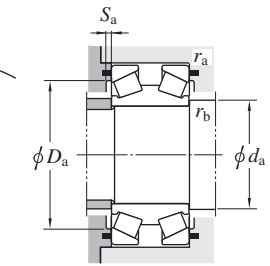

d	Boundary dimensions (mm)				Basic load ratings (kN)				Fatigue load limit (kN)		Bearing No. 1)	De- sign	Con- stant e	Axial load factors				Face key way				Bore key way Rk (mm)	Mounting dimensions (mm)					Mass (kg)			
	D	B	T	r min.	r1 3)	Cr	C0r	Cr	C0r	Cu (Radial)				Cu (Axial)	Y2	Y3	Y0	Type	Kw (mm)	KD (mm)	theta (deg)		qtyxPosition2)	da max.	Da max.	Da min.	Sa min.		ra max.	rb max.	
100	215	105	110	3	1	807	925	647	1 130	114	139	45T202211	2	0.81	0.84	1.25	0.82	B	20	18	45	2x2	—	119	184	163	5	2.5	1	18.3	
	249.1	120	120	3	2.5	898	1 040	805	1 430	127	174													45T202512	2	0.9	0.75	1.12	0.73		—
110	240	118	118	3	1	911	1 040	738	1 290	127	157	45T222412	2	0.81	0.83	1.23	0.81	—	—	—	—	—	—	129	204	180	6	2.5	1	25.2	
125	305	167	180	6.4	6	1 690	2 120	1 230	2 330	239	263	45T253018	2	0.73	0.93	1.38	0.91	—	—	—	—	—	—	173	261	233	8.5	5	5	65	
	305	180	180	6.4	6	1 690	2 120	1 230	2 330	239	263													45T253018-1	2	0.73	0.93	1.38	0.91		A
160	342.9	160	160	3.3	SP	1 860	2 410	1 500	2 940	261	320	45T323416-2	1	0.81	0.83	1.24	0.82	B	30	25	45	2x2	—	190	282	253	5	3	2.5	66	
170	360	144	160	4	5	1 680	2 100	1 820	3 440	225	371	45T303616-1	2	1.09	0.62	0.92	0.61	B	30	25	45	1x2	—	200	301	266	5	3	4	80	
	360	144	160	4	2.5	1 680	2 100	1 820	3 440	225	371													45T343616A	2	1.09	0.62	0.92	0.61		—
180	320	104	104	4	1.5	992	1 350	814	1 690	153	191	45T363210	2	0.83	0.82	1.22	0.8	—	—	—	—	—	—	212	278	259	7.5	3	1.5	35	
	190	320	104	104	3	4	987	1 400	783	1 690	160	194	45T383210	2	0.8	0.85	1.26	0.83	—	—	—	—	—	—	212	281	262	5	2.5	3	30
		320	104	104	3	4	987	1 400	783	1 690	160	194	45T383210A	1	0.8	0.85	1.26	0.83	B	40	15	45	1x2	—	212	281	262	5	2.5	3	33
320	114	114	4	2.5	1 110	1 570	954	2 070	175	229	45T383211A	2	0.87	0.78	1.16	0.76	A	38	10	—	1x2	—	216	282	260	6	3	2	33		
190.09	265	58	58	2.5	1.5	411	662	368	910	82.0	112	45T382706	1	0.9	0.75	1.12	0.73	A	8.5	4	—	1x2	—	210	242	231	4	2	1.5	9	
200	360	170	170	4	1.5	1 570	2 300	1 510	3 380	243	355	45T403617-1	2	0.96	0.7	1.04	0.68	A	30	17	—	2x2	—	230	307	270	—	3	1.5	65	
	380	180	180	4	SP	2 230	3 240	1 770	3 900	336	406	45T403818	2-P	0.8	0.85	1.26	0.83	B	30	25	45	1x2	—	236	328	294	5.5	3	3	94	
	380	180	180	4	SP	2 230	3 240	1 770	3 900	336	406	45T403818-1	2-P	0.8	0.85	1.26	0.83	B	30	25	45	2x2	—	236	328	294	5.5	3	3	94	
220	360	120	120	3	4	1 250	1 920	1 080	2 530	210	275	45T443612/DP	2	0.87	0.78	1.16	0.76	B	40	25	45	1x2	—	250	317	294	6.5	2.5	3	47	
228.6	431.8	177.8	177.8	6	SP	2 440	3 400	2 140	4 530	348	467	45T464318A-1	2-P	0.88	0.76	1.14	0.75	A	35	15	—	1x2	—	259	377	342	8.5	5	5	115	
240	460	140	140	5	6	1 760	2 570	1 520	3 380	267	350	45T484614	2-P	0.87	0.78	1.16	0.76	A	50	15	—	2x2	—	293	389	364	3	4	5	95	
260	459	155	155	4	5	1 980	2 780	1 700	3 650	289	379	45T524616	2-P	0.87	0.78	1.16	0.76	A	32.1	15	—	2x2	—	292	400	370	5.5	3	4	95	
260.35	419.1	155.575	158.75	3.2	3.2	2 210	3 710	1 320	3 370	378	344	45T524216	2	0.6	1.12	1.67	1.1	B	40.2	18	45	1x2	—	291	374	349	7.5	3	3	85	

[Notes] 1) Since there are many bearings of special tolerances for specific applications, consult with JTEKT for details of tolerances.

2) [x1]---one face, [x2]---both face.

3) SP indicates the specially chamfered form.

Double-row tapered roller bearings for axial support

TDIS type

d 273.05 ~ 320 mm

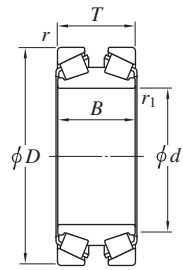

Design 1

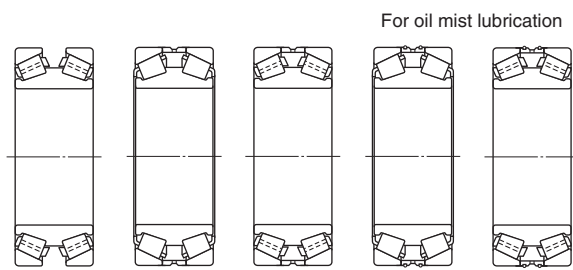

For oil mist lubrication

Design 1-P

Design 2

Design 2-P

Design 3

Design 3-P

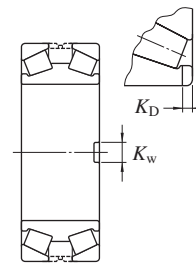

Face key way : A

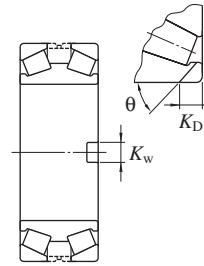

Face key way : B

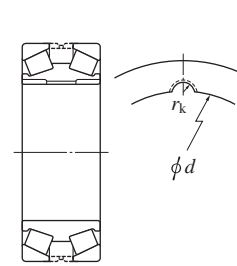

Bore key way

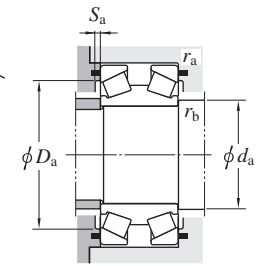

Boundary dimensions (mm)	Basic load ratings (kN)				Fatigue load limit (kN)		Bearing No. 1)	De-sign	Con-stant	Axial load factors				Face key way					Bore key way		Mounting dimensions (mm)					Mass (kg)				
	d	D	B	T	$r_{min.}$	$r_{1 min.}$ 3)				C_r	C_{0r}	C_r	C_{0r}	C_u (Radial)	(Axial)	e	Y_2	Y_3	Y_0	Type	K_w (mm)	K_D (mm)	θ (deg)	qty×Position ²⁾	R_k (mm)		d_a max.	D_a max.	D_a min.	S_a min.
273.05	393.7	130.175	130.175	6.4	1.6	1 480	2 760	1 030	2 930	281	298	45T553913	2	0.7	0.97	1.44	0.94	—	—	—	—	—	—	292	359	337	7.5	5	1.5	45
279.4	482.6	177.8	177.8	4.8	4.8	2 660	3 980	2 110	4 800	399	482	45T564818B	1-P	0.8	0.85	1.26	0.83	A	40	12	—	1×2	—	310	424	392	6.5	4	4	130
280	410	110	110	3	4	1 230	2 050	1 060	2 700	214	280	45T564111	2	0.87	0.78	1.16	0.76	—	—	—	—	—	—	308	371	350	5.5	2.5	3	48
285	380	92	92	2.5	1	952	1 820	820	2 400	192	252	45T573809B	1	0.87	0.78	1.16	0.76	B	32	13	45	1×2	—	303	352	334	5	2	1	28
298	419.5	120	120	4	2.5	1 370	2 440	1 180	3 210	250	328	45T604212-1	2	0.87	0.78	1.16	0.76	—	—	—	—	—	—	319	383	360	5	3	2	49
300	440	105	105	4	4	1 340	2 300	1 150	3 030	236	310	45T604411M	1-P	0.87	0.78	1.16	0.76	B	32.1	22.225	45	1×2	—	324	398	378	7.5	3	3	50
	440	105	105	3	4	1 220	2 480	1 050	3 260	248	326	45T604411N-1/DP1	2-P	0.87	0.78	1.16	0.76	B+C	32.131	22.225	45	—	6.477	334	395	374	6	2.5	3	57
	480	180	180	2.5	SP	2 230	4 300	1 920	5 650	408	535	45T604818	1	0.87	0.78	1.16	0.76	—	—	—	—	—	—	330	403	365	1	2	2.5	132
	500	160	160	5	SP	2 310	3 420	1 990	4 490	344	451	45T605016	1	0.87	0.78	1.16	0.76	B	52	25	45	1×2	—	327	439	410	7	4	5	110
	500	190	190	5	6	2 920	4 720	2 220	5 490	460	533	45T605019	1-P	0.76	0.88	1.31	0.86	B	50	30	45	1×2	—	339	440	405	3	4	5	142
	500	200	200	5	SP	2 920	4 720	2 220	5 490	460	533	45T605020-3	2-P	0.76	0.88	1.31	0.86	B	50	35	45	1×2	—	339	441	400	—	4	4	155
	520	180	180	5	SP	2 850	4 790	2 450	5 560	460	604	45T605218	1	0.87	0.78	1.16	0.86	B	50	30	45	2×2	—	340	443	408	8	4	4	151
570	290	290	6	SP	4 790	8 280	4 130	10 900	721	946	45T605729	2-P	0.87	0.78	1.16	0.76	B	50	35	45	1×2	—	332	479	418	0.5	5	3	347	
305	480	200	200	4	SP	2 580	4 670	2 220	6 140	441	578	45T614820-1	2	0.87	0.78	1.16	0.76	B	40	28	45	1×2	—	337	420	377	—	3	2.5	136
	500	200	200	5	6	2 920	4 720	2 220	5 490	460	533	45T615020	1-P	0.76	0.88	1.31	0.86	C	—	—	—	—	8.05	339	441	400	—	4	5	150
	500	200	200	5	6	2 920	4 720	2 220	5 490	460	533	45T615020-1	1-P	0.76	0.88	1.31	0.86	B	50.9	35	45	2×2	—	339	441	400	—	4	5	150
	500	200	200	5	6	2 920	4 720	2 220	5 490	460	533	45T615020B	1-P	0.76	0.88	1.31	0.86	B+C	50.9	35	45	1×2	8.05	339	441	400	—	4	5	150
	500	200	200	5	SP	2 920	4 720	2 220	5 490	460	533	45T615020D-2	1-P	0.76	0.88	1.31	0.86	C	51.3	35	45	1×2	8.05	339	441	400	—	4	4	146
	560	200	200	10	6.5	2 720	4 370	2 950	7 160	412	681	45T615620B	1	1.09	0.62	0.92	0.61	B	50.7	39.7	45	2×2	—	373	482	436	—	8	5	146
	560	200	200	20	6.5	2 720	4 370	2 950	7 160	412	681	45T615620D	1	1.09	0.62	0.92	0.61	A	50.8	19.05	—	2×2	—	373	482	436	—	10	5	146
318	449.5	120	120	4	2.5	1 370	2 420	1 430	3 850	246	391	45T644512	2	1.05	0.64	0.96	0.63	B	20	8.5	—	1×2	—	342	408	381	5.5	3	2	50
320	480	160	160	2.5	SP	2 030	4 090	1 750	5 380	391	514	45T644816A	1	0.87	0.78	1.16	0.76	B	51.3	22	45	2×1	—	349	419	386	5	2	2.5	101
	540	176	176	5	SP	2 860	4 810	2 460	6 330	464	608	45T645418	2-P	0.87	0.78	1.16	0.76	B	40	35	45	1×2	—	363	476	442	6.5	4	4	166
	560	200	200	4	2.5	3 790	6 040	2 060	4 990	586	485	45T645620	1-P	0.55	1.24	1.84	1.21	B	50	30	45	1×2	—	374	491	464	9.5	3	2	204

[Notes] 1) Since there are many bearings of special tolerances for specific applications, consult with JTEKT for details of tolerances.

2) [x1]...one face, [x2]...both face.
3) SP indicates the specially chamfered form.

Double-row tapered roller bearings for axial support

TDIS type

d 330 ~ (400) mm

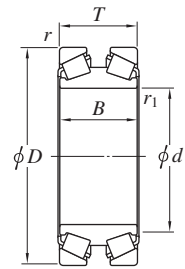

Design 1



Design 1-P

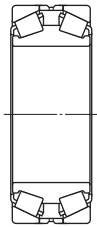

Design 2



Design 2-P



Design 3



Design 3-P

For oil mist lubrication

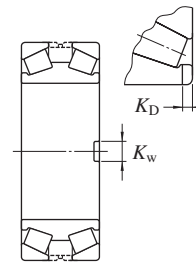

Face key way : A

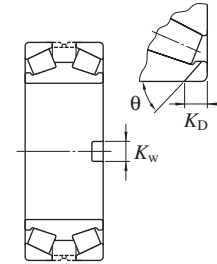

Face key way : B

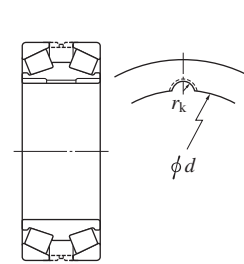

Bore key way

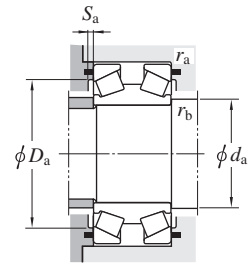

Boundary dimensions (mm)					Basic load ratings (kN)				Fatigue load limit (kN)		Bearing No. 1)	De-sign	Con-stant	Axial load factors				Face key way				Bore key way	Mounting dimensions (mm)					Mass (kg)		
d	D	B	T	$r^{3)}$ min.	$r_1^{3)}$ min.	C_r	C_{0r}	Radial	Axial	C_u				(Radial)	(Axial)	e	Y_2	Y_3	Y_0	Type	K_w (mm)	K_D (mm)	θ (deg)	qty×Position ²⁾	R_k (mm)	d_a max.	D_a max.		D_a min.	S_a min.
330	459	120	120	4	5	1 320	2 370	1 370	3 770	235	374	45T664612	2	1.05	0.64	0.96	0.63	A	32.1	12	—	2×2	—	354	421	393	5.5	3	4	55
	550	135	135	5	2	2 140	3 520	1 490	3 750	346	367	45T685514	2	0.7	0.97	1.44	0.94	B+C	36	26	45	1×2	9	390	483	463	7	4	2	123
340	590	192	192	SP	SP	3 700	5 870	2 580	6 240	559	592	45T685919-1	1-P	0.7	0.97	1.44	0.94	B	50	30	45	1×2	—	392	518	488	10	1	4	209
	345	550	200	270	6	4	3 040	5 740	2 620	7 550	529	694	45T695520	1	0.87	0.78	1.16	0.76	A	32	16	—	1×2	—	373	482	440	2	5	3
350	590	192	192	5	SP	3 540	5 590	3 050	7 360	529	694	45T705919A-1	1-P	0.87	0.78	1.16	0.76	A	32	12	—	1×2	—	398	522	486	9	4	5	200
	590	192	192	5	SP	3 180	6 570	3 450	10 800	577	952	45T705919D	1-P	1.09	0.62	0.92	0.61	A	32	12	—	1×2	—	401	520	470	11.5	4	5	227
	619	200	200	6	6	3 700	5 580	3 190	7 340	527	692	45T706220	2-P	0.87	0.78	1.16	0.76	A	50	20	—	2×2	—	396	539	502	4.5	5	5	260
360	570	148	148	5	6	2 410	3 900	1 680	4 150	385	408	45T725715	1	0.7	0.97	1.44	0.94	B	50	23	45	1×2	—	394	498	472	7	4	5	131
365.6	514.35	140	140	4	SP	1 740	3 730	1 500	4 910	348	456	45T735114A	1	0.87	0.78	1.16	0.76	B	40	20	45	2×2	—	394	457	428	5.5	3	2.5	89
374.65	501.65	120.65	130.175	6	3.3	1 590	3 160	1 370	4 160	303	397	45T755013A	1	0.87	0.78	1.16	0.76	B	50	10	—	1×2	—	399	463	436	2.5	5	3	67
380	550	255	205	SP	SP	3 570	7 340	1 940	6 070	665	550	45T765526	3-P	0.55	1.24	1.84	1.21	A	32	15	—	1×2	—	391	499	470	7.5	1	4	182
	560	190	190	2	2	3 580	7 220	1 950	5 970	661	547	45T765619	1-P	0.55	1.24	1.84	1.21	B	32	12	60	1×2	—	415	509	482	10.5	2	2	187
	560	200	200	4	4	3 440	7 020	2 070	6 440	641	588	45T765620	1-P	0.61	1.11	1.66	1.09	B	40.1	21	45	1×2	—	416	505	473	4	3	3	167
	570	200	200	4	SP	3 480	6 620	2 420	7 040	608	644	45T765720A	2-P	0.7	0.97	1.44	0.94	A	32	11.7	—	1×2	—	406	513	478	1.5	3	3	178
	650	240	240	6	5	4 810	8 260	3 820	9 950	723	874	45T766524	2-P	0.8	0.85	1.26	0.83	B	50	15	45	—	—	442	572	528	9.5	5	4	290
	650	240	240	6	SP	4 810	8 260	3 820	9 950	723	874	45T766524-2	2-P	0.8	0.85	1.26	0.83	B	50.5	40	45	2×2	—	442	572	528	9.5	5	5	335
381	695	280	280	6	SP	6 010	9 970	5 180	13 100	843	1 110	45T767028A	2-P	0.87	0.78	1.16	0.76	B	50	45	45	2×2	—	448	602	547	10	5	5	479
390	548	180	180	4	SP	2 570	5 540	2 220	7 290	496	650	45T765518	1	0.87	0.78	1.16	0.76	B	51.3	16	45	1×2	—	418	495	457	3	3	2.5	169
	562	180	180	4.5	SP	2 650	5 530	2 280	7 280	496	651	45T785618	1	0.87	0.78	1.16	0.76	A	32	11.7	—	2×2	—	420	501	463	4.5	4	2.5	145
	570	180	180	2.5	SP	2 650	5 530	2 280	7 280	496	651	45T785718A	1	0.87	0.78	1.16	0.76	B	51.3	22	45	2×2	—	420	501	463	4.5	2	2.5	149
	600	200	200	5	6	3 260	6 070	2 810	7 990	550	722	45T786020	2-P	0.87	0.78	1.16	0.76	—	—	—	—	—	7.5	424	539	500	2.5	4	5	202
400	600	148	148	5	6	2 280	4 040	1 770	4 750	379	448	45T806015A	1	0.78	0.86	1.29	0.85	B	50	25	45	1×2	—	432	531	505	9.5	4	5	131
	650	200	200	6	6	3 670	6 500	3 160	8 560	583	764	45T806520D	1	0.87	0.78	1.16	0.76	A	50.8	19	—	2×2	—	465	582	542	4.5	5	5	243
	650	240	240	6	SP	4 720	8 390	4 070	11 000	735	965	2TR400L	1-P	0.87	0.78	1.16	0.76	B	64.3	32	45	1×2	—	437	580	534	5.5	5	2	296

[Notes] 1) Since there are many bearings of special tolerances for specific applications, consult with JTEKT for details of tolerances.

2) [×1]---one face, [×2]---both face.

3) SP indicates the specially chamfered form.

Double-row tapered roller bearings for axial support

TDIS type

d (400) ~ 510 mm

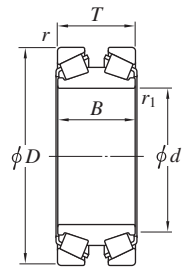

Design 1

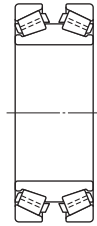

Design 1-P

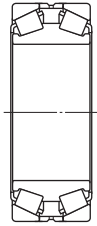

Design 2



Design 2-P

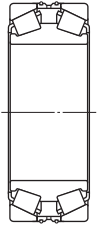

Design 3



Design 3-P

For oil mist lubrication

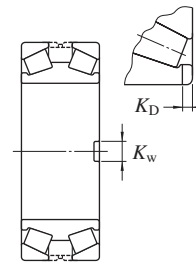

Face key way : A

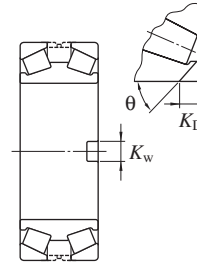

Face key way : B

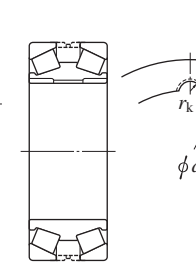

Bore key way

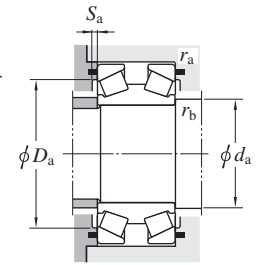

Boundary dimensions (mm)					Basic load ratings (kN)				Fatigue load limit (kN)		Bearing No. 1)	De-sign	Con-stant	Axial load factors				Face key way				Bore key way Rk (mm)	Mounting dimensions (mm)					Mass (kg)		
d	D	B	T	r ³⁾ min.	r ₁ ³⁾ min.	C _r	C _{0r}	C _r	C _{0r}	C _u (Radial)				C _u (Axial)	e	Y ₂	Y ₃	Y ₀	Type	K _w (mm)	K _D (mm)		θ (deg)	qty×Position ²⁾	R _k (mm)	d _a max.	D _a max.		D _a min.	S _a min.
400	650	240	240	6	SP	4 720	8 390	4 070	11 000	735	965	2TR400L-4/DP	3-P	0.87	0.78	1.16	0.76	B	64.3	32	45	1×2	—	437	580	534	5.5	5	2	308
406.4	546.1	138.112	138.112	6.4	SP	1 870	3 920	1 610	5 160	368	482	45T815514	1	0.87	0.78	1.16	0.76	A	50	11	—	1×2	—	436	502	474	5	5	3	89
410	580	160	160	4	7	2 730	5 430	904	7 140	530	267	45T825816A-1	2	0.87	0.78	1.16	0.76	A	50.8	10	—	1×2	—	434	532	500	9	3	5	133
430	535	84	84	3	SP	1 040	2 270	896	2 990	224	293	45T865408	2	0.87	0.78	1.16	0.76	B	20	15	45	1×2	—	456	503	486	5	2.5	2	42
	600	200	200	4	3	3 830	8 230	1 800	5 880	734	526	45T866020	1-P	0.47	1.43	2.12	1.4	A	50	19	45	1×2	—	466	552	527	6.5	3	2.5	172
440	650	155	155	6	SP	2 770	5 110	2 390	6 720	467	613	45T886516A	2-P	0.87	0.78	1.16	0.76	SP	50	15	45	1×2	—	484	593	564	8	5	4	172
445	620	160	160	4	2.5	2 660	5 060	2 290	6 650	467	612	45T896216	1-P	0.87	0.78	1.16	0.76	B	51.3	31.75	45	1×2	—	476	566	536	3.5	3	2	136
450	820	300	300	7.5	7.5	6 280	10 000	6 560	15 900	842	1 340	45T908230U	1-P	1.05	0.64	0.96	0.63	A	40	25	—	1×2	—	540	713	650	2.5	6	6	610
	830	320	320	7.5	7.5	7 000	10 900	7 310	17 200	895	1 420	45T908332-1	1-P	1.05	0.64	0.96	0.63	B	60	55	45	2×2	—	501	706	636	1	6	6	691
460	619	150	150	4	4	2 290	4 640	2 390	7 370	420	669	45T926215	2	1.05	0.64	0.96	0.63	A	50	15	—	2×2	—	486	569	536	4	3	3	125
470	700	270	270	5	SP	3 740	7 850	3 620	11 500	664	981	45T947027A	2	0.97	0.69	1.03	0.68	B	50	35	45	1×2	—	518	607	544	—	4	3	358
	720	216	216	6	6	4 130	7 360	4 480	12 100	650	1 070	45T947222/DP	3-P	1.09	0.62	0.92	0.61	B	63.6	30	45	1×2	—	515	646	600	7	5	5	309
482	655	160	170	4	4	2 370	5 270	2 040	6 930	463	608	45T966616-1	1	0.87	0.78	1.16	0.76	B	40	20	45	2×2	—	518	590	554	—	3	3	157
482.6	733.5	190	190	SP	SP	4 030	8 000	3 270	9 880	696	859	45T977319	1-P	0.81	0.83	1.23	0.81	B	64.2	44.45	45	1×2	—	547	669	635	7.5	2	2	283
	733.501	200.025	200	6.4	6.4	3 690	7 100	4 000	11 600	611	1 010	45T977320C	1-P	1.09	0.62	0.92	0.61	B+C	50.8	38.1	45	2×2	8.05	513	651	603	5	5	5	283
	733.501	200.025	200	17.5	6.4	3 690	7 100	4 000	11 600	611	1 010	45T977320D	1-P	1.09	0.62	0.92	0.61	A	50.8	19.05	—	2×2	—	513	651	603	5	10	5	280
	733.501	200.025	200	17.5	6.4	3 690	7 100	4 000	11 600	611	1 010	45T977320J	1-P	1.09	0.62	0.92	0.61	A	50.8	19.05	—	1×2	—	513	651	603	5	10	5	280
500	820	256	256	7.5	7.5	6 210	11 700	4 720	13 600	972	1 130	2TR500-3	2-P	0.76	0.88	1.31	0.86	B	50.8	38.1	45	2×2	—	561	718	672	9.5	6	6	559
	900	400	400	7.5	5	10 300	19 500	10 800	30 900	1 420	2 270	2TR500J	1-P	1.05	0.64	0.96	0.63	B	50	40	45	1×2	—	560	774	680	11	6	6	1 090
509.998	733.5	200.02	200.02	5	6	4 030	8 000	3 270	9 880	696	859	2TR510L-1	1-P	0.81	0.83	1.23	0.81	B	50.8	38.1	45	2×2	—	560	667	630	3.5	4	5	261
510	800	285	285	6	SP	6 730	12 300	5 340	14 800	995	1 200	2TR510-2	1-P	0.8	0.85	1.26	0.83	B	70.2	44.45	45	1×2	—	570	716	662	7	6	6	506

[Notes] 1) Since there are many bearings of special tolerances for specific applications, consult with JTEKT for details of tolerances.

2) [×1]---one face, [×2]---both face.

3) SP indicates the specially chamfered form.

Double-row tapered roller bearings for axial support

TDIS type

d 600 ~ 900 mm

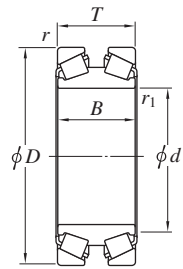

Design 1

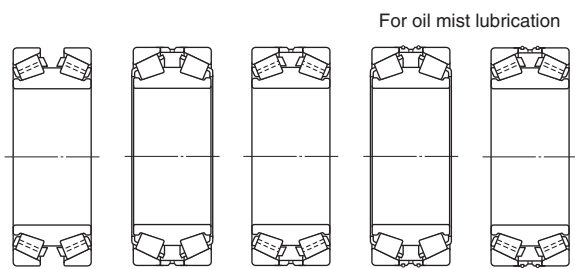

Design 1-P Design 2 Design 2-P Design 3 Design 3-P

For oil mist lubrication

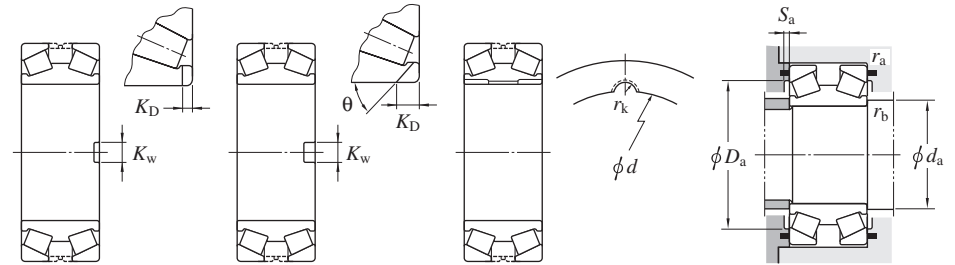

Face key way : A Face key way : B Bore key way

Boundary dimensions (mm)						Basic load ratings (kN)				Fatigue load limit (kN)		Bearing No. ¹⁾	De-sign	Con-stant	Axial load factors				Face key way				Bore key way R_k (mm)	Mounting dimensions (mm)						Mass (kg)
d	D	B	T	$r^{3)}$ min.	$r_1^{3)}$ min.	C_r	C_{0r}	Axial		C_u (Radial)	(Axial)				Type	K_w (mm)	K_D (mm)	θ (deg)	qty	Position ²⁾	d_a max.	D_a max.		D_a min.	S_a min.	r_a max.	r_b max.			
600	1 000	350	350	7.5	SP	10 600	18 500	8 020	21 500	1 410	1 640	2TR600-2	2-P	0.76	0.88	1.31	0.86	C	—	—	—	—	1.5	690	886	825	7.5	6	8	1 110
620	1 020	360	360	7.5	SP	10 600	19 800	9 100	26 100	1 480	1 940	2TR620	1-P	0.87	0.78	1.16	0.76	B	90	65	45	1×2	—	708	901	832	5	6	5	1 140
630	789	150	150	4	5	2 480	6 180	2 140	8 140	518	680	2TR630B	2-P	0.87	0.78	1.16	0.76	—	—	—	—	—	—	660	736	706	5	3	4	169
635	940	260	260	5.4	3.2	5 710	10 600	6 660	19 000	871	1 550	2TR635B-1	1-P	1.17	0.58	0.86	0.56	B	70.3	51	45	1×2	—	674	852	793	—	5	3	477
660	814	176.212	176.212	6.4	SP	3 280	8 780	2 280	9 340	709	752	2TR660C	1	0.7	0.97	1.44	0.94	B	50	20	45	1×2	—	686	766	735	5	5	2.5	196
685.8	939.8	235	228.6	SP	SP	6 160	12 800	4 690	14 900	1 030	1 190	2TR686A	1-P	0.76	0.88	1.31	0.86	B	63.6	38.5	45	1×2	—	730	868	827	8.5	1	3	455
	939.8	234.95	227.81	6.4	SP	5 500	13 000	4 740	17 200	1 020	1 340	2TR686C	1-P	0.87	0.78	1.16	0.76	B	80	38.1	45	2×2	—	745	865	819	6.5	5	3	464
717.55	1 000	200	200	6	SP	5 110	12 400	4 400	16 300	981	1 290	2TR718	1-P	0.87	0.78	1.16	0.76	B	70.3	44.5	45	1×2	—	800	914	874	9	5	5	482
780	1 000	200	200	5	2	5 130	12 800	4 070	15 400	1 010	1 220	2TR780A	1-P	0.8	0.85	1.26	0.83	B	90	35	45	1×2	—	830	937	900	8	4	2	381
900	1 220	300	300	12	3	9 950	23 200	8 580	30 500	1 640	2 150	2TR900-1	1-P	0.87	0.78	1.16	0.76	B	89.5	51	45	1×2	—	955	1 129	1 070	14	8	2.5	1 020

[Notes] 1) Since there are many bearings of special tolerances for specific applications, consult with JTEKT for details of tolerances.

2) [×1]...one face, [×2]...both face.

3) SP indicates the specially chamfered form.

Double-row tapered roller bearings (Tapered bore)

TDIT type

d 127.000 ~ 280.000 mm

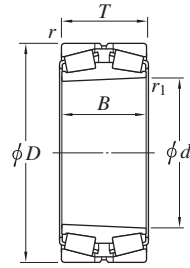

Design 1



Design 1-P

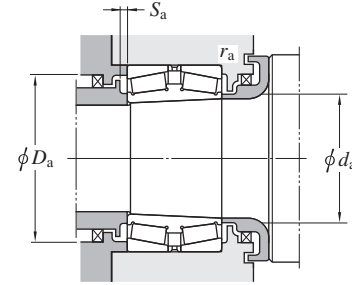

Boundary dimensions										Basic load ratings (kN)		Fatigue load limit	Bearing No. ¹⁾	Design	Mounting dimensions (mm)						Constant	Axial load factors			Mass (kg)
d	D	B	T	r	r_1	C_r	C_{0r}	C_u		d_a	D_a	S_a			r_a ²⁾	r_b ²⁾	e	Y_2	Y_3	Y_0					
mm	mm	mm	mm	mm	mm					max.	max.	min.	min.	max.											
127.000	182.563	76.200	76.200	3.2	1.6	487	858	120		141	171	166	3.8	3.2	1.6	0.31	2.21	3.29	2.16	6.57					
133.350	196.850	92.075	92.075	3.2	1.6	669	1 120	137		146	185	180	5	3.2	1.6	0.34	1.96	2.92	1.92	9.46					
136.525	215.900	123.825	123.825	3.2	1.6	691	1 100	132		154	204	193	5	3.2	1.6	0.49	1.38	2.06	1.35	15.9					
142.875	200.025	74.613	77.788	3.3	0.8	527	982	133		156	188	182	4	3.3	0.8	0.34	2.01	2.99	1.96	7.58					
147.638	241.300	132.334	133.351	3.2	1.6	904	1 460	171		166	229	211	7	3.2	1.6	0.44	1.53	2.27	1.49	23.6					
152.400	254.000	120.650	120.650	3.2	1.6	1 180	1 830	215		172	242	223	8	3.2	1.6	0.41	1.66	2.47	1.62	25.3					
165.100	269.875	146.050	146.050	3.2	1.6	1 430	2 220	252		187	258	243	5	3.2	1.6	0.33	2.03	3.02	1.98	32.2					
180.975	288.925	158.750	158.750	3.2	1.6	1 180	1 920	216		201	277	255	8	3.2	1.6	0.47	1.44	2.15	1.41	38.0					
	288.925	158.750	158.750	3.2	1.6	1 430	1 950	245		201	277	260	8	3.2	1.6	0.32	2.12	3.15	2.07	35.9					
190.500	365.049	152.400	158.750	3.2	3.2	2 020	2 920	319		239	353	317	6	3.2	3.2	0.40	1.68	2.50	1.64	77.2					
198.438	282.575	87.313	87.313	3.2	0.8	749	1 410	155		220	271	259	7	3.2	0.8	0.51	1.33	1.97	1.30	17.8					
209.550	317.500	184.150	184.150	3.2	1.6	1 300	2 270	244		223	306	278	7	3.2	1.6	0.52	1.29	1.92	1.26	48.3					
219.075	358.775	200.025	196.850	6.4	1.6	2 660	4 580	469		245	340	319	9	6.4	1.6	0.33	2.03	3.02	1.98	80.9					
222.250	355.600	130.175	127.000	3.2	1.6	1 410	2 630	278		253	343	312	8	3.2	1.6	0.59	1.14	1.70	1.12	50.9					
252.413	358.775	139.700	130.175	3.2	1.6	1 660	3 170	333		275	346	330	8	3.2	1.6	0.33	2.03	3.02	1.98	43.5					
263.525	400.050	192.088	196.848	6.4	1.6	1 630	2 570	274		292	381	359	6	6.4	1.6	0.39	1.71	2.54	1.67	76.7					
266.700	355.600	109.538	107.950	3.2	1.6	1 300	2 550	267		285	343	332	8	3.2	1.6	0.36	1.87	2.79	1.83	29.5					
280.000	406.400	206.375	206.375	3.2	3.2	1 650	2 950	307		308	394	368	7	3.2	3.2	0.39	1.75	2.61	1.71	81.4					

[Notes] 1) While metric series bearings have minus tolerances for bore and OD, inch series have plus tolerances. Refer to page 194 for details of applicable tolerance standards.

2) r_a indicates housing chamfer dimension corresponding to outer ring chamfer dimension r . r_b indicates the shaft chamfer dimension corresponding to inner ring chamfer dimension r_1 .

Double-row tapered roller bearings (Tapered bore)

TDIT type

d 288.925 ~ 519.113 mm

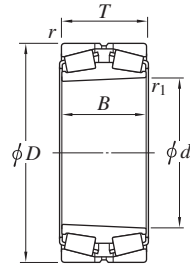

Design 1



Design 1-P

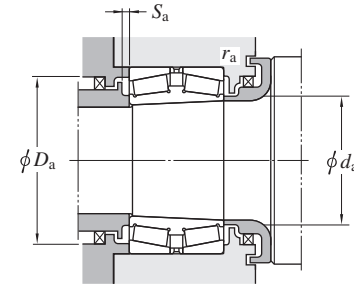

Boundary dimensions								Basic load ratings (kN)		Fatigue load limit	Bearing No. ¹⁾	Design	Mounting dimensions (mm)						Constant e	Axial load factors			Mass (kg)
d mm	D mm	B mm	T mm	r min.	r_1 min.	C_r	C_{0r}	(kN) C_u	d_a max.	D_a max.			S_a min.	r_a ²⁾ max.	r_b ²⁾ max.	Y_2	Y_3	Y_0					
288.925	406.400	144.463	144.463	3.2	3.2	2 160	4 420	445															
303.213	495.300	263.525	263.525	6.4	3.2	5 020	9 340	858															
333.375	469.900	166.688	166.688	3.2	3.2	2 900	5 680	548															
	523.875	185.738	185.738	6.4	3.2	3 420	6 780	644															
344.091	488.950	184.150	174.625	3.2	3.2	2 890	5 800	553															
346.075	488.950	174.625	174.625	3.2	3.2	2 890	5 800	553															
368.300	523.875	185.738	185.738	6.4	3.2	3 420	6 780	644															
384.175	546.100	193.675	193.675	6.4	3.2	4 090	8 430	773															
406.400	590.550	209.550	209.550	6.4	3.2	4 240	8 930	803															
415.925	590.550	209.550	209.550	6.4	3.2	4 240	8 930	803															
447.675	635.000	223.838	223.838	6.4	3.2	4 920	10 500	917															
479.425	679.450	238.125	238.125	6.4	3.2	5 310	11 100	952															
501.650	711.200	250.825	250.825	6.4	3.2	6 150	12 800	1 100															
519.113	736.600	258.763	258.763	6.4	3.2	6 630	13 600	1 140															

[Notes] 1) While metric series bearings have minus tolerances for bore and OD, inch series have plus tolerances. Refer to page 194 for details of applicable tolerance standards.

2) r_a indicates housing chamfer dimension corresponding to outer ring chamfer dimension r . r_b indicates the shaft chamfer dimension corresponding to inner ring chamfer dimension r_1 .

Double-row tapered roller bearings

TDO, TDOS type

d 100 ~ (120) mm

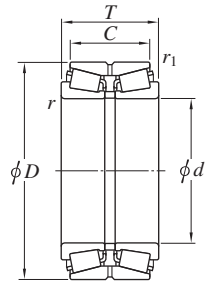

Design 1



Design 1-P



Design 2



Design 2-P

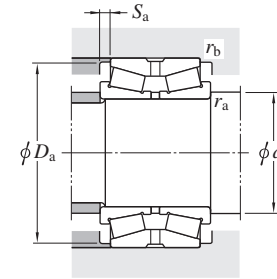

Boundary dimensions										Basic load ratings (kN)		Fatigue load limit (kN)	Bearing No. ¹⁾	Design	Mounting dimensions (mm)					Constant <i>e</i>	Axial load factors			(Refer.) Mass (kg)	
<i>d</i> mm	<i>D</i> mm	<i>T</i> mm	<i>C</i> mm	<i>r</i> ²⁾ min.	<i>r</i> ²⁾ min.	<i>C_r</i>	<i>C_{0r}</i>	<i>C_u</i>	<i>d_a</i> min.	<i>D_a</i> min.	<i>S_a</i> min.	<i>r_a</i> max.			<i>r_b</i> ²⁾ max.	<i>e</i>	<i>Y₂</i>	<i>Y₃</i>	<i>Y₀</i>						
100	—	150	—	46	—	37	—	2	0.6	226	293	42.6	46220A	1	110	142	4.5	2	0.6	0.35	1.95	2.90	1.91	2.53	
	—	165	—	52	—	46	—	2.5	0.6	249	305	44.1		46320	1	112	154	3	2	0.6	0.35	1.95	2.90	1.91	4.03
	—	165	—	65	—	52	—	2.5	0.6	333	443	64.7			46320A	1	112	153	6.5	2	0.6	0.35	1.95	2.90	1.91
	—	180	—	83	—	67	—	2.5	1	554	676	98.2		46T30220JR/67		1	114	168	8	2.5	1	0.42	1.61	2.39	1.57
	—	180	—	107	—	87	—	2.5	1	745	990	128			46T32220JR/87	1	114	171	10	2.5	1	0.42	1.61	2.39	1.57
	—	200	—	116	—	80	—	4	SP	743	941	118		46T202012		1	118	186	18	3	SP	0.63	1.07	1.59	1.04
100.000	3.9370	304.800	12.0000	184.160	7.2504	127.000	5.0000	SP	SP	1 490	1 630	187	46T203018	1	117	285	28	4	2	0.80	0.85	1.26	0.83	70.0	
105.000	4.1339	190.000	7.4803	88.000	3.4646	70.000	2.7559	SP	SP	530	632	84.0	46T211909	1	117	178	9	2	0.8	0.42	1.60	2.38	1.56	9.68	
105	—	190	—	88	—	70	—	2.5	1	618	761	105	46T30221JR/70	1	119	178	9	2.5	1	0.42	1.61	2.39	1.57	9.87	
	—	190	—	115	—	95	—	2.5	1	840	1 130	146		46T32221JR/95	1	119	180	10	2.5	1	0.42	1.61	2.39	1.57	13.5
110	—	170	—	45	—	40	—	2.5	0.6	219	304	42.5	46222	1	122	158	2.5	2	0.6	0.35	1.95	2.90	1.91	3.58	
	—	180	—	56	—	50	—	2.5	0.6	308	388	55.3		46322	1	122	168	3	2	0.6	0.35	1.95	2.90	1.91	5.13
	—	180	—	70	—	56	—	2.5	0.6	391	533	76.1	46322A		1	122	168	7	2	0.6	0.35	1.92	2.86	1.88	6.43
	—	180	—	94	—	72	—	2	0.6	504	761	107		46T221810	1	120	171	11	2	0.6	0.52	1.31	1.95	1.28	8.82
	—	180	—	125	—	100	—	2.5	0.6	676	1 070	136	46T221813-1		1	122	165	12.5	2	0.6	0.26	2.55	3.80	2.50	11.6
	—	200	—	92	—	74	—	2.5	1	695	868	116		46T30222JR/74	1	124	188	9	2.5	1	0.42	1.61	2.39	1.57	11.6
	—	200	—	121	—	101	—	2.5	1	938	1 280	161	46T32222JR/101		1	124	190	10	2.5	1	0.42	1.61	2.39	1.57	15.9
	—	220	—	145	—	115	—	3	1	1 130	1 430	180		46T222215	1	124	206	15	2.5	1	0.33	2.03	3.02	1.98	23.8
115	—	190	—	106	—	80	—	4	1.5	654	965	122	46T231911	1	133	177	13	3	1.5	0.42	1.62	2.42	1.59	10.7	
	—	230	—	116	—	84	—	3	SP	792	1 060	127		46T232312	1	129	219	16	2.5	1	0.73	0.92	1.37	0.90	20.9
120	—	180	—	46	—	41	—	2.5	0.6	232	317	43.6	46224	1	132	170	2.5	2	0.6	0.35	1.95	2.90	1.91	3.81	
	—	180	—	58	—	46	—	2.5	0.6	309	460	64.4		46224A	1	132	169	6	2	0.6	0.35	1.95	2.90	1.91	4.66
	—	200	—	62	—	55	—	2.5	0.6	367	470	65.7	46324		1	132	184	3.5	2	0.6	0.35	1.95	2.90	1.91	7.28
	—	200	—	78	—	62	—	2.5	0.6	486	672	93.9		46324A	1	132	185	8	2	0.6	0.35	1.95	2.90	1.91	9.14
	—	200	—	100	—	84	—	2.5	0.6	670	1 010	125	46324AS		1	132	190	8	2	0.6	0.35	1.95	2.90	1.91	12.0

[Notes] 1) While metric series bearings have minus tolerances for bore and OD, inch series have plus tolerances. Refer to page 194 for details of applicable tolerance standards.

2) SP indicates the specially chamfered form.

Double-row tapered roller bearings

TDO, TDOS type

d (120) ~ (130) mm

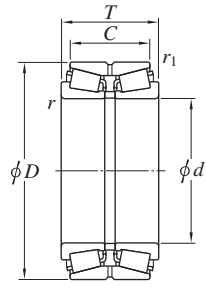

Design 1



Design 1-P



Design 2



Design 2-P

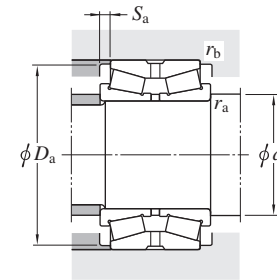

Boundary dimensions										Basic load ratings (kN)		Fatigue load limit (kN)	Bearing No. ¹⁾	Design	Mounting dimensions (mm)					Constant e	Axial load factors			(Refer.) Mass (kg)
d mm	D mm	T mm	C mm	$r^{(2)}$ min.	$r_1^{(2)}$ min.	C_r	C_{0r}	C_u	d_a min.	D_a min.	S_a min.	r_a max.			$r_b^{(2)}$ max.	e	Y_2	Y_3	Y_0					
120	—	215	—	97	—	78	—	2.5	1	745	945	123	46T30224JR/78 46T32224JR/109	1	134	203	9.5	2.5	1	0.44	1.55	2.31	1.52	13.9
	—	215	—	132	—	109	—	2.5	1	1 010	1 380	168		1	134	204	11.5	2.5	1	0.44	1.55	2.31	1.52	19.8
125	—	180	—	85	—	75	—	3	0.6	487	858	120	46T251809 46T252312 46T252414 46T252415	1	139	174	5	2.5	0.6	0.31	2.21	3.29	2.16	6.8
	—	230	—	116	—	84	—	4	SP	792	1 060	127		1	143	219	16	3	1	0.73	0.92	1.37	0.90	19.5
	—	235	—	142	—	114	—	SP	SP	1 120	1 650	200		1	137.2	217	14	2	SP	0.37	1.83	2.72	1.79	26.2
	—	235	—	145	—	115	—	4	1.5	1 120	1 650	200		1	143	217	15	3	1.5	0.37	1.83	2.72	1.79	26.4
127.000	5.0000	169.975	6.6919	58.738	2.3125	49.213	1.9375	1.6	1	282	501	69.6	L225849/L225812D 48290/48220D 67388/67322D 67388/67325D 74500/74851D 97500/97901D HM926747/HM926710D 95500/95927D	1	136	162	4.8	1.6	1	0.33	2.03	3.02	1.98	3.45
	5.0000	182.563	7.1875	85.725	3.3750	73.025	2.8750	3.6	0.8	487	858	120		1	140	174	6.4	3.6	0.8	0.31	2.21	3.29	2.16	6.95
	5.0000	196.850	7.7500	101.600	4.0000	85.725	3.3750	3.6	0.8	669	1 120	137		1	140	189	7.9	3.6	0.8	0.34	1.96	2.92	1.92	10.9
	5.0000	200.025	7.8750	101.600	4.0000	85.725	3.3750	3.6	0.8	669	1 120	137		1	140	189	7.9	3.6	0.8	0.34	1.96	2.92	1.92	11.6
	5.0000	215.900	8.5000	106.363	4.1875	80.963	3.1875	3.6	1.6	691	1 100	132		1	140	205	12.7	3.6	1.6	0.49	1.38	2.06	1.35	15.0
	5.0000	228.600	9.0000	115.888	4.5625	84.138	3.3125	3.6	2.4	700	918	111		1	140	213	15.9	3.6	2.4	0.74	0.92	1.36	0.90	17.8
	5.0000	228.600	9.0000	115.888	4.5625	84.138	3.3125	3.6	2.4	925	1 300	154		1	140	219	15.9	3.6	2.4	0.74	0.92	1.36	0.90	19.6
	5.0000	234.950	9.2500	142.875	5.6250	114.300	4.5000	6.4	1.6	1 120	1 650	200		1	145	217	14.3	6.4	1.6	0.37	1.83	2.72	1.79	25.8
127.792	5.0312	228.600	9.0000	115.888	4.5625	84.138	3.3125	3.6	2.4	925	1 300	154	HM926749/HM926710D	1	140	219	15.9	3.6	2.4	0.74	0.92	1.36	0.90	19.5
128.588	5.0625	206.375	8.1250	107.950	4.2500	82.550	3.2500	3.2	0.8	702	1 100	134		799/792D	1	140	195	12.7	3.2	0.8	0.46	1.47	2.19	1.44
130	—	180	—	69	—	55	—	2	0.6	404	663	92.1	46T261807 46226 46226A	1	140	174.9	7	2	0.6	0.33	2.03	3.02	1.98	4.77
	—	200	—	52	—	46	—	2.5	0.6	299	425	57.8		1	142	187	3	2	0.6	0.35	1.95	2.90	1.91	5.57
	—	200	—	65	—	52	—	2.5	0.6	400	618	85.0		1	142	185	6.5	2	0.6	0.35	1.95	2.90	1.91	7.06
130.000	5.1181	206.375	8.1250	107.950	4.2500	82.550	3.2500	3.6	0.8	702	1 100	134	797/792D	1	143	195	12.7	3.6	0.8	0.46	1.47	2.19	1.44	12.7
130	—	210	—	64	—	57	—	2.5	0.6	404	535	73.6	46326 46326A 46T262111 46T262112 46T30226JR/78.5	1	142	196	3.5	2	0.6	0.36	1.87	2.79	1.83	7.81
	—	210	—	80	—	64	—	2.5	0.6	513	723	99.3		1	142	198	8	2	0.6	0.36	1.87	2.79	1.83	9.57
	—	210	—	109	—	90	—	2.5	0.6	813	1 190	149		1	142	198	9.5	2	0.6	0.26	2.55	3.80	2.50	13.4
	—	214	—	115	—	98	—	2.5	1	838	1 220	152		1	142	204	8.5	2	1	0.33	2.03	3.02	1.98	15
	—	230	—	98	—	78.5	—	3	1	809	1 020	131		1	148	218	9.5	3	1	0.44	1.55	2.31	1.52	15.7

[Notes] 1) While metric series bearings have minus tolerances for bore and OD, inch series have plus tolerances. Refer to page 194 for details of applicable tolerance standards.

2) SP indicates the specially chamfered form.

Double-row tapered roller bearings

TDO, TDOS type

d (130) ~ (140) mm

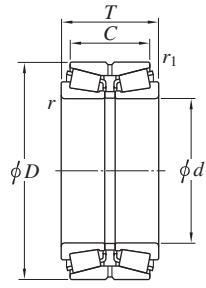

Design 1



Design 1-P



Design 2



Design 2-P

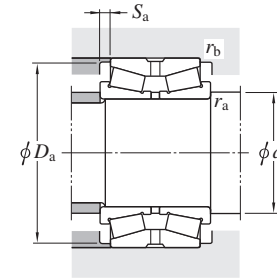

Boundary dimensions										Basic load ratings (kN)		Fatigue load limit (kN)	Bearing No. ¹⁾	Design	Mounting dimensions (mm)					Constant	Axial load factors			(Refer.) Mass (kg)
<i>d</i> mm	<i>D</i> mm	<i>T</i> mm	<i>C</i> mm	<i>r</i> min.	<i>r</i> ₁ min.	<i>C</i> _r	<i>C</i> _{0r}	<i>C</i> _u	<i>d</i> _a min.	<i>D</i> _a min.	<i>S</i> _a min.	<i>r</i> _a max.			<i>r</i> _b max.	<i>e</i>	<i>Y</i> ₂	<i>Y</i> ₃	<i>Y</i> ₀					
130	—	230	—	149	—	120	—	4	1	1 160	1 650	199	46T262315A 46T30326JR/107.5	1	148	222	14.5	3	1	0.43	1.57	2.34	1.53	24.2
	—	280	—	137	—	107.5	—	4	1.5	1 410	1 670	203		1	152	255	15	4	1.5	0.35	1.96	2.91	1.91	38.1
130.175	5.1250	196.850	7.7500	101.600	4.0000	85.725	3.3750	3.6	0.8	669	1 120	137	67389/67322D 799A/792D	1	143	189	7.9	3.6	0.8	0.34	1.96	2.92	1.92	10.4
	5.1250	206.375	8.1250	107.950	4.2500	82.550	3.2500	3.6	0.8	702	1 100	134		1	143	195	12.7	3.6	0.8	0.46	1.47	2.19	1.44	12.6
133	—	216	—	106	—	81	—	3	1	691	1 100	132	46T2622	1	147	205	12.5	2.5	1	0.49	1.38	2.06	1.35	14.1
133.350	5.2500	177.008	6.9688	57.150	2.2500	47.625	1.8750	1.6	0.8	302	557	76.4	L327249/L327210D	1	142	169	4.8	1.6	0.8	0.35	1.94	2.89	1.90	3.63
	5.2500	190.500	7.5000	85.725	3.3750	73.025	2.8750	3.6	0.8	505	944	129	48385/48320D	1	146	182	6.4	3.6	0.8	0.32	2.10	3.13	2.06	7.63
	5.2500	196.850	7.7500	101.600	4.0000	85.725	3.3750	3.6	0.8	669	1 120	137	67390/67322D	1	146	189	7.9	3.6	0.8	0.34	1.96	2.92	1.92	9.88
	5.2500	196.850	7.7500	101.600	4.0000	85.725	3.3750	7.9	0.8	669	1 120	137	67391/67322D	1	155	189	7.9	7.9	0.8	0.34	1.96	2.92	1.92	9.81
	5.2500	200.025	7.8750	101.600	4.0000	85.725	3.3750	3.6	0.8	669	1 120	137	67390/67325D	1	146	189	7.9	3.6	0.8	0.34	1.96	2.92	1.92	10.5
	5.2500	215.900	8.5000	106.363	4.1875	80.963	3.1875	3.6	1.6	691	1 100	132	74525/74851D	1	146	205	12.7	3.6	1.6	0.49	1.38	2.06	1.35	13.9
	5.2500	234.950	9.2500	142.875	5.6250	114.300	4.5000	9.5	1.6	1 120	1 650	200	95525/95927D	1	158	217	14.3	9.5	1.6	0.37	1.83	2.72	1.79	24.3
	5.2500	234.950	9.2500	142.875	5.6250	114.300	4.5000	4.7	1.6	1 120	1 650	200	95528/95927D	1	148	217	14.3	4.7	1.6	0.37	1.83	2.72	1.79	24.4
136.525	5.3750	190.500	7.5000	85.725	3.3750	73.025	2.8750	3.6	0.8	505	944	129	48393/48320D	1	149	182	6.4	3.6	0.8	0.32	2.10	3.13	2.06	7.18
	5.3750	215.900	8.5000	106.363	4.1875	80.963	3.1875	3.6	1.6	691	1 100	132	74537/74851D	1	149	205	12.7	3.6	1.6	0.49	1.38	2.06	1.35	13.4
	5.3750	228.600	9.0000	123.825	4.8750	98.425	3.8750	3.6	1.6	947	1 460	175	896/892D	1	149	215	12.7	3.6	1.6	0.42	1.60	2.39	1.57	19.2
139.700	5.5000	215.900	8.5000	106.363	4.1875	80.963	3.1875	3.6	1.6	691	1 100	132	74550/74851D	1	152	205	12.7	3.6	1.6	0.49	1.38	2.06	1.35	12.8
	5.5000	215.900	8.5000	106.363	4.1875	80.963	3.1875	6.4	1.6	691	1 100	132	74550A/74851D	1	158	205	12.7	6.4	1.6	0.49	1.38	2.06	1.35	12.8
	5.5000	228.600	9.0000	123.825	4.8750	98.425	3.8750	3.6	1.6	947	1 460	175	898/892D	1	152	215	12.7	3.6	1.6	0.42	1.60	2.39	1.57	18.5
	5.5000	228.600	9.0000	123.825	4.8750	98.425	3.8750	6.4	1.6	947	1 460	175	898A/892D	1	158	215	12.7	6.4	1.6	0.42	1.60	2.39	1.57	18.5
	5.5000	236.538	9.3125	131.763	5.1875	106.363	4.1875	3.6	1.6	904	1 460	171	82550/82932D	1	152	225	12.7	3.6	1.6	0.44	1.53	2.27	1.49	22.6
	5.5000	236.538	9.3125	131.763	5.1875	106.363	4.1875	3.6	1.6	1 080	1 660	198	HM231132/HM231111D	1	152	223	12.7	3.6	1.6	0.32	2.12	3.15	2.07	22.5
	5.5000	254.000	10.0000	149.225	5.8750	111.125	4.3750	7.1	1.6	1 180	1 830	215	99550/99102D	1	159	237	19.1	7.1	1.6	0.41	1.66	2.47	1.62	31.1
	5.5000	307.975	12.1250	200.025	7.8750	155.575	6.1250	9.5	2.4	2 180	2 900	331	HH234031/HH234011D	1	164	285	22.2	9.5	2.4	0.33	2.07	3.08	2.02	68.3
140	—	210	—	53	—	47	—	2.5	0.6	299	404	54.5	46228	1	152	196	3	2	0.6	0.33	2.03	3.02	1.98	5.85

[Note] 1) While metric series bearings have minus tolerances for bore and OD, inch series have plus tolerances. Refer to page 194 for details of applicable tolerance standards.

Double-row tapered roller bearings

TDO, TDOS type

d (140) ~ (150) mm

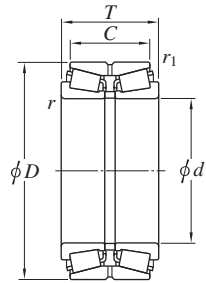

Design 1



Design 1-P



Design 2



Design 2-P

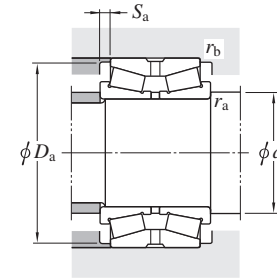

Boundary dimensions										Basic load ratings (kN)		Fatigue load limit (kN)	Bearing No. ¹⁾	Design	Mounting dimensions (mm)					Constant	Axial load factors			(Refer.) Mass (kg)	
<i>d</i>	<i>D</i>	<i>T</i>	<i>C</i>	<i>r</i>	<i>r</i> ₁	<i>C</i> _r	<i>C</i> _{0r}	<i>C</i> _u	<i>d</i> _a	<i>D</i> _a	<i>S</i> _a	<i>r</i> _a			<i>r</i> _b	<i>e</i>	<i>Y</i> ₂	<i>Y</i> ₃	<i>Y</i> ₀						
mm	mm	mm	mm	mm	mm	mm	mm	mm	min.	min.	mm	mm	mm	mm	mm	mm	mm	mm							
140	—	210	—	66	—	53	—	2.5	0.6	452	639	86.9		46228A	1	152	199	6.5	2	0.6	0.47	1.43	2.12	1.40	7.18
	—	225	—	68	—	61	—	3	1	423	564	76.1		46328	1	154	210	3.5	2.5	1	0.35	1.95	2.90	1.91	9.56
	—	225	—	85	—	68	—	3	1	597	836	113		46328A	1	154	212	8	2.5	1	0.35	1.95	2.90	1.91	11.8
	—	230	—	120	—	94	—	4	1	865	1360	162		46T282312	1	158	212	13	3	1	0.42	1.60	2.38	1.56	18.7
	—	230	—	140	—	110	—	3	1	1010	1480	177		46T282314	1	154	218	15	2.5	1	0.35	1.95	2.90	1.91	20.3
	—	240	—	132	—	106	—	4	1.5	904	1460	171		46T282413	1	158	225	13	3	1.5	0.44	1.53	2.27	1.49	23.6
	—	250	—	153	—	125.5	—	3	1	1360	1920	224		46T32228JR/125.5	1	158	238	14	3	1	0.44	1.55	2.31	1.52	30.2
	—	270	—	170	—	125	—	4	1	885	2130	132		46T282717	1	158	253	22.5	3	1	0.44	1.55	2.31	1.52	41.5
142.875	5.6250	200.025	7.8750	87.315	3.4376	73.025	2.8750	7.9	0.8	527	982	133		48684/48620D	1	164	191	7.1	7.9	0.8	0.34	2.01	2.99	1.96	7.98
	5.6250	200.025	7.8750	87.315	3.4376	73.025	2.8750	3.6	0.8	527	982	133		48685/48620D	1	156	191	7.1	3.6	0.8	0.34	2.01	2.99	1.96	8.06
	5.6250	236.538	9.3125	131.763	5.1875	106.363	4.1875	3.6	1.6	904	1460	171		82562/82932D	1	156	225	12.7	3.6	1.6	0.44	1.53	2.27	1.49	21.9
146.050	5.7500	193.675	7.6250	65.085	2.5624	53.975	2.1250	1.6	0.8	402	750	101		36690/36620D	1	155	186	5.6	1.6	0.8	0.37	1.83	2.73	1.79	4.96
	5.7500	193.675	7.6250	65.085	2.5624	53.975	2.1250	4.8	0.8	402	750	101		36691/36620D	1	161	186	5.6	4.8	0.8	0.37	1.83	2.73	1.79	4.93
	5.7500	236.538	9.3125	131.763	5.1875	106.363	4.1875	3.6	1.6	904	1460	171		82576/82932D	1	159	225	12.7	3.6	1.6	0.44	1.53	2.27	1.49	21.1
	5.7500	236.538	9.3125	131.763	5.1875	106.363	4.1875	3.6	1.6	1080	1660	198		HM231140/HM231111D	1	159	223	12.7	3.6	1.6	0.32	2.12	3.15	2.07	21.0
	5.7500	254.000	10.0000	149.225	5.8750	111.125	4.3750	7.1	1.6	1180	1830	215		99575/99102D	1	166	237	19.1	7.1	1.6	0.41	1.66	2.47	1.62	29.4
	5.7500	268.288	10.5625	160.338	6.3125	125.413	4.9375	6.4	1.6	1410	2090	239		EE107057/107105D	1	164	249	17.5	6.4	1.6	0.39	1.74	2.59	1.70	38.1
	5.7500	304.800	12.0000	135.733	5.3438	97.633	3.8438	3.2	1.6	1280	1600	195		EE750576/751204D	1-P	158	268	19.1	3.2	1.6	0.33	2.03	3.02	1.98	43.2
	149.225	5.8750	236.538	9.3125	131.763	5.1875	106.363	4.1875	3.6	1.6	904	1460		171		82587/82932D	1	162	225	12.7	3.6	1.6	0.44	1.53	2.27
5.8750		236.538	9.3125	131.763	5.1875	106.363	4.1875	6.4	1.6	1080	1660	198	HM231148/HM231111D	1		167	223	12.7	6.4	1.6	0.32	2.12	3.15	2.07	20.2
5.8750		236.538	9.3125	131.763	5.1875	106.363	4.1875	3.6	1.6	1080	1660	198	HM231149/HM231111D	1		162	223	12.7	3.6	1.6	0.32	2.12	3.15	2.07	20.3
150	—	225	—	56	—	50	—	3	1	348	476	63.2		46230	1	164	213	3	2.5	1	0.33	2.03	3.02	1.98	7.09
	—	225	—	70	—	56	—	3	1	472	703	94.1		46230A	1	164	213	7	2.5	1	0.33	2.03	3.02	1.98	8.82
	—	245	—	108	—	80	—	4	1.5	694	989	131		46T302511	1	168	227	14	3	1.5	0.35	1.93	2.88	1.89	17.2
	—	250	—	80	—	71	—	3	1	587	786	98.4		46330	1	164	233	4.5	2.5	1	0.35	1.95	2.90	1.91	14.6
	—	250	—	100	—	80	—	3	1	748	1070	132		46330A	1	164	234	10	2.5	1	0.35	1.95	2.90	1.91	17.6
	—	250	—	137	—	112	—	3	1	1030	1510	177		46T302514A	1	164	238	12.5	2.5	1	0.41	1.66	2.47	1.62	24.3

[Note] 1) While metric series bearings have minus tolerances for bore and OD, inch series have plus tolerances. Refer to page 194 for details of applicable tolerance standards.

Double-row tapered roller bearings

TDO, TDOS type

d (150) ~ 160.325 mm

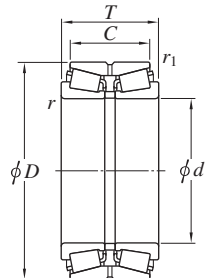

Design 1



Design 1-P



Design 2



Design 2-P

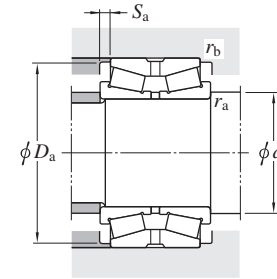

Boundary dimensions										Basic load ratings (kN)		Fatigue load limit (kN)	Bearing No. ¹⁾	Design	Mounting dimensions (mm)					Constant	Axial load factors			(Refer.) Mass (kg)
d mm	D mm	T mm	C mm	r min.	$r_1^{2)}$ min.	C_r	C_{0r}	C_u	e	Y_2	Y_3	Y_0			d_a min.	D_a min.	S_a min.	r_a max.	$r_b^{2)}$ max.					
150	—	250	—	140	—	115	—	3	SP	1 030	1 510	177	46T302514B 46T302514 46T302515 46T302615 46T30230JR/87 46T32230JR/130 46T302816	1	164	239	12	2.5	SP	0.41	1.66	2.47	1.62	28.0
	—	250	—	142	—	112	—	3	SP	1 030	1 510	177		1	164	237	15	2.5	SP	0.41	1.66	2.47	1.62	25.1
	—	250	—	145	—	115	—	4	1.5	1 030	1 510	177		1	168	239	15	3	1.5	0.41	1.66	2.47	1.62	25.7
	—	260	—	150	—	115	—	4	1.5	1 190	1 740	203		1	168	246	17.5	3	1.5	0.43	1.57	2.34	1.53	30.4
	—	270	—	109	—	87	—	3	1	1 040	1 330	162		1	168	255	11	3	1	0.44	1.55	2.31	1.52	24.6
	—	270	—	164	—	130	—	3	1	885	2 130	132		1	168	254	17	3	1	0.44	1.55	2.31	1.52	38
	—	280	—	160	—	104	—	4	1	1 300	1 730	197		1	168	265	28	3	1	0.81	0.83	1.23	0.81	38.7
150.813	5.9375	244.475	9.6250	107.950	4.2500	79.375	3.1250	3.6	1.6	694	989	131	81593/81963D	1	163	227	14.3	3.6	1.6	0.35	1.93	2.88	1.89	16.7
152.400	6.0000	222.250	8.7500	100.010	3.9374	76.200	3.0000	3.6	0.8	678	1 190	159	M231649/M231610D	1	165	210	11.9	3.6	0.8	0.33	2.03	3.02	1.98	11.9
	6.0000	244.475	9.6250	107.950	4.2500	79.375	3.1250	3.6	1.6	694	989	131	81600/81963D	1	165	227	14.3	3.6	1.6	0.35	1.93	2.88	1.89	16.4
	6.0000	254.000	10.0000	149.225	5.8750	111.125	4.3750	7.1	1.6	1 180	1 830	215	99600/99102D	1	172	237	19.1	7.1	1.6	0.41	1.66	2.47	1.62	27.7
	6.0000	268.288	10.5625	160.338	6.3125	125.413	4.9375	6.4	1.6	1 410	2 090	239	EE107060/107105D	1	171	249	17.5	6.4	1.6	0.39	1.74	2.59	1.70	36.2
	6.0000	307.975	12.1250	200.025	7.8750	146.050	5.7500	9.5	2.4	1 700	2 300	268	EE450601/451215D	1	177	275	27	9.5	2.4	0.33	2.07	3.09	2.03	61.6
	6.0000	307.975	12.1250	200.025	7.8750	155.575	6.1250	9.5	2.4	2 180	2 900	331	HH234048/HH234011D	1	177	285	22.2	9.5	2.4	0.33	2.07	3.08	2.02	63.7
155	—	330	—	180	—	120	—	6	1.5	1 860	2 410	261	46T313318A	1	183	315	30	5	1.5	0.81	0.83	1.24	0.82	70.0
158.750	6.2500	225.425	8.8750	85.725	3.3750	69.850	2.7500	3.6	0.8	554	1 140	148	46780R/46720D	1	171	215	7.9	3.6	0.8	0.38	1.76	2.62	1.72	10.7
160	—	240	—	60	—	53	—	3	1	405	565	74.0	46232 46232A 46332 46332A 46T322715 46T322815 46T32232JR/144	1	174	228	3.5	2.5	1	0.33	2.03	3.02	1.98	8.71
	—	240	—	75	—	60	—	3	1	508	756	99.6		1	174	226	7.5	2.5	1	0.33	2.03	3.02	1.98	10.6
	—	270	—	86	—	76	—	3	1	695	950	115		1	174	252	5	2.5	1	0.35	1.95	2.90	1.91	18.8
	—	270	—	108	—	86	—	3	1	871	1 270	150		1	174	252	11	2.5	1	0.35	1.95	2.90	1.91	23.1
	—	270	—	149	—	120	—	3	1	1 300	1 970	228		1	174	257	14.5	2.5	1	0.40	1.70	2.53	1.66	32.4
	—	280	—	150	—	125	—	4	1	1 370	2 000	231		1	178	262	12.5	3	1	0.32	2.12	3.15	2.07	36.2
	—	290	—	178	—	144	—	3	1	1 700	2 420	273		1	178	274	17	3	1	0.44	1.55	2.31	1.52	47.6
160.325	6.3120	288.925	11.3750	142.875	5.6250	111.125	4.3750	7.1	1.6	1 350	1 950	223	HM237532/HM237510D	1	180	271	15.9	7.1	1.6	0.32	2.12	3.15	2.07	37.2

[Notes] 1) While metric series bearings have minus tolerances for bore and OD, inch series have plus tolerances. Refer to page 194 for details of applicable tolerance standards.

2) SP indicates the specially chamfered form.

Double-row tapered roller bearings

TDO, TDOS type

d 165 ~ 175 mm

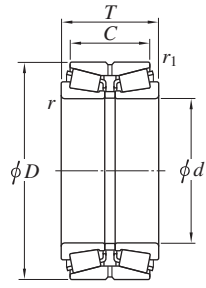

Design 1



Design 1-P



Design 2



Design 2-P

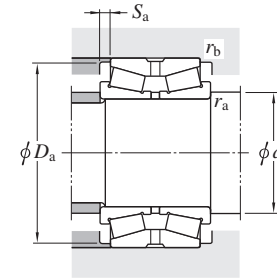

Boundary dimensions										Basic load ratings (kN)		Fatigue load limit (kN)	Bearing No. ¹⁾	Design	Mounting dimensions (mm)					Constant e	Axial load factors			(Refer.) Mass (kg)
d mm	D mm	T mm	C mm	$r^{2)}$ min.	$r_1^{2)}$ min.	C_r	C_{0r}	C_u		d_a min.	D_a min.	S_a min.			r_a max.	r_b max.	Y_2	Y_3	Y_0					
165	—	290	—	143	—	113	—	SP	1.5	1 180	1 950	216	46T332914	1	185	273	15	4	1.5	0.32	2.12	3.15	2.07	40.0
	—	290	—	150	—	125	—	6	1	1 470	2 140	249			46T332915	1	193	269	12.5	5	1	0.32	2.12	3.15
165.100	6.5000	215.900	8.5000	58.740	2.3126	47.625	1.8750	1.6	0.8	331	600	78.1	L433749/L433710D	1	174	207	5.6	1.6	0.8	0.36	1.85	2.76	1.81	5.06
	6.5000	225.425	8.8750	85.725	3.3750	69.850	2.7500	3.6	0.8	554	1 140	148	46790R/46720D	1	177.3	215	7.9	3.6	0.8	0.38	1.76	2.62	1.72	9.64
	6.5000	247.650	9.7500	103.188	4.0625	84.138	3.3125	3.6	0.8	741	1 400	160	67780/67720D	1	178	238	9.5	3.6	0.8	0.44	1.54	2.29	1.50	16.9
	6.5000	254.000	10.0000	101.600	4.0000	76.200	3.0000	4.8	1.6	815	1 240	162	M235145/M235113D	1	180	240	12.7	4.8	1.6	0.32	2.12	3.15	2.07	17.0
	6.5000	288.925	11.3750	142.875	5.6250	111.125	4.3750	7.1	1.6	1 180	1 920	216	94649/94114D	1	185	270	15.9	7.1	1.6	0.47	1.44	2.15	1.41	37.7
	6.5000	288.925	11.3750	142.875	5.6250	111.125	4.3750	7.1	1.6	1 430	2 090	245	HM237535/HM237510D	1	185	271	15.9	7.1	1.6	0.32	2.12	3.15	2.07	35.9
	6.5000	288.925	11.3750	146.050	5.7500	114.300	4.5000	7.1	1.6	1 430	2 090	245	HM237535/HM237511XD	1	185	271	15.9	7.1	1.6	0.32	2.12	3.15	2.07	36.5
168.275	6.6250	247.650	9.7500	103.188	4.0625	84.138	3.3125	3.6	0.8	741	1 400	160	67782/67720D	1	181	238	9.5	3.6	0.8	0.44	1.54	2.29	1.50	16.3
	6.6250	250.000	9.8425	103.190	4.0626	84.140	3.3126	SP	SP	880	1 410	185	46T342510	1	180.3	236	9.5	2	0.5	0.33	2.03	3.02	1.98	16.1
	6.6250	360.000	14.1732	190.000	7.4803	130.000	5.1181	SP	SP	2 020	2 570	280	46T343619	1	186.1	339	30	4	1	0.80	0.85	1.26	0.83	83.9
170.000	6.6929	254.000	10.0000	101.600	4.0000	76.200	3.0000	4.8	1.6	815	1 240	162	M235149/M235113D	1	185	240	12.7	4.8	1.6	0.32	2.12	3.15	2.07	16.0
170	—	260	—	67	—	60	—	3	1	480	642	83.4	46234	1	184	243	3.5	2.5	1	0.33	2.03	3.02	1.98	11.4
	—	260	—	84	—	67	—	3	1	629	969	125	46234A	1	184	244	8.5	2.5	1	0.33	2.03	3.02	1.98	14.7
	—	280	—	88	—	78	—	3	1	754	1 050	125	46334	1	184	263	5	2.5	1	0.33	2.06	3.06	2.01	19.8
	—	280	—	110	—	88	—	3	1	938	1 390	163	46334A	1	184	260	11	2.5	1	0.33	2.06	3.06	2.01	24.7
	—	310	—	195	—	150	—	5	1.5	2 020	2 790	316	46T343120-1	1	192	292	22.5	4	1.5	0.33	2.03	3.02	1.98	58.1
171.450	6.7500	288.925	11.3750	142.875	5.6250	111.125	4.3750	7.1	1.6	1 180	1 920	216	94675/94114D	1	191	270	15.9	7.1	1.6	0.47	1.44	2.15	1.41	35.9
174.625	6.8750	247.650	9.7500	103.188	4.0625	84.138	3.3125	7.9	0.8	741	1 400	160	67786/67720D	1	196	238	9.5	7.9	0.8	0.44	1.54	2.29	1.50	14.8
	6.8750	247.650	9.7500	103.188	4.0625	84.138	3.3125	3.6	0.8	741	1 400	160	67787/67720D	1	187	238	9.5	3.6	0.8	0.44	1.54	2.29	1.50	14.9
	6.8750	288.925	11.3750	142.875	5.6250	111.125	4.3750	7.1	1.6	1 180	1 920	216	94687/94114D	1	194	270	15.9	7.1	1.6	0.47	1.44	2.15	1.41	34.9
	6.8750	288.925	11.3750	142.875	5.6250	111.125	4.3750	7.1	1.6	1 350	1 950	223	HM237542/HM237510D	1	194	271	15.9	7.1	1.6	0.32	2.12	3.15	2.07	33.1
175	—	320	—	180	—	140	—	5	1.5	1 830	2 530	285	46T3532	1	197	301	20	4	1.5	0.32	2.12	3.15	2.07	56.7

[Notes] 1) While metric series bearings have minus tolerances for bore and OD, inch series have plus tolerances. Refer to page 194 for details of applicable tolerance standards.

2) SP indicates the specially chamfered form.

Double-row tapered roller bearings

TDO, TDOS type

d 177.800 ~ (187.325) mm

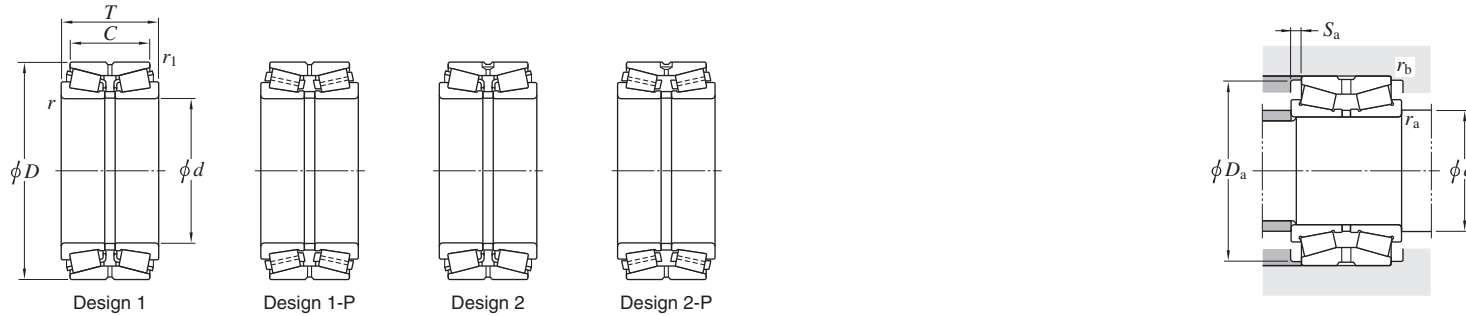

Boundary dimensions										Basic load ratings (kN)		Fatigue load limit (kN)	Bearing No. ¹⁾	Design ³⁾	Mounting dimensions (mm)					Constant	Axial load factors			(Refer.) Mass (kg)	
d mm	D mm	T mm	C mm	$r^{2)}$ min.	$r_1^{2)}$ min.	C_r	C_{0r}	C_u	d_a min.	D_a min.	S_a min.	r_a max.			$r_b^{2)}$ max.	e	Y_2	Y_3	Y_0						
177.800	7.0000	227.013	8.9375	66.672	2.6249	52.388	2.0625	1.6	0.8	381	805	102		36990/36920D	1	186	220	7.1	1.6	0.8	0.44	1.53	2.28	1.50	6.18
	7.0000	247.650	9.7500	103.188	4.0625	84.138	3.3125	3.6	0.8	741	1 400	160		67790/67720D	1	190	238	9.5	3.6	0.8	0.44	1.54	2.29	1.50	14.2
	7.0000	247.650	9.7500	103.188	4.0625	84.138	3.3125	10.4	0.8	741	1 400	160		67791/67720D	1	204	238	9.5	10.4	0.8	0.44	1.54	2.29	1.50	14.0
	7.0000	269.875	10.6250	119.063	4.6875	93.663	3.6875	3.6	1.6	880	1 610	183		M238840/M238810D	1	190	255	12.7	3.6	1.6	0.33	2.03	3.02	1.98	23.0
	7.0000	285.750	11.2500	136.525	5.3750	92.075	3.6250	6.4	1.6	956	1 430	165		EE91702/91113XD	1*	196	264	22.2	6.4	1.6	0.43	1.57	2.34	1.53	28.5
	7.0000	288.925	11.3750	142.875	5.6250	111.125	4.3750	7.1	1.6	1 180	1 920	216		94700/94114D	1	197	270	15.9	7.1	1.6	0.47	1.44	2.15	1.41	33.9
	7.0000	288.925	11.3750	142.875	5.6250	111.125	4.3750	7.1	1.6	1 350	1 950	223		HM237545/HM237510D	1	197	271	15.9	7.1	1.6	0.32	2.12	3.15	2.07	32.1
	7.0000	288.925	11.3750	146.050	5.7500	114.300	4.5000	7.1	1.6	1 350	1 950	223		HM237545/HM237511XD	1*	197	271	15.9	7.1	1.6	0.32	2.12	3.15	2.07	32.7
	7.0000	304.800	12.0000	147.838	5.8204	98.425	3.8750	6.4	1.6	1 220	1 600	199		EE280702/281201D	1	196	282	24.7	6.4	1.6	0.36	1.87	2.79	1.83	37.2
	7.0000	320.675	12.6250	185.738	7.3125	138.112	5.4375	3.6	1.6	1 610	2 450	271		EE222070/222127D	1	190	298	23.8	3.6	1.6	0.40	1.68	2.50	1.64	59.0
7.0000	320.675	12.6250	185.738	7.3125	138.113	5.4375	3.6	1.6	1 830	2 530	285		H239640/H239612D	1	190	301	23.8	3.6	1.6	0.32	2.12	3.15	2.07	56.6	
179.975	7.0856	317.500	12.5000	146.050	5.7500	111.125	4.3750	3.6	1.6	1 300	2 270	244		93708/93127D	1	193	295	17.5	3.6	1.6	0.52	1.29	1.92	1.26	47.2
	7.0856	319.976	12.5975	146.050	5.7500	111.125	4.3750	3.6	1.6	1 300	2 270	244		93708/93128XD	1*	193	295	17.5	3.6	1.6	0.52	1.29	1.92	1.26	48.3
180	—	280	—	74	—	66	—	3	1	582	801	98.9		46236	1	194	263	4	2.5	1	0.33	2.03	3.02	1.98	15.5
	—	280	—	93	—	74	—	3	1	732	1 080	131		46236A	1	194	261	9.5	2.5	1	0.33	2.03	3.02	1.98	19.0
	—	300	—	96	—	85	—	4	1.5	872	1 240	149		46336	1	198	277	5.5	3	1.5	0.33	2.06	3.06	2.01	25.8
	—	300	—	120	—	96	—	4	1.5	1 080	1 630	190		46336A	1	198	279	12	3	1.5	0.33	2.06	3.06	2.01	31.3
	—	300	—	163	—	134	—	4	1	1 520	2 240	255		46T363016	1	198	282	14.5	3	1	0.33	2.03	3.02	1.98	42.2
	—	320	—	127	—	99	—	4	1.5	1 330	1 740	202		46T30236JR/99	1	202	297	14	4	1.5	0.45	1.5	2.23	1.47	40.1
	—	320	—	192	—	152	—	4	1.5	2 060	3 030	328		46T32236JR/152	1	202	303	20	4	1.5	0.45	1.5	2.23	1.47	62.5
	—	340	—	170	—	140	—	5	1.5	1 920	2 530	285		46T363417	1	202	314	15	4	1.5	0.32	2.12	3.15	2.07	63.2
184.150	7.2500	266.700	10.5000	103.188	4.0625	84.138	3.3125	3.6	0.8	769	1 520	169		67883/67820D	1	197	257	9.5	3.6	0.8	0.48	1.41	2.11	1.38	18.7
184.15	—	288.925	—	142.88	—	111.12	—	SP	SP	1 220	1 920	214		46T372914	1	203.2	276	15.9	4	SP	0.40	1.68	2.50	1.64	31.7
187.325	7.3750	266.700	10.5000	103.188	4.0625	84.138	3.3125	3.6	0.8	769	1 520	169		67884/67820D	1	200	257	9.5	3.6	0.8	0.48	1.41	2.11	1.38	18.0
	7.3750	269.875	10.6250	119.063	4.6875	93.663	3.6875	3.6	1.6	880	1 610	183		M238849/M238810D	1	200	255	12.7	3.6	1.6	0.33	2.03	3.02	1.98	20.4
	7.3750	282.575	11.1250	107.950	4.2500	79.375	3.1250	3.6	1.6	880	1 450	182		87737/87112D	1	200	267	14.3	3.6	1.6	0.42	1.62	2.42	1.59	21.4

[Notes] 1) While metric series bearings have minus tolerances for bore and OD, inch series have plus tolerances. Refer to page 194 for details of applicable tolerance standards.

2) SP indicates the specially chamfered form.

3) * means no lubrication holes or grooves on double outer ring.

Double-row tapered roller bearings

TDO, TDOS type

d (187.325) ~ 200 mm

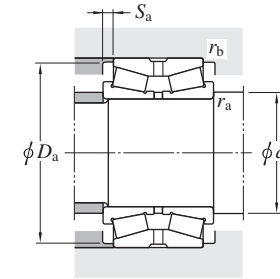
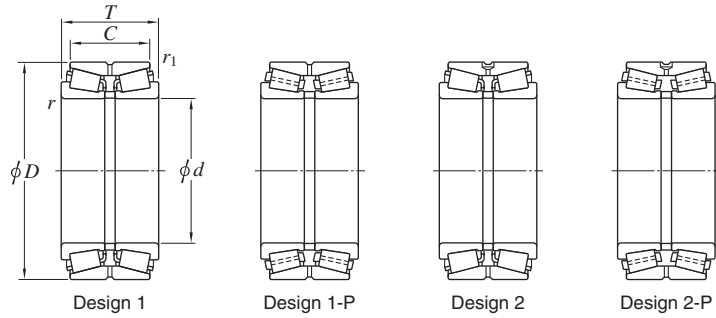

Boundary dimensions										Basic load ratings (kN)		Fatigue load limit (kN)	Bearing No. 1)	Design	Mounting dimensions (mm)					Constant e	Axial load factors			(Refer.) Mass (kg)
d mm	D mm	T mm	C mm	r min.	r_1 min.	C_r	C_{0r}	C_u	d_a min.	D_a min.	S_a min.	r_a max.			r_b max.	e	Y_2	Y_3	Y_0					
187.325	7.3750	320.675	12.6250	185.738	7.3125	138.113	5.4375	5.6	1.6	1 830	2 530	285	H239649/H239612D	1	204	301	23.8	5.6	1.6	0.32	2.12	3.15	2.07	52.6
190	—	290	—	75	—	67	—	3	1	610	866	106	46238	1	204	272	4	2.5	1	0.32	2.12	3.15	2.07	16.5
	—	290	—	94	—	75	—	3	1	793	1 170	140	46238A	1	204	274	9.5	2.5	1	0.33	2.03	3.02	1.98	20.0
	—	320	—	104	—	92	—	4	1.5	1 020	1 450	168	46338	1	208	298	6	3	1.5	0.35	1.95	2.90	1.91	31.9
	—	320	—	130	—	104	—	4	1.5	1 230	1 860	212	46338A	1	208	298	13	3	1.5	0.35	1.95	2.90	1.91	39.0
	—	320	—	171	—	134	—	4	1	1 870	2 800	314	46T383217C	2	208	301	18.5	3	1	0.32	2.12	3.15	2.07	51.0
	—	340	—	133	—	105	—	4	1.5	1 560	2 060	235	46T30238JR/105	1	212	318	14	4	1.5	0.44	1.55	2.31	1.52	47.8
	—	340	—	204	—	160	—	4	1.5	2 340	3 480	373	46T32238JR/160	1	212	323	22	4	1.5	0.44	1.55	2.31	1.52	75.1
190.500	7.5000	266.700	10.5000	103.188	4.0625	84.138	3.3125	3.6	0.8	769	1 520	169	67885/67820D	1	203	257	9.5	3.6	0.8	0.48	1.41	2.11	1.38	17.2
	7.5000	282.575	11.1250	107.950	4.2500	79.375	3.1250	3.6	1.6	880	1 450	182	87750/87112D	1	203	267	14.3	3.6	1.6	0.42	1.62	2.42	1.59	20.7
	7.5000	317.500	12.5000	146.050	5.7500	111.125	4.3750	4.3	1.6	1 300	2 270	244	93750/93127D	1	205	295	17.5	4.3	1.6	0.52	1.29	1.92	1.26	43.8
	7.5000	368.300	14.5000	193.675	7.6250	136.525	5.3750	6.4	1.6	2 020	2 920	319	EE420751/421451D	1	209	334	28.6	6.4	1.6	0.40	1.68	2.50	1.64	85.2
193.675	7.6250	282.575	11.1250	107.950	4.2500	79.375	3.1250	3.6	1.6	880	1 450	182	87762/87112D	1	206	267	14.3	3.6	1.6	0.42	1.62	2.42	1.59	19.8
196.850	7.7500	254.000	10.0000	61.910	2.4374	47.625	1.8750	1.6	0.8	404	773	96.5	L540049/L540010D	1	206	244	7.1	1.6	0.8	0.40	1.70	2.53	1.66	7.12
	7.7500	257.175	10.1250	85.725	3.3750	66.675	2.6250	3.6	0.8	576	1 260	157	LM739749/LM739710D	1	210	247	9.5	3.6	0.8	0.45	1.51	2.25	1.48	11.2
200	—	310	—	82	—	73	—	3	1	716	1 040	123	46240	1	214	288	4.5	2.5	1	0.32	2.12	3.15	2.07	21.4
	—	310	—	103	—	82	—	3	1	893	1 380	160	46240A	1	214	289	10.5	2.5	1	0.32	2.12	3.15	2.07	26.3
	—	310	—	152	—	123	—	3	1	1 630	2 670	293	46T403115	1	214	298	14.5	2.5	1	0.43	1.57	2.34	1.53	39.9
	—	310	—	170	—	140	—	3	1	1 550	2 730	297	46T4031	1	214	292	15	2.5	1	0.33	2.03	3.02	1.98	44.9
	—	320	—	146	—	110	—	5	1.5	1 300	2 270	244	46T403215	1	222	295	18	4	1.5	0.52	1.29	1.92	1.26	41.5
	—	330	—	180	—	140	—	4	1.5	1 680	2 690	295	46T403318	1	218	307	20	3	1.5	0.36	1.87	2.79	1.83	56
	—	340	—	112	—	100	—	4	1.5	1 100	1 580	180	46340	1	218	316	6	3	1.5	0.35	1.95	2.90	1.91	39.6
	—	340	—	140	—	112	—	4	1.5	1 350	2 040	226	46340A	1	218	319	14	3	1.5	0.35	1.95	2.90	1.91	48.2
	—	356	—	152	—	111	—	6	1.5	1 560	2 610	280	46T403615	1	209	333	20	5	1.5	0.33	2.04	3.04	2.00	61.6
	—	360	—	142	—	110	—	4	1.5	1 700	2 240	252	46T30240JR/110	1	222	336	16	4	1.5	0.44	1.55	2.31	1.52	56.5

[Note] 1) While metric series bearings have minus tolerances for bore and OD, inch series have plus tolerances. Refer to page 194 for details of applicable tolerance standards.

Double-row tapered roller bearings

TDO, TDOS type

d 200.025 ~ (220) mm

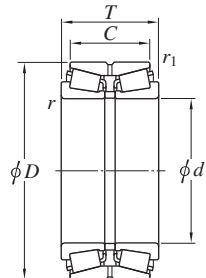

Design 1



Design 1-P



Design 2

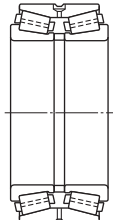

Design 2-P

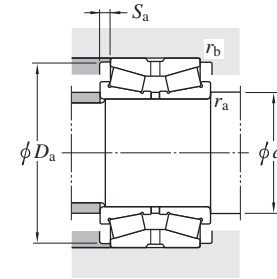

Boundary dimensions										Basic load ratings (kN)		Fatigue load limit (kN)	Bearing No. ¹⁾	Design	Mounting dimensions (mm)					Constant <i>e</i>	Axial load factors			(Refer.) Mass (kg)		
<i>d</i>	<i>D</i>	<i>T</i>	<i>C</i>	<i>r</i> ²⁾	<i>r</i> ₁ ²⁾	<i>C</i> _r	<i>C</i> _{0r}	<i>C</i> _u	<i>d</i> _a	<i>D</i> _a	<i>S</i> _a	<i>r</i> _a			<i>r</i> _b	<i>e</i>	<i>Y</i> ₂	<i>Y</i> ₃	<i>Y</i> ₀							
mm	1/25.4	mm	1/25.4	mm	1/25.4	mm	1/25.4	min.	min.			min.	max.	max.												
200.025	7.8750	317.500	12.5000	146.050	5.7500	111.125	4.3750	4.3	1.6	1 300	2 270	244			93787/93127D	1	215	294.5	17.5	4.3	1.6	0.52	1.29	1.92	1.26	40.5
	7.8750	355.600	14.0000	152.400	6.0000	111.125	4.3750	6.7	1.6	1 560	2 610	280			EE130787/131401D	1	220	330	20.6	6.7	1.6	0.33	2.04	3.04	2.00	61.8
	7.8750	384.175	15.1250	238.125	9.3750	193.675	7.6250	6.4	1.6	3 120	5 370	542			H247535/H247510D	1-P	219	362	22.2	6.4	1.6	0.33	2.03	3.02	1.98	126
203.200	8.0000	276.225	10.8750	90.485	3.5624	73.025	2.8750	3.6	0.8	804	1 430	179			LM241149/LM241110D	1	217	265	8.7	3.6	0.8	0.32	2.12	3.15	2.07	14.7
	8.0000	282.575	11.1250	101.600	4.0000	82.550	3.2500	3.6	0.8	749	1 410	155			67983/67920D	1	217	272	9.5	3.6	0.8	0.51	1.33	1.97	1.30	18.3
	8.0000	292.100	11.5000	125.415	4.9376	101.600	4.0000	3.6	1.6	1 170	2 050	230			M241547/M241510D	1	217	278	11.9	3.6	1.6	0.33	2.03	3.02	1.98	24.9
	8.0000	317.500	12.5000	146.050	5.7500	111.125	4.3750	4.3	1.6	1 300	2 270	244			93800/93127D	1	218	295	17.5	4.3	1.6	0.52	1.29	1.92	1.26	39.3
	8.0000	317.500	12.5000	146.050	5.7500	111.125	4.3750	7.9	1.6	1 300	2 270	244			93800A/93127D	1	225	295	17.5	7.9	1.6	0.52	1.29	1.92	1.26	39.2
	8.0000	368.300	14.5000	193.675	7.6250	136.525	5.3750	3.2	1.6	2 020	2 920	319			EE420801/421451D	1	216	334	28.6	3.2	1.6	0.40	1.68	2.50	1.64	79.4
	8.0000	406.400	16.0000	196.850	7.7500	127.000	5.0000	6.4	3.2	2 050	2 920	303			EE114080/114161D	1	222	368	34.9	6.4	3.2	0.79	0.85	1.27	0.83	105
	8.0625	292.100	11.5000	125.415	4.9376	101.600	4.0000	3.6	1.6	1 170	2 050	230			M241549/M241510D	1	218	278	11.9	3.6	1.6	0.33	2.03	3.02	1.98	24.4
206.375	8.1250	282.575	11.1250	101.600	4.0000	82.550	3.2500	3.6	0.8	749	1 410	155			67985/67920D	1	220	271.5	9.5	3.6	0.8	0.51	1.33	1.97	1.30	17.5
	8.1250	317.500	12.5000	127.000	5.0000	88.900	3.5000	4	1.6	944	1 450	166			EE132084/132126D	1	221	293	19.1	4	1.6	0.31	2.15	3.21	2.11	30.9
	8.1250	336.550	13.2500	211.138	8.3125	169.863	6.6875	3.2	1.6	2 230	3 800	400			H242649/H242610DC	2	219	318	20.6	3.2	1.6	0.33	2.03	3.02	1.98	69.7
209.550	8.2500	282.575	11.1250	101.600	4.0000	82.550	3.2500	3.6	0.8	749	1 410	155			67989/67920D	1	223	272	9.5	3.6	0.8	0.51	1.33	1.97	1.30	16.7
	8.2500	317.500	12.5000	146.050	5.7500	111.125	4.3750	4.3	1.6	1 300	2 270	244			93825/93127D	1	225	295	17.5	4.3	1.6	0.52	1.29	1.92	1.26	37.0
	8.2500	333.375	13.1250	149.225	5.8750	114.300	4.5000	6.4	1.6	1 520	2 480	265			HM743345/HM743310D	1	229	316	17.5	6.4	1.6	0.44	1.54	2.29	1.50	45.9
210	—	300	—	110	—	85	—	1	1	942	1 550	177			46T423011	1	224	287	12.5	1	1	0.38	1.78	2.64	1.74	21.8
212.725	8.3750	285.750	11.2500	98.425	3.8750	76.200	3.0000	3.6	0.8	766	1 560	190			LM742745/LM742710D	1	226	277	11.1	3.6	0.8	0.48	1.40	2.09	1.37	16.8
215.900	8.5000	285.750	11.2500	98.425	3.8750	76.200	3.0000	3.6	0.8	766	1 560	190			LM742749/LM742710D	1	230	277	11.1	3.6	0.8	0.48	1.40	2.09	1.37	15.9
	8.5000	406.400	16.0000	195.263	7.6875	147.638	5.8125	6.4	1.6	2 420	3 480	370			EE820085/820161D	1	235	372	23.8	6.4	1.6	0.39	1.71	2.55	1.67	103
219.075	8.6250	358.775	14.1250	196.850	7.7500	181.440	7.1433	SP	SP	2 080	3 590	376			46T443620	2	237.9	338	7.7	4	1	0.33	2.03	3.02	1.98	78.3
220	—	340	—	90	—	80	—	4	1.5	849	1 240	142			46244	1	238	319	5	3	1.5	0.32	2.12	3.15	2.07	27.8
	—	340	—	113	—	90	—	4	1.5	1 040	1 620	183			46244A	1	238	318	11.5	3	1.5	0.32	2.12	3.15	2.07	34.2

[Notes] 1) While metric series bearings have minus tolerances for bore and OD, inch series have plus tolerances. Refer to page 194 for details of applicable tolerance standards.

2) SP indicates the specially chamfered form.

Double-row tapered roller bearings

TDO, TDOS type

d (220) ~ 234.950 mm

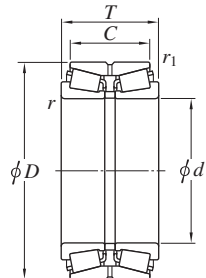

Design 1



Design 1-P



Design 2

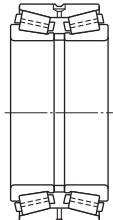

Design 2-P

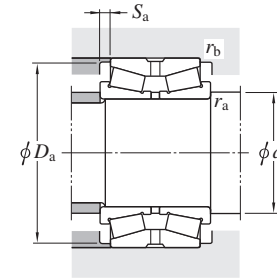

Boundary dimensions										Basic load ratings (kN)		Fatigue load limit (kN)	Bearing No. ¹⁾	Design	Mounting dimensions (mm)					Constant e	Axial load factors			(Refer.) Mass (kg)	
d mm	D mm	T mm	C mm	$r^{2)}$ min.	$r_1^{2)}$ min.	C_r	C_{0r}	C_u		d_a min.	D_a min.	S_a min.			r_a max.	r_b max.	Y_2	Y_3	Y_0						
220	—	370	—	120	—	107	—	5	1.5	1 260	1 810	202	46344 46344A 46T30244JR/114	1	242	346	6.5	4	1.5	0.35	1.95	2.90	1.91	49.1	
	—	370	—	150	—	120	—	5	1.5	1 600	2 470	272			1	242	343	15	4	1.5	0.35	1.95	2.90	1.91	60.1
	—	400	—	150	—	114	—	4	1.5	2 170	2 880	320			1	242	371	18	4	1.5	0.42	1.61	2.39	1.57	75.8
220.663	8.6875	314.325	12.3750	131.763	5.1875	106.363	4.1875	6.4	1.6	1 320	2 450	269	M244249/M244210D	1	240	299	12.7	6.4	1.6	0.33	2.03	3.02	1.98	30.5	
225.425	8.8750	355.600	14.0000	152.400	6.0000	111.125	4.3750	6.7	1.6	1 560	2 610	280	EE130889/131401D	1	245	330	20.6	6.7	1.6	0.33	2.04	3.04	2.00	51.8	
228.397	8.9920	431.800	17.0000	196.850	7.7500	111.125	4.3750	6.4	3.2	2 140	2 890	304	EE113089/113171D	1-P	248	397	42.9	6.4	3.2	0.88	0.76	1.14	0.75	111	
228.460	8.9945	431.800	17.0000	196.850	7.7500	111.125	4.3750	6.4	3.2	2 140	2 890	304	EE113091/113171D	1-P	248	397	42.9	6.4	3.2	0.88	0.76	1.14	0.75	111	
228.600	9.0000	327.025	12.8750	114.300	4.5000	82.550	3.2500	6.4	1.6	1 000	1 860	200	8573/8520D	1	248	310	15.9	6.4	1.6	0.41	1.66	2.47	1.62	28.2	
	9.0000	355.600	14.0000	152.400	6.0000	111.125	4.3750	7.1	1.6	1 410	2 630	278	96900/96140D	1	249	332	20.6	7.1	1.6	0.59	1.14	1.70	1.12	52.3	
	9.0000	355.600	14.0000	152.400	6.0000	111.125	4.3750	6.7	1.6	1 560	2 610	280	EE130902/131401D	1	248	330	20.6	6.7	1.6	0.33	2.04	3.04	2.00	50.4	
	9.0000	355.600	14.0000	152.400	6.0000	114.300	4.5000	6.4	1.6	1 660	2 740	295	HM746646/HM746610D	1	248	339	19.1	6.4	1.6	0.47	1.43	2.12	1.40	51.5	
	9.0000	358.775	14.1250	152.400	6.0000	117.475	4.6250	3.6	1.6	1 660	3 170	333	M249732/M249710D	1	242	343	17.5	3.6	1.6	0.33	2.03	3.02	1.98	56.4	
	9.0000	400.050	15.7500	187.325	7.3750	136.525	5.3750	10.4	1.6	2 130	3 210	338	EE430900/431576D	1	256	374	25.4	10.4	1.6	0.44	1.54	2.29	1.50	87.4	
	9.0000	425.450	16.7500	209.550	8.2500	158.750	6.2500	7.1	1.6	2 530	3 950	411	EE700091/700168D	1	249	382	25.4	7.1	1.6	0.33	2.03	3.02	1.98	123	
	9.0000	488.950	19.2500	345.000	13.5827	220.000	8.6614	SP	SP	4 560	7 010	614	46T464935B	1-P	246.6	465	62.5	4	1	0.94	0.72	1.07	0.70	298	
230	—	380	—	200	—	160	—	4	1	2 440	4 070	430	46T463820	1	248	354	20	3	1	0.26	2.55	3.80	2.50	86.1	
	—	410	—	180	—	120	—	5	1.5	2 210	3 060	340	46T464118	1	252	381	30	4	1.5	0.55	1.23	1.82	1.20	89.5	
	—	420	—	200	—	160	—	5	1.5	2 460	3 630	380	46T464220	2	252	391	20	4	1.5	0.47	1.43	2.12	1.40	114	
	—	430	—	215	—	130	—	6	1.5	2 580	3 700	373	46T464322A	1-P	258	410	42.5	5	1.5	0.94	0.72	1.07	0.70	126	
231.775	9.1250	358.775	14.1250	152.400	6.0000	117.475	4.6250	6.4	1.6	1 660	3 170	333	M249734/M249710D	1	251	343	17.5	6.4	1.6	0.33	2.03	3.02	1.98	55.0	
234.950	9.2500	327.025	12.8750	114.300	4.5000	82.550	3.2500	6.4	1.6	1 000	1 860	200	8575/8520D	1	254	310	15.9	6.4	1.6	0.41	1.66	2.47	1.62	26.2	
	9.2500	355.600	14.0000	152.400	6.0000	111.125	4.3750	7.1	1.6	1 410	2 630	278	96925/96140D	1	256	332	20.6	7.1	1.6	0.59	1.14	1.70	1.12	49.5	
	9.2500	384.175	15.1250	238.125	9.3750	193.675	7.6250	6.4	1.6	3 120	5 370	542	H247548/H247510D	1-P	254	362	22.2	6.4	1.6	0.33	2.03	3.02	1.98	104	
	9.2500	384.175	15.1250	238.125	9.3750	193.675	7.6250	6.4	1.6	3 120	5 370	542	H247549/H247510D	1-P	254	362	22.2	6.4	1.6	0.33	2.03	3.02	1.98	104	

[Notes] 1) While metric series bearings have minus tolerances for bore and OD, inch series have plus tolerances. Refer to page 194 for details of applicable tolerance standards.

2) SP indicates the specially chamfered form.

Double-row tapered roller bearings

TDO, TDOS type

d 237.330 ~ (254.000) mm

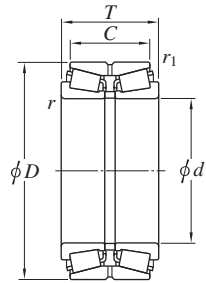

Design 1



Design 1-P



Design 2



Design 2-P

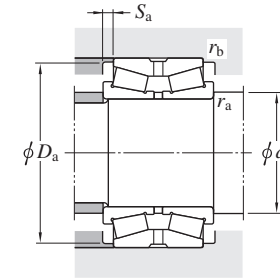

Boundary dimensions										Basic load ratings (kN)		Fatigue load limit (kN)	Bearing No. ¹⁾	Design	Mounting dimensions (mm)					Constant e	Axial load factors			(Refer.) Mass (kg)	
d mm	D mm	T mm	C mm	$r^{2)}$ min.	$r_1^{2)}$ min.	C_r	C_{0r}	C_u		d_a min.	D_a min.	S_a min.			r_a max.	$r_b^{2)}$ max.	e	Y_2	Y_3		Y_0				
237.330	9.3437	358.775	14.1250	152.400	6.0000	117.475	4.6250	6.4	1.6	1 660	3 170	333		M249736/M249710D	1	257	343	17.5	6.4	1.6	0.33	2.03	3.02	1.98	52.6
240	—	360	—	92	—	82	—	4	1.5	962	1 430	159		46248	1	258	338	5	3	1.5	0.32	2.12	3.15	2.07	29.6
		360		115		92		4	1.5	1 240	1 980	216		46248A	1	258	341	11.5	3	1.5	0.32	2.12	3.15	2.07	36.9
		360		170		142		4	1	1 630	3 090	321		46T483617	2	258	345	14	3	1	0.33	2.03	3.02	1.98	57.3
		400		128		114		5	1.5	1 490	2 180	241		46348	1	262	377	7	4	1.5	0.35	1.95	2.90	1.91	59.0
		400		160		128		5	1.5	1 940	3 060	325		46348A	1	262	373	16	4	1.5	0.35	1.95	2.90	1.91	76.2
		400		209		168		5	1.5	2 760	4 370	456		46T484021	1	262	378	20.5	4	1.5	0.33	2.03	3.02	1.98	98.5
		407		216		185		SP	SP	2 950	4 810	494		46T484122	1	258.8	385	15.5	4	SP	0.33	2.03	3.02	1.98	111
		440		274		224		5	1.5	4 210	6 850	665		46T484427	1	249	412	25	4	1.5	0.33	2.03	3.02	1.98	179
241.300	9.5000	327.025	12.8750	114.300	4.5000	82.550	3.2500	6.4	1.6	1 000	1 860	200		8578/8520D	1	261	310	15.9	6.4	1.6	0.41	1.66	2.47	1.62	24.1
	9.5000	349.148	13.7460	127.000	5.0000	101.600	4.0000	6.4	1.6	1 190	2 050	224		EE127095/127136D	1	261	330	12.7	6.4	1.6	0.35	1.91	2.84	1.86	36.4
	9.5000	355.498	13.9960	127.000	5.0000	101.600	4.0000	6.4	1.6	1 190	2 050	224		EE127095/127139D	1	261	330	12.7	6.4	1.6	0.35	1.91	2.84	1.86	39.1
	9.5000	368.300	14.5000	120.650	4.7500	85.725	3.3750	6.4	1.6	1 090	1 850	203		EE170950/171451D	1	261	336	17.5	6.4	1.6	0.36	1.86	2.77	1.82	41.7
	9.5000	393.700	15.5000	157.163	6.1875	109.538	4.3125	6.4	1.6	1 590	3 090	325		EE275095/275156D	1	261	378	23.8	6.4	1.6	0.40	1.68	2.50	1.64	73.3
	9.5000	406.400	16.0000	155.575	6.1250	107.950	4.2500	6.4	1.6	1 590	3 090	325		EE275095/275161D	1	261	378	23.8	6.4	1.6	0.40	1.68	2.50	1.64	79.3
	9.5000	406.400	16.0000	215.900	8.5000	184.150	7.2500	6.4	1.6	2 950	4 810	494		H249148/H249111D	1	261	385	15.9	6.4	1.6	0.33	2.03	3.02	1.98	110
	9.5000	444.500	17.5000	209.550	8.2500	158.750	6.2500	6.4	1.6	2 750	3 960	408		EE923095/923176D	1	261	407	25.4	6.4	1.6	0.34	2.01	2.99	1.96	128
	9.5000	488.950	19.2500	254.000	10.0000	196.850	7.7500	6.4	1.6	3 610	5 570	553		EE295950/295192D	1	261	446	28.6	6.4	1.6	0.31	2.18	3.24	2.13	209
244.475	9.6250	380.898	14.9960	171.450	6.7500	127.000	5.0000	6.4	1.6	1 690	2 930	306		EE126097/126149D	1	264	357	22.2	6.4	1.6	0.52	1.31	1.95	1.28	65.9
	9.6250	381.000	15.0000	171.450	6.7500	127.000	5.0000	6.4	1.6	1 690	2 930	306		EE126097/126151D	1	264	357	22.2	6.4	1.6	0.52	1.31	1.95	1.28	66.0
247.650	9.7500	368.300	14.5000	120.650	4.7500	85.725	3.3750	6.4	1.6	1 090	1 850	203		EE170975/171451D	1	267	336	17.5	6.4	1.6	0.36	1.86	2.77	1.82	39.4
	9.7500	406.400	16.0000	247.650	9.7500	203.200	8.0000	6.4	1.6	3 490	6 250	612		HH249949/HH249910D	1-P	267	383	22.2	6.4	1.6	0.33	2.03	3.02	1.98	123
249.250	9.8130	380.898	14.9960	171.450	6.7500	127.000	5.0000	6.4	1.6	1 690	2 930	306		EE126098/126149D	1	269	357	22.2	6.4	1.6	0.52	1.31	1.95	1.28	63.5
	9.8130	381.000	15.0000	171.450	6.7500	127.000	5.0000	6.4	1.6	1 690	2 930	306		EE126098/126151D	1	269	357	22.2	6.4	1.6	0.52	1.31	1.95	1.28	63.5
254.000	10.0000	347.663	13.6875	101.600	4.0000	69.850	2.7500	3.6	1.6	1 010	1 690	192		LM249748/LM249710D	1	268	332	15.9	3.6	1.6	0.33	2.03	3.02	1.98	24.1

[Notes] 1) While metric series bearings have minus tolerances for bore and OD, inch series have plus tolerances. Refer to page 194 for details of applicable tolerance standards.

2) SP indicates the specially chamfered form.

Double-row tapered roller bearings

TDO, TDOS type

d (254.000) ~ 260.350 mm

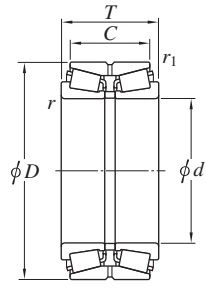

Design 1



Design 1-P



Design 2



Design 2-P

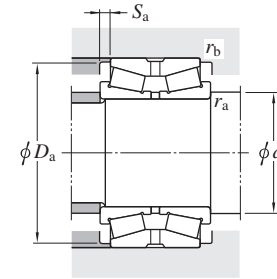

Boundary dimensions										Basic load ratings (kN)		Fatigue load limit (kN)	Bearing No. ¹⁾	Design	Mounting dimensions (mm)					Constant	Axial load factors			(Refer.) Mass (kg)
<i>d</i> mm	<i>D</i> mm	<i>T</i> mm	<i>C</i> mm	<i>r</i> min.	<i>r</i> ₁ min.	<i>C</i> _r	<i>C</i> _{0r}	<i>C</i> _u	<i>d</i> _a min.	<i>D</i> _a min.	<i>S</i> _a min.	<i>r</i> _a max.			<i>r</i> _b max.	<i>e</i>	<i>Y</i> ₂	<i>Y</i> ₃	<i>Y</i> ₀					
254.000	10.0000	358.775	14.1250	152.400	6.0000	117.475	4.6250	3.6	1.6	1 660	3 170	333	M249749/M249710D	1	268	343	17.5	3.6	1.6	0.33	2.03	3.02	1.98	45.0
	10.0000	365.125	14.3750	130.175	5.1250	98.425	3.8750	6.4	1.6	1 210	2 150	231	EE134100/134144D	1	273	346	15.9	6.4	1.6	0.37	1.80	2.69	1.76	39.8
	10.0000	393.700	15.5000	157.163	6.1875	109.538	4.3125	6.4	1.6	1 590	3 090	325	EE275100/275156D	1	273	378	23.8	6.4	1.6	0.40	1.68	2.50	1.64	67.3
	10.0000	406.400	16.0000	155.575	6.1250	107.950	4.2500	6.4	1.6	1 590	3 090	325	EE275100/275161D	1	273	378	23.8	6.4	1.6	0.40	1.68	2.50	1.64	73.4
	10.0000	422.275	16.6250	173.038	6.8125	128.588	5.0625	6.7	1.6	2 180	3 360	355	HM252343/HM252311D	1	274	398	22.2	6.7	1.6	0.33	2.03	3.02	1.98	87.0
	10.0000	422.275	16.6250	173.038	6.8125	128.588	5.0625	6.7	1.6	2 180	3 360	355	HM252344/HM252311D	1	274	398	22.2	6.7	1.6	0.33	2.03	3.02	1.98	87.0
	10.0000	422.275	16.6250	178.592	7.0312	139.700	5.5000	6.7	1.6	2 180	3 360	355	HM252343/HM252310D	1	274	400	19.4	6.7	1.6	0.33	2.03	3.02	1.98	89.8
	10.0000	422.275	16.6250	178.592	7.0312	139.700	5.5000	6.7	1.6	2 180	3 360	355	HM252344/HM252310D	1	274	400	19.4	6.7	1.6	0.33	2.03	3.02	1.98	89.8
	10.0000	431.724	16.9970	173.038	6.8125	128.588	5.0625	6.7	1.6	2 180	3 360	355	HM252343/HM252315D	1	274	398	22.2	6.7	1.6	0.33	2.03	3.02	1.98	93.3
	10.0000	431.724	16.9970	173.038	6.8125	128.588	5.0625	6.7	1.6	2 180	3 360	355	HM252344/HM252315D	1	274	398	22.2	6.7	1.6	0.33	2.03	3.02	1.98	93.3
	10.0000	533.400	21.0000	276.225	10.8750	165.100	6.5000	6.4	1.6	3 820	5 600	524	HH953749/HH953710D	1-P	273	496	55.6	6.4	1.6	0.94	0.72	1.07	0.70	267
	260	—	400	—	104	—	92	—	5	1.5	1 170	1 830	200	46252	1	282	373	6	4	1.5	0.33	2.03	3.02	1.98
—		400	—	130	—	104	—	5	1.5	1 520	2 480	265	46252A	1	282	376	13	4	1.5	0.32	2.12	3.15	2.07	54.8
—		400	—	146	—	108	—	6	1.5	1 630	2 570	274	46T524015	1	288	374	19	5	1.5	0.39	1.71	2.54	1.67	65.0
—		400	—	185	—	146	—	5	1.5	2 250	3 690	390	46T524019	1	282	378.4	19.5	4	1.5	0.29	2.32	3.45	2.26	77.1
—		440	—	144	—	128	—	5	1.5	1 900	2 880	302	46352	1	282	410	8	4	1.5	0.35	1.95	2.90	1.91	83.8
—		440	—	172	—	145	—	5	1.5	2 220	3 170	337	46T524417	1	282	414	13.5	4	1.5	0.43	1.59	2.36	1.55	97
—		440	—	180	—	144	—	5	1.5	2 430	3 960	408	46352A	1	282	409	18	4	1.5	0.35	1.95	2.90	1.91	105
—		440	—	224	—	180	—	5	1.5	3 380	5 350	547	46T524422	1	282	409	22	4	1.5	0.24	2.84	4.23	2.78	130
—		530	—	275	—	163.9	—	6	1.5	3 500	4 910	462	46T525328	1-P	288	506	55	5	1.5	1.18	0.57	0.85	0.56	255
260.350		10.2500	365.125	14.3750	130.175	5.1250	98.425	3.8750	6.4	1.6	1 210	2 150	231	EE134102/134144D	1	280	355	15.9	6.4	1.6	0.37	1.80	2.69	1.76
	10.2500	400.050	15.7500	155.575	6.1250	107.950	4.2500	9.5	1.6	1 630	2 570	274	EE221026/221576D	1	286	372	23.8	9.5	1.6	0.39	1.71	2.54	1.67	58.4
	10.2500	422.275	16.6250	173.038	6.8125	128.588	5.0625	6.7	1.6	2 180	3 360	355	HM252348/HM252311D	1	280	398	22.2	6.7	1.6	0.33	2.03	3.02	1.98	83.6
	10.2500	422.275	16.6250	178.592	7.0312	139.700	5.5000	6.7	1.6	2 180	3 360	355	HM252348/HM252310D	1	280	400	19.4	6.7	1.6	0.33	2.03	3.02	1.98	86.3
	10.2500	422.275	16.6250	178.592	7.0312	139.700	5.5000	6.7	1.6	2 180	3 360	355	HM252349/HM252310D	1	280	400	19.4	6.7	1.6	0.33	2.03	3.02	1.98	86.3
	10.2500	431.724	16.9970	173.038	6.8125	128.588	5.0625	6.7	1.6	2 180	3 360	355	HM252348/HM252315D	1	280	398	22.2	6.7	1.6	0.33	2.03	3.02	1.98	89.9
	10.2500	431.724	16.9970	173.038	6.8125	128.588	5.0625	6.7	1.6	2 180	3 360	355	HM252349/HM252315D	1	280	398	22.2	6.7	1.6	0.33	2.03	3.02	1.98	89.9
	10.2500	488.950	19.2500	254.000	10.0000	196.850	7.7500	6.4	1.6	3 610	5 570	553	EE295102/295192D	1	280	446	28.6	6.4	1.6	0.31	2.18	3.24	2.13	194

[Note] 1) While metric series bearings have minus tolerances for bore and OD, inch series have plus tolerances. Refer to page 194 for details of applicable tolerance standards.

Double-row tapered roller bearings

TDO, TDOS type

d 263.525 ~ 280.192 mm

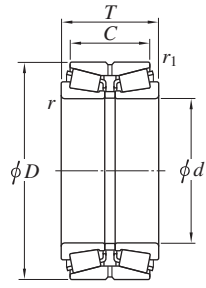

Design 1



Design 1-P



Design 2



Design 2-P

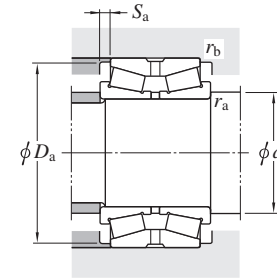

Boundary dimensions										Basic load ratings (kN)		Fatigue load limit (kN)	Bearing No. ¹⁾	Design	Mounting dimensions (mm)					Constant e	Axial load factors			(Refer.) Mass (kg)
d mm	D mm	T mm	C mm	$r^{2)}$ min.	$r_1^{2)}$ min.	C_r	C_{0r}	C_u		d_a min.	D_a min.	S_a min.			r_a max.	$r_b^{2)}$ max.	Y_2	Y_3	Y_0					
263.525	10.3750	355.600	14.0000	127.000	5.0000	101.600	4.0000	3.6	1.6	1 300	2 550	267	LM451345/LM451310D	1	277	343	12.7	3.6	1.6	0.36	1.87	2.79	1.83	33.1
266.700	10.5000	355.600	14.0000	127.000	5.0000	101.600	4.0000	3.6	1.6	1 300	2 550	267	LM451349/LM451310D	1	280	343	12.7	3.6	1.6	0.36	1.87	2.79	1.83	31.8
	10.5000	357.200	14.0630	127.000	5.0000	101.600	4.0000	3.6	1.6	1 300	2 550	267	LM451349/LM451312D	1	280	343	12.7	3.6	1.6	0.36	1.87	2.79	1.83	32.5
	10.5000	393.700	15.5000	157.163	6.1875	109.538	4.3125	6.4	1.6	1 590	3 090	325	EE275105/275156D	1	286	378	23.8	6.4	1.5	0.40	1.68	2.50	1.64	60.9
	10.5000	406.400	16.0000	155.575	6.1250	107.950	4.2500	6.4	1.6	1 590	3 090	325	EE275105/275161D	1	286	378	23.8	6.4	1.6	0.40	1.68	2.50	1.64	67.1
	10.5000	422.275	16.6250	178.598	7.0314	139.700	5.5000	6.7	1.6	2 110	3 420	352	EE551050/551663D	1	287	390	19.4	6.7	1.6	0.33	2.03	3.02	1.98	82.6
	10.5000	431.724	16.9970	173.038	6.8125	128.588	5.0625	6.7	1.6	2 110	3 420	352	EE551050/551701D	1	287	389	22.2	6.7	1.6	0.33	2.03	3.02	1.98	85.9
269.875	10.6250	381.000	15.0000	158.750	6.2500	123.825	4.8750	6.4	1.6	1 840	3 350	349	M252349/M252310D	1	289	364	17.5	6.4	1.6	0.33	2.03	3.02	1.98	51.4
273.050	10.7500	393.700	15.5000	157.163	6.1875	109.538	4.3125	6.4	1.6	1 590	3 090	325	EE275108/275156D	1	292	378	23.8	6.4	1.6	0.40	1.68	2.50	1.64	57.6
	10.7500	406.400	16.0000	155.575	6.1250	107.950	4.2500	6.4	1.6	1 590	3 090	325	EE275108/275161D	1	292	378	23.8	6.4	1.6	0.40	1.68	2.50	1.64	63.8
279.400	11.0000	469.900	18.5000	200.025	7.8750	149.225	5.8750	9.5	1.6	2 650	4 370	437	EE722110/722186D	1	305	431	25.4	9.5	1.6	0.38	1.79	2.67	1.75	127
	11.0000	488.950	19.2500	254.000	10.0000	196.850	7.7500	1.2	1.6	3 610	5 570	553	EE295110/295192D	1	288	446	28.6	1.2	1.6	0.31	2.18	3.24	2.13	178
279.982	11.0229	380.898	14.9960	139.700	5.5000	107.950	4.2500	3.6	1.6	1 420	2 820	286	LM654642/LM654610D	1	294	371	15.9	3.6	1.6	0.43	1.57	2.34	1.53	42.7
280	—	400	—	150	—	120	—	SP	SP	1 650	2 950	307	46T564015	1	302	386	15	4	SP	0.39	1.75	2.61	1.71	66.0
280.000	11.0236	406.400	16.0000	149.225	5.8750	117.475	4.6250	6.4	1.6	1 650	2 950	307	EE128112/128160D	1	299	383	15.9	6.4	1.6	0.39	1.75	2.61	1.71	58.8
	11.0236	406.400	16.0000	149.225	5.8750	117.475	4.6250	6.4	1.6	1 650	2 950	307	EE128114/128160D	1	299	383	15.9	6.4	1.6	0.39	1.75	2.61	1.71	58.8
280	—	420	—	106	—	94	—	5	1.5	1 260	1 970	213	46256	1	302	395	6	4	1.5	0.33	2.03	3.02	1.98	46.9
	—	420	—	133	—	106	—	5	1.5	1 570	2 610	277	46256A	1	302	394	13.5	4	1.5	0.33	2.03	3.02	1.98	58.9
	—	460	—	146	—	130	—	6	2	1 950	2 930	308	46356	1	308	430	8	5	2	0.35	1.95	2.90	1.91	90.0
	—	460	—	183	—	146	—	6	2	2 470	3 940	407	46356A	1	308	434	18.5	5	2	0.35	1.95	2.90	1.91	111
	—	500	—	195	—	145	—	6	1.5	3 140	4 520	465	46T565020-1	1-P	308	461	25	5	1.5	0.40	1.68	2.50	1.64	150
280.192	11.0312	406.400	16.0000	120.650	4.7500	85.725	3.3750	6.7	1.6	1 120	1 980	209	EE101103/101601D	1	300	375	17.5	6.7	1.6	0.41	1.66	2.47	1.62	45.5
	11.0312	406.400	16.0000	149.225	5.8750	117.475	4.6250	6.7	1.6	1 650	2 950	307	EE128111/128160D	1	300	383	15.9	6.7	1.6	0.39	1.75	2.61	1.71	58.6

[Notes] 1) While metric series bearings have minus tolerances for bore and OD, inch series have plus tolerances. Refer to page 194 for details of applicable tolerance standards.

2) SP indicates the specially chamfered form.

Double-row tapered roller bearings

TDO, TDOS type

d 285.750 ~ 304.800 mm

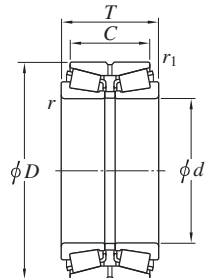

Design 1



Design 1-P



Design 2

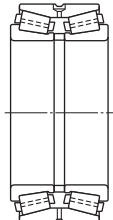

Design 2-P

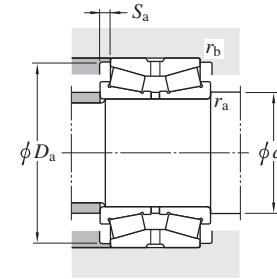

Boundary dimensions										Basic load ratings (kN)		Fatigue load limit (kN)	Bearing No. ¹⁾	Design	Mounting dimensions (mm)					Constant e	Axial load factors			(Refer.) Mass (kg)
d mm	D mm	T mm	C mm	$r^{2)}$ min.	r_1 min.	C_r	C_{0r}	C_u		d_a min.	D_a min.	S_a min.			r_a max.	r_b max.	Y_2	Y_3	Y_0					
285.750	11.2500	358.775	14.1250	76.200	3.0000	53.975	2.1250	3.6	1.6	516	1 070	122	545112/545142D LM654649/LM654610D EE147112/147198D	1	299	345	11.1	3.6	1.6	0.49	1.38	2.06	1.35	15.5
	11.2500	380.898	14.9960	139.700	5.5000	107.950	4.2500	3.6	1.6	1 420	2 820	286		1	299	371	15.9	3.6	1.6	0.43	1.57	2.34	1.53	39.9
	11.2500	501.650	19.7500	203.200	8.0000	120.650	4.7500	6.4	3.2	2 440	3 460	345		1	305	467	41.3	6.4	3.2	0.83	0.81	1.20	0.79	142
288.925	11.3750	406.400	16.0000	165.100	6.5000	130.175	5.1250	6.4	1.6	2 160	4 420	445	M255449/M255410D	1	308	388	17.5	6.4	1.6	0.34	2.00	2.97	1.95	64.7
290	—	400	—	120	—	90	—	5	1.5	1 490	2 600	274	46T584012 46T584117	1	312	385	15	4	1.5	0.42	1.61	2.40	1.58	40.1
	—	405	—	165	—	130	—	SP	1	1 860	3 750	375		2	309	388	17.5	4	1	0.34	2.00	2.97	1.95	61.2
292.100	11.5000	374.650	14.7500	104.775	4.1250	79.375	3.1250	3.6	1.6	1 010	1 940	222	L555249/L555210D EE722115/722186D EE790114/790223D	1	306	361	12.7	3.6	1.6	0.40	1.68	2.50	1.64	25.6
	11.5000	469.900	18.5000	200.025	7.8750	149.225	5.8750	9.5	1.6	2 650	4 370	437		1	318	431	25.4	9.5	1.6	0.38	1.79	2.67	1.75	118
	11.5000	558.800	22.0000	298.450	11.7500	222.250	8.7500	6.4	1.6	5 060	8 000	746		1-P	311	515	38.1	6.4	1.6	0.40	1.71	2.54	1.67	307
298.450	11.7500	444.500	17.5000	146.050	5.7500	98.425	3.8750	7.9	1.6	1 550	2 760	288	EE291175/291751D	1	321	414	23.8	7.9	1.6	0.38	1.79	2.66	1.75	69.3
300	—	440	—	139	—	100	—	4	0.6	1 710	2 870	300	46T604414 46260 46260A 46360 46360A 46360D	1	318	412	19.5	3	0.6	0.37	1.80	2.69	1.76	63.8
	—	460	—	118	—	105	—	5	1.5	1 630	2 400	254		1	322	436	6.5	4	1.5	0.32	2.12	3.15	2.07	64.6
	—	460	—	148	—	118	—	5	1.5	2 050	3 230	331		1	322	433	15	4	1.5	0.32	2.12	3.15	2.07	80.2
	—	500	—	160	—	142	—	6	2	2 320	3 540	366		1	328	469	9	5	2	0.35	1.95	2.90	1.91	116
	—	500	—	200	—	160	—	6	2	2 860	4 630	463		1	328	466	20	5	2	0.35	1.95	2.90	1.91	144
	—	500	—	200	—	160	—	6	1.5	3 140	4 650	474		1	328	475	20	5	1.5	0.40	1.68	2.50	1.64	139
300.038	11.8125	422.275	16.6250	174.625	6.8750	136.525	5.3750	6.4	1.6	2 130	4 030	409	HM256849/HM256810D	1	320	403	19.1	6.4	1.6	0.34	2.00	2.98	1.96	70.1
304.800	12.0000	393.700	15.5000	107.950	4.2500	82.550	3.2500	6.4	1.6	1 130	2 360	266	L357049/L357010D EE109120/109163D EE291201/291751D EE941205/941951D EE941205/941953D EE724119/724196D EE724120/724196D EE790120/790223D	1	325	379	12.7	6.4	1.6	0.36	1.88	2.80	1.84	30.7
	12.0000	412.750	16.2500	123.825	4.8750	92.075	3.6250	6.4	1.6	1 280	2 410	250		1	325	394	15.9	6.4	1.6	0.43	1.58	2.35	1.55	42.1
	12.0000	444.500	17.5000	146.050	5.7500	98.425	3.8750	7.9	1.6	1 550	2 760	288		1	328	414	23.8	7.9	1.6	0.38	1.79	2.66	1.75	65.9
	12.0000	495.300	19.5000	162.245	6.3876	120.650	4.7500	6.4	1.6	2 360	3 840	393		1	315	463	20.8	6.4	1.6	0.40	1.68	2.50	1.64	112
	12.0000	495.300	19.5000	168.595	6.6376	127.000	5.0000	6.4	1.6	2 360	3 840	393		1	315	463	20.8	6.4	1.6	0.40	1.68	2.50	1.64	117
	12.0000	495.300	19.5000	196.850	7.7500	146.050	5.7500	16	1.6	2 740	4 680	461		1	344	458	25.4	16	1.6	0.40	1.68	2.50	1.64	135
	12.0000	495.300	19.5000	196.850	7.7500	146.050	5.7500	16	1.6	2 740	4 680	461		1	344	458	25.4	16	1.6	0.40	1.68	2.50	1.64	135
	12.0000	558.800	22.0000	298.450	11.7500	222.250	8.7500	1.2	1.6	5 060	8 000	746		1-P	315	515	38.1	1.2	1.6	0.40	1.71	2.54	1.67	293

[Notes] 1) While metric series bearings have minus tolerances for bore and OD, inch series have plus tolerances. Refer to page 194 for details of applicable tolerance standards.

2) SP indicates the specially chamfered form.

Double-row tapered roller bearings

TDO, TDOS type

d 310 ~ (340) mm

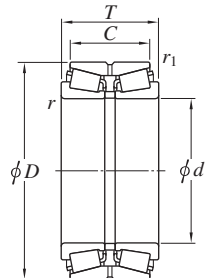

Design 1



Design 1-P



Design 2



Design 2-P

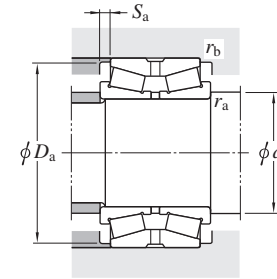

Boundary dimensions										Basic load ratings (kN)		Fatigue load limit (kN)	Bearing No. ¹⁾	Design	Mounting dimensions (mm)					Constant <i>e</i>	Axial load factors			(Refer.) Mass (kg)
<i>d</i> mm	<i>D</i> mm	<i>T</i> mm	<i>C</i> mm	<i>r</i> ²⁾ min.	<i>r</i> ₁ min.	<i>C</i> _r	<i>C</i> _{0r}	<i>C</i> _u	<i>d</i> _a min.	<i>D</i> _a min.	<i>S</i> _a min.	<i>r</i> _a max.			<i>r</i> _b max.	<i>e</i>	<i>Y</i> ₂	<i>Y</i> ₃	<i>Y</i> ₀					
310	—	470	—	200	—	149	—	SP	1.5	2 740	4 810	481	46T624720	1	336	445	25.5	5	1.5	0.38	1.76	2.62	1.72	113
311.150	12.2500	558.800	22.0000	190.500	7.5000	111.125	4.3750	9.5	3.2	2 360	3 490	346	EE148122/148221D	1	338	505	39.7	9.5	3.2	0.88	0.77	1.15	0.75	171
317.500	12.5000	444.500	17.5000	146.050	5.7500	98.425	3.8750	7.9	1.6	1 550	2 760	288	EE291250/291751D	1	341	414	23.8	7.9	1.6	0.38	1.79	2.66	1.75	58.9
	12.5000	447.675	17.6250	180.975	7.1250	146.050	5.7500	3.6	1.6	2 400	4 770	465	HM259049./HM259010D.	1	328	428	17.5	3.6	1.6	0.33	2.02	3.00	1.97	83.0
317.5	—	558.8	—	254	—	174	—	6	1.5	3 900	6 050	568	46T645625A	1-P	345.5	538	40	5	1.5	0.81	0.83	1.23	0.81	231
317.500	12.5000	622.300	24.5000	304.800	12.0000	174.625	6.8750	14.3	3.2	4 780	6 990	632	H961649/H961610D	1-P	354	585	65.1	14.3	3.2	0.94	0.72	1.07	0.70	378
320	—	480	—	121	—	108	—	5	1.5	1 800	2 700	283	46264	1	342	452	6.5	4	1.5	0.32	2.12	3.15	2.07	71.6
	—	480	—	151	—	121	—	5	1.5	2 060	3 410	342	46264A	1	342	454	15	4	1.5	0.32	2.12	3.15	2.07	87.7
	—	480	—	215	—	163	—	5	1.5	3 250	5 610	547	46T644822AC	2	342	460	26	4	1.5	0.46	1.47	2.19	1.44	123
	—	540	—	176	—	157	—	6	2	2 880	4 570	457	46364	1	348	502	9.5	5	2	0.35	1.95	2.90	1.91	154
	—	540	—	220	—	176	—	6	2	3 280	5 390	528	46364A	1	348	497	22	5	2	0.35	1.95	2.90	1.91	190
	—	550	—	240	—	180	—	5	2.5	4 140	6 420	630	46T645524AC	2	342	514	30	4	2	0.40	1.68	2.50	1.64	221
329.870	12.9870	533.400	21.0000	165.100	6.5000	114.300	4.5000	4.8	1.6	2 350	3 580	362	EE971298/972102D	1	346.5	494	25.4	4.8	1.6	0.33	2.03	3.02	1.98	124
	12.9870	546.100	21.5000	177.800	7.0000	152.400	6.0000	4.8	3.2	2 350	3 580	362	EE971298/972151D	1	347	500	12.7	4.8	3.2	0.33	2.03	3.02	1.98	150
330	—	500	—	190	—	150	—	6	1.5	2 800	4 720	467	46T665019	1	358	473	20	5	1.5	0.39	1.74	2.59	1.70	120
330.200	13.0000	482.600	19.0000	133.350	5.2500	88.900	3.5000	7.1	1.6	1 320	2 500	247	EE161300/161901D	1	352	454	22.2	7.1	1.6	0.50	1.35	2.01	1.32	74.8
	13.0000	482.600	19.0000	177.800	7.0000	127.000	5.0000	6.4	1.6	2 320	4 100	404	EE526130/526191D	1	350	454	25.4	6.4	1.6	0.39	1.73	2.57	1.69	96.4
	13.0000	482.600	19.0000	177.800	7.0000	127.000	5.0000	3.2	1.6	2 320	4 100	404	EE526132/526191D	1	344	454	25.4	3.2	1.6	0.39	1.73	2.57	1.69	96.5
330.25	—	528	—	292	—	210	—	5	1.5	4 620	8 280	758	46T665329	1	353	507	41	4	1.5	0.43	1.57	2.34	1.53	223
333.375	13.1250	469.900	18.5000	190.500	7.5000	152.400	6.0000	6.4	1.6	2 900	5 680	548	HM261049/HM261010D	1-P	354	449	19.1	6.4	1.6	0.33	2.02	3.00	1.97	97.6
340	—	500	—	150	—	120	—	6	2	2 230	3 630	367	46T685015	1-P	368	476	15	5	2	0.42	1.62	2.42	1.59	91.4
	—	500	—	249.225	—	203.2	—	5	1	3 340	6 450	610	46T6850	1	362	477	23	4	1	0.33	2.03	3.02	1.98	155
	—	520	—	133	—	118	—	6	2	1 940	3 070	314	46268	1	368	489	7.5	5	2	0.32	2.12	3.15	2.07	95.3

[Notes] 1) While metric series bearings have minus tolerances for bore and OD, inch series have plus tolerances. Refer to page 194 for details of applicable tolerance standards.

2) SP indicates the specially chamfered form.

Double-row tapered roller bearings

TDO, TDOS type

d (340) ~ 368.249 mm

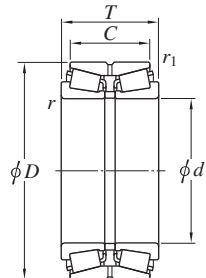

Design 1



Design 1-P

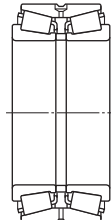

Design 2



Design 2-P

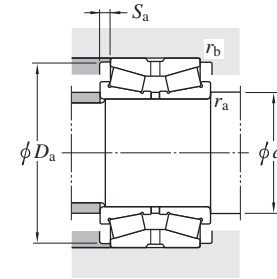

Boundary dimensions										Basic load ratings (kN)		Fatigue load limit (kN)	Bearing No. ¹⁾	Design	Mounting dimensions (mm)					Constant <i>e</i>	Axial load factors			(Refer.) Mass (kg)
<i>d</i> mm	<i>D</i> mm	<i>T</i> mm	<i>C</i> mm	<i>r</i> min.	<i>r</i> ₁ min.	<i>C</i> _r	<i>C</i> _{0r}	<i>C</i> _u	<i>d</i> _a min.	<i>D</i> _a min.	<i>S</i> _a min.	<i>r</i> _a max.			<i>r</i> _b max.	<i>e</i>	<i>Y</i> ₂	<i>Y</i> ₃	<i>Y</i> ₀					
340	—	520	—	165	—	133	—	6	2	2 420	4 060	406	46268A 46368 46368A 46T685824 46T685831C	1	368	491	16	5	2	0.32	2.12	3.15	2.07	117
	—	580	—	190	—	169	—	6	2	2 980	4 620	454		1	368	539	10.5	5	2	0.35	1.95	2.90	1.91	198
	—	580	—	238	—	190	—	6	2	3 820	6 340	606		1	368	543	24	5	2	0.35	1.95	2.90	1.91	244
	—	580	—	241	—	170	—	6	1.5	4 370	6 890	660		1	368	540	35.5	5	1.5	0.43	1.57	2.34	1.53	237
	—	580	—	305	—	241	—	6	1.5	5 530	10 100	874		2-P	368	544	32	5	1.5	0.46	1.47	2.19	1.44	319
342.900	13.5000	533.400	21.0000	165.100	6.5000	114.300	4.5000	4.8	1.6	2 350	3 580	362	EE971354/972102D EE971354/972151D	1	360	494	25.4	4.8	1.6	0.33	2.03	3.02	1.98	115
	13.5000	546.100	21.5000	177.800	7.0000	152.400	6.0000	4.8	3.2	2 350	3 580	362		1	360	500	12.7	4.8	3.2	0.33	2.03	3.02	1.98	141
346.075	13.6250	482.600	19.0000	133.350	5.2500	88.900	3.5000	7.1	1.6	1 320	2 500	247	EE161363/161901D HM262749/HM262710D	1	368	454	22.2	7.1	1.6	0.50	1.35	2.01	1.32	66.1
	13.6250	488.950	19.2500	200.025	7.8750	158.750	6.2500	6.4	1.6	2 890	5 800	553		1	366	467	20.6	6.4	1.6	0.33	2.02	3.00	1.97	111
349.250	13.7500	514.350	20.2500	193.675	7.6250	152.400	6.0000	6.4	1.6	2 740	5 070	499	EE333137/333203D	1	370	483	20.6	6.4	1.6	0.37	1.80	2.69	1.76	126
355	—	515	—	194	—	152.4	—	6.4	1.5	2 740	5 110	499	46T715219C	2	383	478	20.8	5	1.5	0.37	1.84	2.74	1.80	121
355.600	14.0000	444.500	17.5000	136.525	5.3750	111.125	4.3750	3.6	1.6	1 390	3 450	332	L163149/L163110D EE161400/161901D EE231400/231976D EE231400/232026D EE333140/333203D	1	370	428	12.7	3.6	1.6	0.31	2.20	3.27	2.15	45.0
	14.0000	482.600	19.0000	133.350	5.2500	88.900	3.5000	7.1	1.6	1 320	2 500	247		1	377	454	22.2	7.1	1.6	0.50	1.35	2.01	1.32	60.7
	14.0000	501.650	19.7500	155.575	6.1250	107.950	4.2500	6.4	1.6	1 700	3 280	322		1	376	481	23.8	6.4	1.6	0.44	1.53	2.28	1.50	87.2
	14.0000	514.350	20.2500	155.575	6.1250	107.950	4.2500	6.4	1.6	1 700	3 280	322		1	376	481	23.8	6.4	1.6	0.44	1.53	2.28	1.50	95.7
	14.0000	514.350	20.2500	193.675	7.6250	152.400	6.0000	6.4	1.6	2 740	5 070	499		1	376	483	20.6	6.4	1.6	0.37	1.80	2.69	1.76	120
360	—	540	—	134	—	120	—	6	2	2 070	3 290	332	46272 46272A 46T725418 46T725932 46372 46372A	1	388	510	7	5	2	0.32	2.12	3.15	2.07	93.0
	—	540	—	169	—	134	—	6	2	2 530	4 230	419		1	388	512	17.5	5	2	0.32	2.12	3.15	2.07	124
	—	540	—	184	—	140	—	6	1.5	3 020	4 980	487		1	388	510	22	5	1.5	0.29	2.32	3.45	2.26	131
	—	590	—	320	—	260	—	6	1.5	6 190	11 500	1 010		1	388	556	30	5	1.5	0.35	1.95	2.90	1.91	328
	—	600	—	192	—	171	—	6	2	3 140	4 880	473		1	388	557	10.5	5	2	0.35	1.95	2.90	1.91	206
	—	600	—	240	—	192	—	6	2	4 590	7 230	689		1-P	388	568	24	5	2	0.39	1.74	2.59	1.70	254
368.249	14.4980	523.875	20.6250	214.313	8.4375	169.863	6.6875	6.4	1.6	3 590	7 060	663	46T745221 HM265049/HM265010D	1	388	505	22.2	6.4	1.6	0.33	2.03	3.02	1.98	138
	14.4980	523.875	20.6250	214.313	8.4375	169.863	6.6875	6.4	1.6	3 420	6 780	644		1-P	388	505	22.2	6.4	1.6	0.33	2.03	3.02	1.98	119

[Note] 1) While metric series bearings have minus tolerances for bore and OD, inch series have plus tolerances. Refer to page 194 for details of applicable tolerance standards.

Double-row tapered roller bearings

TDO, TDOS type

d 368.300 ~ (400) mm

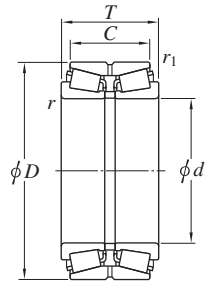

Design 1



Design 1-P



Design 2



Design 2-P

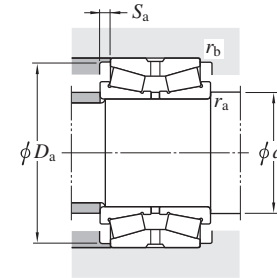

Boundary dimensions								Basic load ratings (kN)		Fatigue load limit (kN)	Bearing No. ¹⁾	Design	Mounting dimensions (mm)					Constant e	Axial load factors			(Refer.) Mass (kg)		
d mm	D mm	T mm	C mm	$r^{2)}$ min.	r_1 min.	C_r	C_{0r}	C_u	d_a min.	D_a min.			S_a min.	r_a max.	r_b max.	Y_2	Y_3		Y_0					
368.300	14.5000	596.900	23.5000	203.200	8.0000	133.350	5.2500	9.5	2.4	3 410	5 410	526	EE181453/182351D	1-P	395	555	34.9	9.5	2.4	0.41	1.63	2.42	1.59	203
370	—	680	—	280	—	188	—	6	2.5	4 890	8 610	749	46T746828AC	2-P	398	630	46	5	2	0.87	0.78	1.16	0.76	422
371.475	14.6250	501.650	19.7500	155.575	6.1250	107.950	4.2500	6.4	1.6	1 700	3 280	322	EE231462/231976D	1	392	481	23.8	6.4	1.6	0.44	1.53	2.28	1.50	76.2
	14.6250	514.350	20.2500	155.575	6.1250	107.950	4.2500	6.4	1.6	1 700	3 280	322	EE231462/232026D	1	392	481	23.8	6.4	1.6	0.44	1.53	2.28	1.50	84.7
380	—	520	—	149	—	112	—	5	1.5	2 180	3 990	391	46T765215	1	402	493	18.5	4	1.5	0.29	2.32	3.45	2.26	82
	—	560	—	135	—	122	—	6	2	2 190	3 560	355	46276	1	408	530	6.5	5	2	0.32	2.12	3.15	2.07	100
	—	560	—	171	—	135	—	6	2	2 810	4 670	456	46276A	1	408	531	18	5	2	0.39	1.74	2.59	1.70	129
	—	620	—	194	—	173	—	6	2	3 380	5 220	500	46376	1	408	582	10.5	5	2	0.39	1.74	2.59	1.70	215
	—	620	—	241	—	170	—	6	1.5	4 330	7 080	669	46T766224	1	408	575	35.5	5	1.5	0.46	1.47	2.19	1.44	255
	—	620	—	243	—	194	—	6	2	4 390	7 360	683	46376A	1	408	587	24.5	5	2	0.35	1.95	2.90	1.91	265
381.000	15.0000	508.000	20.0000	139.700	5.5000	88.900	3.5000	6.4	1.6	1 480	2 980	288	EE192150/192201D	1	401	480	25.4	6.4	1.6	0.53	1.27	1.89	1.24	66.7
	15.0000	546.100	21.5000	222.250	8.7500	177.800	7.0000	6.4	1.6	4 090	8 430	773	HM266447/HM266410D	1-P	401	520	22.2	6.4	1.6	0.33	2.03	3.02	1.98	166
	15.0000	590.550	23.2500	244.475	9.6250	193.675	7.6250	6.4	1.6	4 240	8 930	803	M268730/M268710D	1-P	401	565	25.4	6.4	1.6	0.33	2.03	3.02	1.98	244
384.175	15.1250	546.100	21.5000	222.250	8.7500	177.800	7.0000	6.4	1.6	4 090	8 430	773	HM266449/HM266410D	1-P	404	520	22.2	6.4	1.6	0.33	2.03	3.02	1.98	163
385	—	550	—	220	—	180	—	SP	1.5	4 090	8 430	773	46T775522	1-P	408	524	20	4	1.5	0.33	2.03	3.02	1.98	170
390	—	630	—	254	—	170	—	6	1.5	4 340	7 490	672	46T786325	1-P	418	601	42	5	1.5	0.76	0.88	1.31	0.86	290
393.700	15.5000	539.750	21.2500	142.875	5.6250	101.600	4.0000	6.4	1.6	1 860	3 810	357	EE234154/234213D	1	414	515	20.6	6.4	1.6	0.48	1.42	2.11	1.39	89.0
	15.5000	546.100	21.5000	158.750	6.2500	117.475	4.6250	6.4	1.6	1 860	3 810	357	EE234154/234216D	1	414	515	20.6	6.4	1.6	0.48	1.42	2.11	1.39	102
396.875	15.6250	539.750	21.2500	142.875	5.6250	101.600	4.0000	6.4	1.6	1 860	3 810	357	EE234156/234213D	1	417	515	20.6	6.4	1.6	0.48	1.42	2.11	1.39	86.8
	15.6250	546.100	21.5000	158.750	6.2500	117.475	4.6250	6.4	1.6	1 860	3 810	357	EE234156/234216D	1	417	515	20.6	6.4	1.6	0.48	1.42	2.11	1.39	100
400	—	540	—	140	—	100	—	6	1.5	1 860	3 840	369	46T805414	1	428	510	20	5	1.5	0.48	1.42	2.11	1.39	81.8
	—	600	—	148	—	132	—	6	2	2 350	3 720	366	46280	1	428	560	8	5	2	0.32	2.12	3.15	2.07	135
	—	600	—	185	—	148	—	6	2	3 030	5 150	491	46280A	1	428	563	18.5	5	2	0.32	2.12	3.15	2.07	167

[Notes] 1) While metric series bearings have minus tolerances for bore and OD, inch series have plus tolerances. Refer to page 194 for details of applicable tolerance standards.

2) SP indicates the specially chamfered form.

Double-row tapered roller bearings

TDO, TDOS type

d (400) ~ (431.800) mm

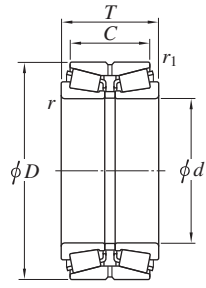

Design 1



Design 1-P



Design 2



Design 2-P

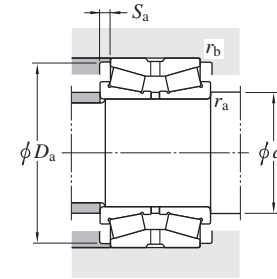

Boundary dimensions										Basic load ratings (kN)		Fatigue load limit (kN)	Bearing No. ¹⁾	Design	Mounting dimensions (mm)					Constant e	Axial load factors			(Refer.) Mass (kg)
d mm	D mm	T mm	C mm	$r^{2)}$ min.	$r_1^{2)}$ min.	C_r	C_{0r}	C_u	d_a min.	D_a min.	S_a min.	r_a max.			r_b max.	Y_2	Y_3	Y_0						
400	—	600	—	205	—	150	—	6	1.5	3 550	6 270	593	46T806021	1	428	560	27.5	5	1.5	0.40	1.68	2.50	1.64	187
	—	650	—	200	—	178	—	6	3	3 740	5 920	565	46380	1	428	605	11	5	2.5	0.35	1.95	2.90	1.91	243
	—	650	—	250	—	200	—	6	3	5 110	8 850	811	46380A	1-P	428	610	25	5	2.5	0.35	1.95	2.90	1.91	306
	—	650	—	280	—	180	—	6	2.5	4 890	8 610	749	46T806528AC	2-P	428	625	50	5	2	0.87	0.78	1.16	0.76	335
406.400	16.0000	539.750	21.2500	142.875	5.6250	101.600	4.0000	6.4	1.6	1 860	3 810	357	EE234160/234213D	1	428	515	20.6	6.4	1.6	0.48	1.42	2.11	1.39	80.2
	16.0000	546.100	21.5000	158.750	6.2500	117.475	4.6250	6.4	1.6	1 860	3 810	357	EE234160/234216D	1	428	515	20.6	6.4	1.6	0.48	1.42	2.11	1.39	92.6
	16.0000	574.675	22.6250	157.163	6.1875	106.363	4.1875	6.7	1.6	2 040	3 880	367	EE285160/285228D	1	428	535	25.4	6.7	1.6	0.50	1.35	2.01	1.32	113
	16.0000	574.675	22.6250	175.000	6.8898	118.000	4.6457	SP	SP	2 530	4 620	439	46T815718	1-P	426.4	550	28.5	4	2	0.70	0.97	1.44	0.94	126
	16.0000	590.550	23.2500	228.600	9.0000	174.625	6.8750	9.5	1.6	3 830	7 070	658	EE833160X/833233D	1	434	560	27	9.5	1.6	0.32	2.08	3.10	2.04	188
	16.0000	609.524	23.9970	177.800	7.0000	133.350	5.2500	7.9	1.6	3 260	6 060	567	EE736160/736239D	1	431	575	22.2	4	7.9	0.35	1.95	2.90	1.91	164
	16.0000	609.600	24.0000	187.325	7.3750	123.825	4.8750	6.7	1.6	3 060	5 280	503	EE911600/912401D	1	428	570	31.8	6.7	1.6	0.38	1.76	2.62	1.72	167
	16.0000	673.100	26.5000	192.639	7.5842	127.000	5.0000	6.4	1.6	3 170	5 240	494	EE571602/572651D	1	428	620	32.8	6.4	1.6	0.40	1.68	2.50	1.64	232
	16.0000	673.100	26.5000	192.639	7.5842	152.400	6.0000	6.4	1.6	3 170	5 240	494	EE571602/572653D	1	428	630	20.1	6.4	1.6	0.40	1.68	2.50	1.64	242
	409.575	16.1250	546.100	21.5000	185.738	7.3125	147.638	5.8125	6.4	1.6	2 850	5 740	541	M667948/M667911D	1	431	530	19.1	6.4	1.6	0.42	1.62	2.42	1.59
415.925	16.3750	590.550	23.2500	244.475	9.6250	193.675	7.6250	6.4	1.6	4 240	8 930	803	M268749/M268710D	1-P	437	565	25.4	6.4	1.6	0.33	2.03	3.02	1.98	203
420	—	620	—	150	—	134	—	6	2	2 520	4 130	399	46284	1	448	590	8	5	2	0.33	2.03	3.02	1.98	142
	—	620	—	188	—	150	—	6	2	3 390	5 660	534	46284A	1	448	589	19	5	2	0.39	1.74	2.59	1.70	176
	—	620	—	190	—	125	—	6	1.5	2 580	4 380	415	46T846219	1	448	583	32	5	1.5	0.35	1.95	2.91	1.91	184
	—	622.3	—	240	—	135	—	7.5	1.5	3 380	5 920	542	46T846224	1	456	605	52.5	6	1.5	0.87	0.78	1.16	0.76	214
	—	700	—	224	—	200	—	6	3	4 650	6 880	647	46384	1	448	656	12	5	2.5	0.39	1.74	2.59	1.70	325
	—	700	—	274	—	200	—	6	2.5	6 050	9 570	873	46T847027	1-P	448	650	37	5	2	0.32	2.12	3.15	2.07	386
	—	700	—	280	—	224	—	6	3	6 040	9 620	861	46384A	1-P	448	659	28	5	2.5	0.39	1.74	2.59	1.70	400
	430.213	16.9375	603.250	23.7500	159.639	6.2850	104.775	4.1250	6.4	1.6	2 090	3 770	361	EE241693/242377D	1	451	565	27.4	6.4	1.6	0.53	1.28	1.91	1.26
431.800	17.0000	571.500	22.5000	155.575	6.1250	111.125	4.3750	3.2	1.6	2 110	4 270	405	LM869448/LM869410D	1	447	555	22.2	3.2	1.6	0.55	1.24	1.84	1.21	97.3
	17.0000	603.250	23.7500	159.639	6.2850	104.775	4.1250	6.4	1.6	2 090	3 770	361	EE241701/242377D	1	453	565	27.4	6.4	1.6	0.53	1.28	1.91	1.26	112

[Notes] 1) While metric series bearings have minus tolerances for bore and OD, inch series have plus tolerances. Refer to page 194 for details of applicable tolerance standards.

2) SP indicates the specially chamfered form.

Double-row tapered roller bearings

TDO, TDOS type

d (431.800) ~ 482.600 mm

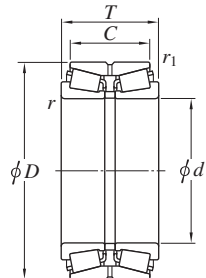

Design 1



Design 1-P



Design 2



Design 2-P

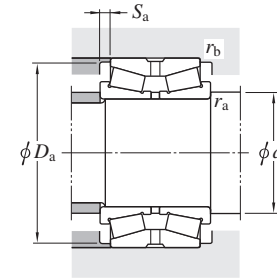

Boundary dimensions								Basic load ratings (kN)		Fatigue load limit (kN)	Bearing No. ¹⁾	Design	Mounting dimensions (mm)					Constant e	Axial load factors			(Refer.) Mass (kg)							
d mm	D mm	T mm	C mm	$r^{(2)}$ min.	$r_1^{(2)}$ min.	C_r	C_{0r}	C_u	d_a min.	D_a min.			S_a min.	r_a max.	r_b max.	Y_2	Y_3		Y_0										
431.800	17.0000	673.100	26.5000	192.639	7.5842	127.000	5.0000	6.4	1.6	3 170	5 240	494	EE571703/572651D EE571703/572653D	1	453	620	32.8	6.4	1.6	0.40	1.68	2.50	1.64	207					
	17.0000	673.100	26.5000	192.639	7.5842	152.400	6.0000	6.4	1.6	3 170	5 240	494			453	630	20.1	6.4	1.6						0.40	1.68	2.50	1.64	217
440	—	650	—	157	—	140	—	6	3	2 840	4 430	423	46288 46288A 46388A	1 1 1-P	468	622	8.5	5	2.5	0.33	2.03	3.02	1.98	156					
	—	650	—	196	—	157	—	6	3	3 770	6 370	600			468	620	19.5	5	2.5						0.39	1.74	2.59	1.70	198
	—	720	—	283	—	226	—	6	3	6 210	10 100	893			468	679	28.5	5	2.5						0.40	1.68	2.51	1.65	418
441.325	17.3750	660.400	26.0000	195.263	7.6875	138.113	5.4375	10.4	1.6	2 900	5 260	482	EE737173/737261D	1	471	615	28.6	10.4	1.6	0.37	1.80	2.69	1.76	207					
447.675	17.6250	635.000	25.0000	257.175	10.1250	206.375	8.1250	6.4	1.6	4 920	10 500	917	M270749/M270710D	1-P	469	605	25.4	6.4	1.6	0.33	2.03	3.02	1.98	247					
457.200	18.0000	596.900	23.5000	165.100	6.5000	120.650	4.7500	9.5	1.6	2 410	5 230	486	EE244180/244236D 46T916117	1 2-P	485	570	22.2	9.5	1.6	0.40	1.67	2.48	1.63	108					
	18.0000	605.000	23.8189	165.100	6.5000	120.650	4.7500	SP	SP	2 410	5 230	486			489	575	22	6	0.8						0.40	1.67	2.48	1.63	130
460	—	680	—	163	—	145	—	6	3	3 130	5 340	507	46292 46292A 46T926823 46392 46392A	1-P 1-P 1 1-P 1-P	488	637	9	5	2.5	0.37	1.83	2.72	1.78	196					
	—	680	—	204	—	163	—	6	3	4 040	6 850	635			488	646	20.5	5	2.5						0.39	1.74	2.59	1.70	232
	—	680	—	229	—	175	—	6	2.5	4 300	7 390	679			488	645	27	5	2						0.32	2.12	3.15	2.07	251
	—	760	—	240	—	214	—	7.5	4	5 460	9 000	817			496	710	13	6	3						0.39	1.74	2.59	1.70	424
	—	760	—	300	—	240	—	7.5	4	7 130	11 600	1 010			496	718	30	6	3						0.39	1.74	2.59	1.70	506
479.425	18.8750	679.450	26.7500	276.225	10.8750	222.250	8.7500	6.4	1.6	5 940	12 700	1 070	46T966828 M272749/M272710D	2-P 1-P	490	649	27	6.4	1.6	0.33	2.03	3.02	1.98	309					
	18.8750	679.450	26.7500	276.225	10.8750	222.250	8.7500	6.4	1.6	5 310	11 100	952			500	650	27	6.4	1.6						0.33	2.03	3.02	1.98	296
480	—	615	—	120	—	94	—	3	1	1 830	3 620	343	46T966212 46296 46296A 46T967028 46396 46396A	1 1 1 1-P 1-P 1-P	494	590	13	2.5	1	0.35	1.95	2.90	1.91	80.1					
	—	700	—	165	—	147	—	6	3	3 180	5 300	494			508	672	9	5	2.5						0.33	2.03	3.02	1.98	186
	—	700	—	206	—	165	—	6	3	4 040	7 230	666			508	666	20.5	5	2.5						0.33	2.03	3.02	1.98	240
	—	700	—	275	—	200	—	6	3	3 160	10 300	475			508	676	37	5	2.5						0.55	1.24	1.84	1.21	350
	—	790	—	248	—	221	—	7.5	4	5 820	8 920	810			516	742	13.5	6	3						0.39	1.74	2.59	1.70	457
	—	790	—	310	—	248	—	7.5	4	7 530	12 400	1 060			516	749	31	6	3						0.39	1.74	2.59	1.70	560
	—	790	—	310	—	248	—	7.5	4	7 530	12 400	1 060			516	749	31	6	3						0.39	1.74	2.59	1.70	560
482.600	19.0000	615.950	24.2500	184.150	7.2500	146.050	5.7500	6.4	1.6	3 040	7 110	639	LM272249/LM272210D EE243190/243251D	1 1	505	595	19.1	6.4	1.6	0.33	2.03	3.02	1.98	125					
	19.0000	634.873	24.9950	177.800	7.0000	142.875	5.6250	6.4	1.6	2 840	6 590	585			505	610	17.5	6.4	1.6						0.34	1.97	2.93	1.93	143

[Notes] 1) While metric series bearings have minus tolerances for bore and OD, inch series have plus tolerances. Refer to page 194 for details of applicable tolerance standards.

2) SP indicates the specially chamfered form.

Double-row tapered roller bearings

TDO, TDOS type

d 488.671 ~ 546.100 mm

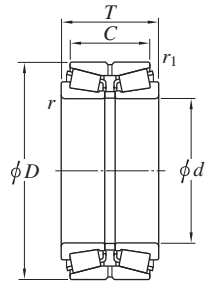

Design 1



Design 1-P



Design 2



Design 2-P

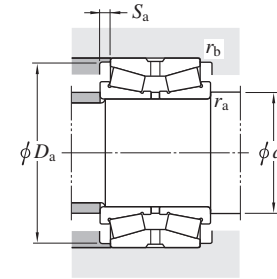

Boundary dimensions										Basic load ratings (kN)		Fatigue load limit (kN)	Bearing No. 1)	Design	Mounting dimensions (mm)					Constant <i>e</i>	Axial load factors			(Refer.) Mass (kg)
<i>d</i> mm	<i>D</i> mm	<i>T</i> mm	<i>C</i> mm	<i>r</i> min.	<i>r</i> ₁ min.	<i>C</i> _r	<i>C</i> _{0r}	<i>C</i> _u	<i>d</i> _a min.	<i>D</i> _a min.	<i>S</i> _a min.	<i>r</i> _a max.			<i>r</i> _b max.	<i>e</i>	<i>Y</i> ₂	<i>Y</i> ₃	<i>Y</i> ₀					
488.671	19.2390	660.400	26.0000	206.375	8.1250	158.750	6.2500	6.4	1.6	3 870	7 910	713	EE640191/640261D	1-P	510	630	23.8	6.4	1.6	0.31	2.20	3.27	2.15	186
488.950	19.2500	634.873	24.9950	180.975	7.1250	136.525	5.3750	6.4	1.6	3 090	6 840	613	LM772748/LM772710D	1	510	615	22.2	6.4	1.6	0.47	1.43	2.12	1.40	135
	19.2500	660.400	26.0000	206.375	8.1250	158.750	6.2500	6.4	1.6	3 870	7 910	713	EE640192/640261D	1-P	510	630	23.8	6.4	1.6	0.31	2.20	3.27	2.15	186
489.026	19.2530	634.873	24.9950	177.800	7.0000	142.875	5.6250	6.4	1.6	2 840	6 590	585	EE243192/243251D	1	510	610	17.5	6.4	1.6	0.34	1.97	2.93	1.93	136
490	—	640	—	179	—	144	—	7.5	2	3 050	6 480	581	46T986418	1	526	615	17.5	6	2	0.37	1.80	2.69	1.76	139
498.475	19.6250	634.873	24.9950	177.800	7.0000	142.875	5.6250	6.4	1.6	2 840	6 590	585	EE243196/243251D	1	520	610	17.5	6.4	1.6	0.34	1.97	2.93	1.93	126
500	—	720	—	167	—	149	—	6	3	3 230	5 690	529	462/500	1-P	528	679	9	5	2.5	0.40	1.71	2.54	1.67	210
	—	720	—	209	—	167	—	6	3	4 390	7 850	712	462/500A	1-P	528	690	21	5	2.5	0.42	1.62	2.41	1.58	258
	—	830	—	264	—	235	—	7.5	4	6 570	10 900	955	463/500	1-P	536	776	14.5	6	3	0.39	1.74	2.59	1.70	559
	—	830	—	330	—	264	—	7.5	4	8 510	14 000	1 170	463/500A	1-P	536	784	33	6	3	0.39	1.74	2.59	1.70	669
506	—	636	—	187	—	147	—	7	2	3 010	7 110	632	2TR506	1	542	620	20	6	2	0.35	1.95	2.90	1.91	126
508.000	20.0000	736.600	29.0000	186.502	7.3426	114.300	4.5000	6.4	1.6	3 160	5 150	475	EE982003/982901D	1-P	530	690	36.1	6.4	1.6	0.48	1.42	2.11	1.39	220
515	—	720	—	140	—	180	—	6	3	3 550	6 550	600	2TR515C3	1-P	540	682	20	5	2.5	0.39	1.74	2.59	1.70	204
520.700	20.5000	736.600	29.0000	186.502	7.3426	114.300	4.5000	6.4	1.6	3 160	5 150	475	EE982051/982901D	1-P	545	690	36.1	6.4	1.6	0.48	1.42	2.11	1.39	205
530	—	780	—	185	—	163	—	6	3	3 820	6 860	619	2TR530D	2-P	550	732	11	5	2.5	0.47	1.43	2.12	1.40	283
	—	780	—	185	—	163	—	6	3	4 310	7 070	643	462/530	1-P	558	744	11	5	2.5	0.39	1.74	2.59	1.70	280
	—	780	—	231	—	185	—	6	3	5 500	9 980	882	462/530A	1-P	558	746	23	5	2.5	0.39	1.74	2.59	1.70	351
533.400	21.0000	812.800	32.0000	269.875	10.6250	187.325	7.3750	9.5	3.2	5 680	11 000	947	EE626210/626321D	1-P	565	760	41.3	9.5	3.2	0.44	1.54	2.29	1.50	459
536.575	21.1250	761.873	29.9950	311.15	12.2500	247.65	9.7500	6.4	1.6	7 060	14 400	1 190	M276449/10CD	2-P	555	726	32	6.4	1.6	0.33	2.03	3.02	1.98	424
546.100	21.5000	736.600	29.0000	165.100	6.5000	114.300	4.5000	6.4	3.2	3 030	6 100	550	EE542215/542291D	1-P	570	705	25.4	6.4	3.2	0.51	1.33	1.97	1.30	181

[Note] 1) While metric series bearings have minus tolerances for bore and OD, inch series have plus tolerances. Refer to page 194 for details of applicable tolerance standards.

Double-row tapered roller bearings

TDO, TDOS type

d 558.800 ~ (609.600) mm

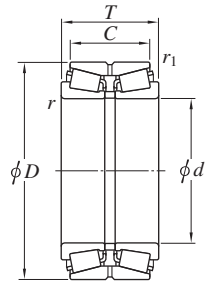

Design 1



Design 1-P



Design 2



Design 2-P

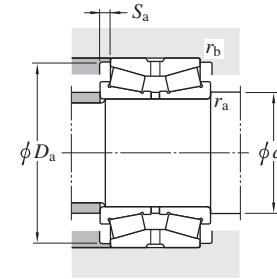

Boundary dimensions										Basic load ratings (kN)		Fatigue load limit (kN)	Bearing No. ¹⁾	Design	Mounting dimensions (mm)					Constant e	Axial load factors			(Refer.) Mass (kg)	
d mm	D mm	T mm	C mm	$r^{2)}$ min.	$r_1^{2)}$ min.	C_r	C_{0r}	C_u		d_a min.	D_a min.	S_a min.			r_a max.	r_b max.	Y_2	Y_3	Y_0						
558.800	22.0000	736.600	29.0000	165.100	6.5000	114.300	4.5000	6.4	3.2	3 030	6 100	550		EE542220/542291D	1-P	580	705	25.4	6.4	3.2	0.51	1.33	1.97	1.30	167
	22.0000	736.600	29.0000	187.328	7.3751	138.113	5.4375	6.4	1.6	3 710	8 050	714			1-P	580	710	24.6	6.4	1.6	0.34	1.97	2.93	1.93	198
	22.0000	736.600	29.0000	225.425	8.8750	160	6.2992	6.4	1.6	4 050	9 180	776			1-P	580	720	32.7	6.4	1.6	0.70	0.97	1.44	0.94	239
	22.0000	736.600	29.0000	225.425	8.8750	177.800	7.0000	6.4	1.6	4 500	9 870	854			1-P	580	710	23.8	6.4	1.6	0.35	1.95	2.90	1.91	240
	22.0000	742.950	29.2500	187.328	7.3751	138.113	5.4375	6.4	1.6	3 710	8 050	714			1-P	580	710	24.6	6.4	1.6	0.34	1.97	2.93	1.93	206
560	—	735	—	225	—	180	—	6	1.5	4 500	9 870	854		46T117423	2-P	588	710	22.5	5	1.5	0.35	1.95	2.90	1.91	236
560.000	22.0472	740.000	29.1339	190.000	7.4803	140.000	5.5118	SP	SP	3 710	8 050	714		2TR560B	1-P	585	715	25	4	0.8	0.34	1.97	2.93	1.93	220
560	—	820	—	195	—	173	—	6	3	4 280	7 940	702		2TR560L	2-P	595	768	11	5	2.5	0.39	1.74	2.59	1.70	336
	—	820	—	195	—	173	—	6	3	4 650	7 990	710		462/560	1-P	588	779	11	5	2.5	0.39	1.74	2.59	1.70	330
	—	820	—	244	—	195	—	6	3	5 970	11 000	960		462/560A	1-P	588	774	24.5	5	2.5	0.33	2.03	3.02	1.98	410
	—	920	—	280	—	246	—	7.5	4	7 530	11 700	1 010		463/560	1-P	596	863	17	6	3	0.39	1.74	2.59	1.70	694
	—	920	—	350	—	280	—	7.5	4	9 830	16 400	1 330		463/560A	1-P	596	869	35	6	3	0.39	1.74	2.59	1.70	856
571.500	22.5000	812.800	32.0000	333.375	13.1250	263.525	10.3750	6.4	1.6	8 150	17 500	1 400		M278749/10D	1-P	600	778	35	6.4	1.6	0.33	2.03	3.02	1.98	526
580	—	800	—	300	—	235	—	7	3	7 210	15 400	1 250		2TR580A	1-P	608	768	32.5	6	2.5	0.33	2.03	3.02	1.98	425
590	—	990	—	400	—	270	—	7.5	2.5	11 200	19 000	1 470		2TR590	1-P	626	940	65	6	2	0.70	0.97	1.44	0.94	1 140
600	—	870	—	200	—	176	—	6	3	4 930	8 290	726		462/600	1-P	628	833	12	5	2.5	0.39	1.74	2.59	1.70	369
	—	870	—	250	—	200	—	6	3	6 680	12 600	1 070		462/600A	1-P	628	826	25	5	2.5	0.33	2.03	3.02	1.98	466
	—	870	—	269	—	198	—	6	2.5	7 080	13 500	1 130		2TR600J	1-P	628	830	35.5	5	2	0.40	1.68	2.50	1.64	494
	—	980	—	300	—	264	—	7.5	4	8 740	13 900	1 170		463/600	1-P	636	920	18	6	3	0.37	1.80	2.69	1.76	850
602.945	23.7380	787.400	31.0000	206.375	8.1250	158.750	6.2500	6.4	1.6	4 260	9 940	840		EE649237/649311D	1-P	625	755	23.8	6.4	1.6	0.37	1.82	2.70	1.78	252
	23.7380	793.750	31.2500	206.375	8.1250	158.750	6.2500	6.4	1.6	4 260	9 940	840		EE649237/649313D	1-P	625	755	23.8	6.4	1.6	0.37	1.82	2.70	1.78	261
609.600	24.0000	787.400	31.0000	206.375	8.1250	158.750	6.2500	6.4	1.6	4 260	9 940	840		EE649240/649311D	1-P	635	755	23.8	6.4	1.6	0.37	1.82	2.70	1.78	241
	24.0000	793.750	31.2500	206.375	8.1250	158.750	6.2500	6.4	1.6	4 260	9 940	840		EE649240/649313D	1-P	635	755	23.8	6.4	1.6	0.37	1.82	2.70	1.78	251

[Notes] 1) While metric series bearings have minus tolerances for bore and OD, inch series have plus tolerances. Refer to page 194 for details of applicable tolerance standards.

2) SP indicates the specially chamfered form.

Double-row tapered roller bearings

TDO, TDOS type

d (609.600) ~ 850 mm

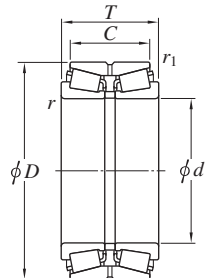

Design 1

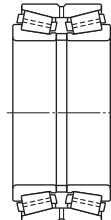

Design 1-P

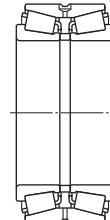

Design 2

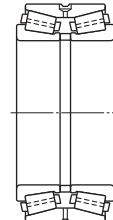

Design 2-P

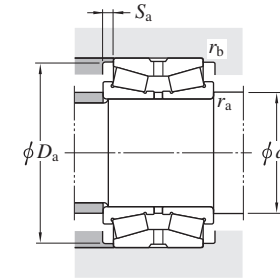

Boundary dimensions										Basic load ratings (kN)		Fatigue load limit (kN)	Bearing No. ¹⁾	Design	Mounting dimensions (mm)					Constant e	Axial load factors			(Refer.) Mass (kg)
d mm	D mm	T mm	C mm	r min.	r_1 min.	C_r	C_{0r}	C_u	d_a min.	D_a min.	S_a min.	r_a max.			r_b max.	e	Y_2	Y_3	Y_0					
609.600	24.0000	812.800	32.0000	190.500	7.5000	146.050	5.7500	6.4	3.2	4 100	8 590	743	EE743240/743321D	1-P	635	770	22.2	6.4	3.2	0.33	2.06	3.06	2.01	250
630	—	800	—	180	—	140	—	6	2	3 720	8 310	708	2TR630	1-P	658	775	20	5	2	0.37	1.80	2.69	1.76	210
	—	920	—	212	—	186	—	7.5	4	5 630	9 550	830	462/630	1-P	666	878	13	6	3	0.39	1.74	2.59	1.70	446
	—	920	—	265	—	212	—	7.5	4	7 350	13 800	1 150	462/630A	1-P	666	874	26.5	6	3	0.33	2.03	3.02	1.98	556
	—	1 030	—	389	—	315	—	7.5	4	12 300	21 600	1 660	463/630A	1-P	666	978	37	6	3	0.39	1.74	2.59	1.70	1 210
670	—	880	—	185	—	130	—	6	2	4 160	8 780	745	2TR670A	1-P	700	843	27.5	5	2	0.45	1.50	2.23	1.46	270
	—	980	—	230	—	202	—	7.5	4	6 090	11 500	966	462/670	1-P	706	931	14	6	3	0.39	1.74	2.59	1.70	568
	—	980	—	288	—	230	—	7.5	4	8 400	15 900	1 280	462/670A	1-P	706	938	29	6	3	0.39	1.74	2.59	1.70	689
682.625	26.8750	965.200	38.0000	396.875	15.6250	311.15	12.2500	9.5	1.6	11 500	25 400	1 910	2TR683-1	2-P	710	926	42.8	9.5	1.6	0.33	2.03	3.02	1.98	886
685.800	27.0000	876.300	34.5000	200.025	7.8750	152.400	6.0000	6.4	1.6	4 400	10 800	880	EE655270/655346D	1-P	710	850	23.8	6.4	1.6	0.42	1.62	2.42	1.59	280
710	—	1 030	—	236	—	208	—	7.5	4	6 580	12 300	1 020	462/710	1-P	746	968	14	6	3	0.39	1.74	2.59	1.70	623
	—	1 030	—	295	—	236	—	7.5	4	8 930	16 600	1 330	462/710A	1-P	746	983	29.5	6	3	0.37	1.80	2.69	1.76	748
	—	1 150	—	393	—	345	—	9.5	5	13 700	24 600	1 800	463/710A	1-P	754	1 098	24	8	4	0.39	1.74	2.59	1.70	1 530
711.200	28.0000	914.400	36.0000	190.500	7.5000	139.700	5.5000	6.4	1.6	3 780	8 930	747	EE755280/755361D	1-P	735	880	25.4	6.4	1.6	0.38	1.78	2.65	1.74	290
723.900	28.5000	914.400	36.0000	187.325	7.3750	139.700	5.5000	3.2	1.6	3 780	8 930	747	EE755285/755361D	1-P	745	880	23.8	3.2	1.6	0.38	1.78	2.65	1.74	266
749.300	29.5000	990.600	39.0000	338.000	13.3071	265.000	10.4331	6.4	3.2	9 820	23 900	1 780	LM283649/LM283610D	1-P	775	960	36.5	6.4	3.2	0.32	2.12	3.15	2.07	681
780	—	1 150	—	330	—	210	—	7.5	2.5	9 520	18 500	1 420	2TR780	1-P	816	1 090	60	6	2	0.70	0.97	1.44	0.94	1 050
800	—	1 150	—	258	—	227	—	7.5	4	8 030	15 500	1 250	462/800	1-P	836	1 104	15.5	6	3	0.39	1.74	2.59	1.70	845
	—	1 150	—	323	—	258	—	7.5	4	10 800	21 100	1 610	462/800A	1-P	836	1 098	32.5	6	3	0.33	2.03	3.02	1.98	1 020
812.800	32.0000	1 016.000	40.0000	190.500	7.5000	146.050	5.7500	6.4	1.6	4 680	10 500	846	EE762320/762401D	1-P	840	980	22.2	6.4	1.6	0.43	1.59	2.36	1.55	321
850	—	1 120	—	266	—	190	—	6	2.5	7 930	17 100	1 340	2TR850D	1-P	878	1 080	38	5	2	0.46	1.47	2.19	1.44	641

[Note] 1) While metric series bearings have minus tolerances for bore and OD, inch series have plus tolerances. Refer to page 194 for details of applicable tolerance standards.

Double-row tapered roller bearings

TDO, TDOS type

d 950 ~ 1 450 mm

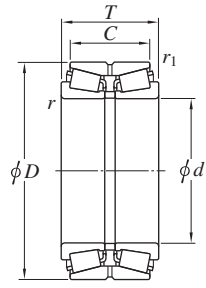

Design 1



Design 1-P



Design 2



Design 2-P

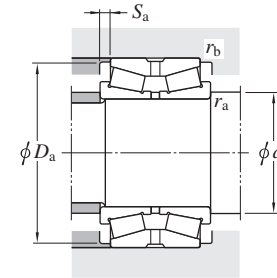

Boundary dimensions										Basic load ratings (kN)		Fatigue load limit (kN)	Bearing No. ¹⁾	Design	Mounting dimensions (mm)					Constant e	Axial load factors			(Refer.) Mass (kg)
d mm	D mm	T mm	C mm	$r^{2)}$ min.	r_1 min.	C_r	C_{0r}	C_u		d_a min.	D_a min.	S_a min.			r_a max.	r_b max.	Y_2	Y_3	Y_0					
950	—	1 250	—	272	—	174	—	SP	3	7 860	17 500	1 250	2TR950B	1-P	986	1 200	49	12	2.5	0.73	0.92	1.37	0.90	786
	—	1 250	—	298	—	220	—	7.5	3	9 600	21 900	1 640			986	1 190	39	6	2.5	0.33	2.03	3.02	1.98	896
	—	1 280	—	280	—	246	—	7.5	4	9 670	20 600	1 570			986	1 220	17	6	3	0.33	2.03	3.02	1.98	986
1 270.000	50.0000	1 435.100	56.5000	146.050	5.7500	101.600	4.0000	6.4	3.2	3 650	11 800	841	LL889049/LL889010D	1	1 300	1 410	22.2	6.4	3.2	0.57	1.18	1.76	1.16	296
1 370	—	1 605	—	210	—	150	—	7.5	4	6 580	18 900	1 340	2TR1370B	1-P	1 406	1 560	30	6	3	0.55	1.24	1.84	1.21	660
1 450	—	1 770	—	290	—	170	—	6	2.5	9 690	25 200	1 740	2TR1450	1-P	1 486	1 703	60	5	2	0.61	1.11	1.66	1.09	1 260

[Notes] 1) While metric series bearings have minus tolerances for bore and OD, inch series have plus tolerances. Refer to page 194 for details of applicable tolerance standards.

2) SP indicates the specially chamfered form.

Double-row tapered roller bearings

TNA type

d 101.600 ~ 174.625 mm

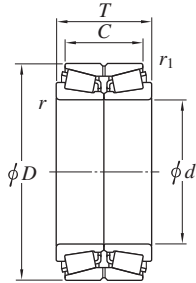

Design 1



Design 2

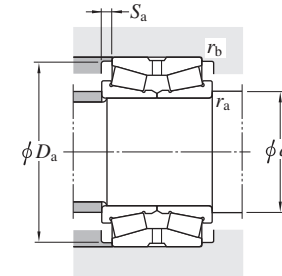

Boundary dimensions										Basic load ratings (kN)		Fatigue load limit (kN)	Bearing No. 1)	Design	Mounting dimensions (mm)					Constant	Axial load factors			Mass (kg)
d mm	D mm	T mm	C mm	r min.	r_1 min.	C_r	C_{0r}	C_u	e	Y_2	Y_3	Y_0			d_a min.	D_a min.	S_a min.	r_a max.	r_b max.					
101.600	4.0000	168.275	6.6250	92.075	3.6250	69.850	2.7500	3.6	0.8	484	698	101	NA691/672D	2	120	156	11.2	3.6	0.8	0.47	1.43	2.14	1.40	7.36
104.775	4.1250	180.975	7.1250	104.775	4.1250	85.725	3.3750	3.6	1.6	620	876	113	NA782/774D	2	123	165	9.6	3.6	1.6	0.39	1.75	2.61	1.71	10.5
114.300	4.5000	190.500	7.5000	106.363	4.1875	80.963	3.1875	3.6	1.6	654	965	122	NA71450/751D	2	133	177	12.7	3.6	1.6	0.42	1.62	2.42	1.59	11.0
	4.5000	212.725	8.3750	142.875	5.6250	117.475	4.6250	3.6	1.6	965	1 350	168	NA938//932D	1	133	192	12.7	3.6	1.6	0.33	2.07	3.09	2.03	21.2
115	—	210	—	143	—	118	—	4	1.5	1 100	1 400	174	46T232114	1	133	201	12.5	3	1.5	0.33	2.07	3.09	2.03	19.4
127.000	5.0000	182.563	7.1875	85.725	3.3750	73.025	2.8750	3.6	0.8	487	858	120	NA48291/48220D	2	145	173	6.4	3.6	0.8	0.31	2.21	3.29	2.16	6.99
	5.0000	206.375	8.1250	107.950	4.2500	82.550	3.2500	3.6	0.8	702	1 100	134	NA798/792D	2	145	194	12.7	3.6	0.8	0.46	1.47	2.19	1.44	13.2
	5.0000	234.950	9.2500	142.875	5.6250	114.300	4.5000	3.6	1.6	1 120	1 650	200	NA95500//95927D	1	145	216	14.3	3.6	1.6	0.37	1.83	2.72	1.79	25.6
133.350	5.2500	215.900	8.5000	106.363	4.1875	80.963	3.1875	3.6	1.6	691	1 100	132	NA74525//74851D	1	152	204	12.7	3.6	1.6	0.49	1.38	2.06	1.35	14.0
136.525	5.3750	190.500	7.5000	85.725	3.3750	73.025	2.8750	3.6	0.8	505	944	129	NA48390//48320D	1	155	181	6.4	3.6	0.8	0.32	2.10	3.13	2.06	7.20
139.700	5.5000	244.475	9.6250	107.950	4.2500	79.375	3.1250	3.6	1.6	694	989	131	NA81550/81963D	2	158	226	14.3	3.6	1.6	0.35	1.93	2.88	1.89	18.8
142.875	5.6250	200.025	7.8750	93.665	3.6876	73.025	2.8750	3.6	0.8	527	982	133	NA48686/48620D	2	161	190	10.3	3.6	0.8	0.34	2.01	2.99	1.96	8.43
146.050	5.7500	236.538	9.3125	131.763	5.1875	106.363	4.1875	3.6	1.6	904	1 460	171	NA82576/82932D	2	164	224	12.7	3.6	1.6	0.44	1.53	2.27	1.49	21.1
	5.7500	241.300	9.5000	131.763	5.1875	106.363	4.1875	3.6	1.6	904	1 460	171	NA82576/82951D	2	164	224	12.7	3.6	1.6	0.44	1.53	2.27	1.49	22.6
149.225	5.8750	236.538	9.3125	131.763	5.1875	106.363	4.1875	3.6	1.6	1 080	1 660	198	HM231149NA/HM231111D	2	168	222	12.7	3.6	1.6	0.32	2.12	3.15	2.07	20.4
152.400	6.0000	244.475	9.6250	107.950	4.2500	79.375	3.1250	3.6	1.6	694	989	131	NA81600/81963D	2	171	226	14.3	3.6	1.6	0.35	1.93	2.88	1.89	16.4
	6.0000	254.000	10.0000	149.225	5.8750	111.125	4.3750	3.6	1.6	1 180	1 830	215	NA99600/99102D	2	171	236	19.1	3.6	1.6	0.41	1.66	2.47	1.62	27.8
165.100	6.5000	288.925	11.3750	142.875	5.6250	111.125	4.3750	3.6	1.6	1 350	1 950	223	HM237536NA/HM237510D	2	184	270	15.9	3.6	1.6	0.32	2.12	3.15	2.07	36.1
165.496	6.5156	225.425	8.8750	95.250	3.7500	69.850	2.7500	3.6	0.8	554	1 140	148	NA46791R/46720D	2	184	215	12.7	3.6	0.8	0.38	1.76	2.62	1.72	10.3
174.625	6.8750	247.650	9.7500	103.188	4.0625	84.138	3.3125	3.6	0.8	741	1 400	160	NA67787//67720D	1	193	237	9.5	3.6	0.8	0.44	1.54	2.29	1.50	14.9

[Note] 1) While metric series bearings have minus tolerances for bore and OD, inch series have plus tolerances. Refer to page 194 for details of applicable tolerance standards.

Double-row tapered roller bearings

TNA type

d 177.800 ~ 406.400 mm

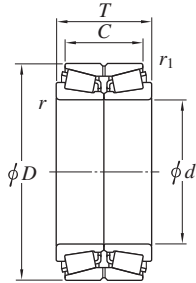

Design 1

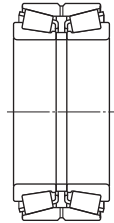

Design 2

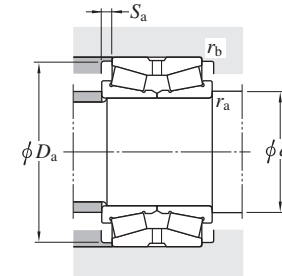

Boundary dimensions										Basic load ratings (kN)		Fatigue load limit (kN)	Bearing No. 1)	Design	Mounting dimensions (mm)					Constant	Axial load factors			Mass (kg)
d mm	D mm	T mm	C mm	r min.	r_1 min.	C_r	C_{0r}	C_u	e	Y_2	Y_3	Y_0			d_a min.	D_a min.	S_a min.	r_a max.	r_b max.					
177.800	7.0000	247.650	9.7500	103.188	4.0625	84.138	3.3125	3.6	0.8	741	1 400	160	NA67790/67720D	2	196	237	9.5	3.6	0.8	0.44	1.54	2.29	1.50	14.2
	7.0000	282.575	11.1250	107.950	4.2500	79.375	3.1250	3.6	1.6	880	1 450	182	NA87700//87112D	1	196	266	14.3	3.6	1.6	0.42	1.62	2.42	1.59	23.5
	7.0000	288.925	11.3750	142.875	5.6250	111.125	4.3750	5.6	1.6	1 180	1 920	216	NA94700//94114D	1	206	269	15.9	5.6	1.6	0.47	1.44	2.15	1.41	33.3
187.325	7.3750	320.675	12.6250	185.738	7.3125	138.113	5.4375	5.6	1.6	1 830	2 530	285	H239649NA/H239612D	2	216	300	23.8	5.6	1.6	0.32	2.12	3.15	2.07	52.7
190.500	7.5000	266.700	10.5000	109.538	4.3125	84.138	3.3125	3.6	0.8	728	1 410	156	NA67885SW//20D	1	209	257	12.7	3.6	0.8	0.48	1.42	2.11	1.38	17.5
203.200	8.0000	317.500	12.5000	120.650	4.7500	88.900	3.5000	6.4	1.6	944	1 450	166	NA132083//132126D	1	232	292	15.9	6.4	1.6	0.31	2.15	3.21	2.11	30.6
	8.0000	317.500	12.5000	146.050	5.7500	111.125	4.3750	5.6	1.6	1 300	2 270	244	NA93800/93127D	2	232	294	17.5	5.6	1.6	0.52	1.29	1.92	1.26	39.3
228.600	9.0000	355.600	14.0000	146.050	5.7500	111.125	4.3750	6.4	1.6	1 560	2 610	280	NA130902/131401D	2	257	330	17.5	6.4	1.6	0.33	2.04	3.04	2.00	49.4
241.300	9.5000	368.300	14.5000	120.650	4.7500	85.725	3.3750	6.4	1.6	1 090	1 850	203	NA170950//171451D	1	270	335	17.5	6.4	1.6	0.36	1.86	2.77	1.82	41.8
244.475	9.6250	349.148	13.7460	133.350	5.2500	101.600	4.0000	6.4	1.6	1 190	2 050	224	NA127096/127136D	2	273	329	15.9	6.4	1.6	0.35	1.91	2.84	1.86	36.3
254.000	10.0000	422.275	16.6250	173.038	6.8125	128.588	5.0625	6.4	1.6	2 180	3 360	355	HM252343NA/HM252311D	2	282	397	22.2	6.4	1.6	0.33	2.03	3.02	1.98	87.2
	10.0000	431.724	16.9970	173.038	6.8125	128.588	5.0625	6.4	1.6	2 180	3 360	355	HM252344NA/HM252315D	2	282	397	22.2	6.4	1.6	0.33	2.03	3.02	1.98	93.5
	10.0000	431.724	16.9970	173.038	6.8125	128.588	5.0625	6.4	1.6	2 110	3 420	352	NA551002/551701D	2	282	388	22.2	6.4	1.6	0.33	2.03	3.02	1.98	93.0
260.350	10.2500	400.050	15.7500	146.050	5.7500	107.950	4.2500	6.4	1.6	1 630	2 570	274	NA221026/221576D	2	289	371	19.1	6.4	1.6	0.39	1.71	2.54	1.67	56.7
	10.2500	422.275	16.6250	173.038	6.8125	128.588	5.0625	6.4	1.6	2 180	3 360	355	HM252349NA/HM252311D	2	289	397	22.2	1.6	1.6	0.33	2.03	3.02	1.98	87.3
	10.2500	431.724	16.9970	173.038	6.8125	128.588	5.0625	6.4	1.6	2 180	3 360	355	HM252349NA/HM252315D	2	289	397	22.2	1.6	1.6	0.33	2.03	3.02	1.98	93.6
304.800	12.0000	444.500	17.5000	139.700	5.5000	98.425	3.8750	6.4	1.6	1 550	2 760	288	NA291201//291751D	1	333	413	20.6	6.4	1.6	0.38	1.79	2.66	1.75	63.8
355.600	14.0000	501.650	19.7500	146.050	5.7500	107.950	4.2500	6.4	1.6	1 700	3 280	322	NA231400//231976D	1	384	480	19.1	6.4	1.6	0.44	1.53	2.28	1.50	82.2
400	—	590	—	185	—	123	—	6	1.5	3 010	5 110	496	46T8059NA-1	1	428	558	31	5	1.5	0.32	2.12	3.15	2.07	148
406.400	16.0000	574.675	22.6250	157.163	6.1875	106.363	4.1875	6.4	1.6	2 040	3 880	367	NA285160//285228D	1	435	535	25.4	6.4	1.6	0.50	1.35	2.01	1.32	112

[Note] 1) While metric series bearings have minus tolerances for bore and OD, inch series have plus tolerances. Refer to page 194 for details of applicable tolerance standards.

Four-row tapered roller bearings

TQO type

d 65 ~ 133.350 mm

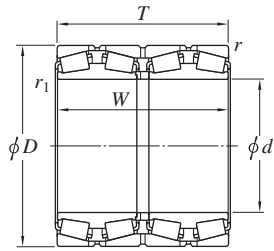

Design 1

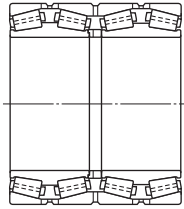

Design 1-P

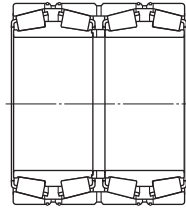

Design 2

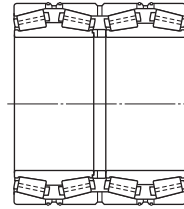

Design 2-P

For oil mist lubrication

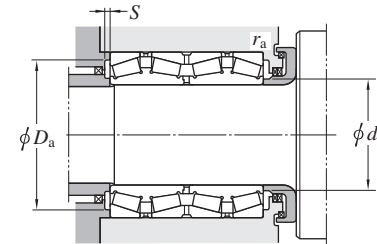

Boundary dimensions								Basic load ratings (kN)		Fatigue load limit	Bearing No. 1)	Design	Mounting dimensions (mm)						Constant e	Axial load factors			(Refer.) Mass (kg)		
d mm	D mm	T mm	W mm	r min.	r_1 min.	C_r	C_{0r}	(kN) C_u	d_a max.	D_a max.			S min.	r_a max.	r_b max.	Y_2	Y_3	Y_0							
65	—	100	—	98	—	98	—	1.5	0.3	388	550	82.3	47T131010	1	73	91.5	87	3.6	1.5	0.3	0.46	1.47	2.19	1.44	2.82
80	—	115	—	88	—	88	—	1.5	1.5	331	543	81.3	47T1611	1	91	106.5	102	3.4	1.5	1.5	0.33	2.03	3.02	1.98	2.99
95	—	130	—	100	—	100	—	1.5	1.5	433	729	107	47T191310	1	104	121.5	117	3.5	1.5	1.5	0.33	2.03	3.02	1.98	3.83
100	—	140	—	104	—	104	—	2	2.5	423	661	96.9	37220	1	112	130	125	3.8	2	2	0.28	2.37	3.53	2.32	4.6
	—	140	—	104	—	104	—	2	1	508	852	124	37220A	1	110	130	125	4.1	2	1	0.40	1.68	2.50	1.64	4.8
	—	170	—	155	—	155	—	2	2.5	989	1 470	213	47T2017	1	119	160	149	5.7	2	2	0.35	1.95	2.90	1.91	14.7
105	—	160	—	150	—	150	—	1.5	1	940	1 420	208	47T211615	1	118	151.5	146	5.9	1.5	1	0.33	2.03	3.02	1.98	10.6
110	—	155	—	114	—	114	—	2	2.5	594	955	138	37222	1	121	145	140	4.8	2	2	0.33	2.03	3.02	1.98	6.45
	—	160	—	115	—	115	—	1.5	1	687	1 030	148	47T221612	1	121	151.5	146	5.2	1.5	1	0.43	1.57	2.34	1.53	7.63
	—	180	—	154	—	154	—	2	2.5	1 110	1 530	218	47T221815	1	127	170	162	5.9	2	2	0.39	1.74	2.59	1.70	15.4
	—	180	—	170	—	170	—	1	1	1 240	1 770	254	47T221817	1	126	174.5	162	6.5	1	1	0.33	2.03	3.02	1.98	17
115	—	155	—	115	—	115	—	1.5	0.6	548	1 020	143	47T231612A	1	126	146.5	142	3.4	1.5	0.6	0.40	1.68	2.50	1.64	6.12
	—	160	—	120	—	120	—	1.5	0.6	701	1 160	166	47T231612	1	124	151.5	147	5.7	1.5	0.6	0.35	1.95	2.90	1.91	7.2
120	—	170	—	124	—	124	—	2	2.5	590	943	133	37224	1	135	160	155	4.1	2	2	0.28	2.37	3.53	2.32	8.56
	—	170	—	130	—	130	—	1.5	2	739	1 290	180	47T241713	1	133	161.5	155	4.4	1.5	2	0.40	1.68	2.50	1.64	9.38
	—	200	—	132	—	132	—	2	2.5	888	1 200	167	47324	1	143	190	178	5.7	2	2	0.35	1.95	2.90	1.91	16.5
	—	210	—	174	—	174	—	2.5	3	1 390	1 770	235	47T242117	1	143	198	188	4	2	2.5	0.33	2.03	3.02	1.98	24.5
120.650	4.7500	161.925	6.3750	106.365	4.1876	106.365	4.1876	1.6	1.6	404	771	105	L624549D/514/514D	1	130	153	147	5.1	1.6	1.6	0.43	1.56	2.32	1.52	6.24
	4.7500	166.688	6.5625	152.414	6.0006	152.400	6.0000	3.3	1.6	795	1 460	206	LM124449D/410/410D	1	132	155	150	2.3	3.3	1.6	0.29	2.30	3.42	2.25	9.84
	4.7500	174.625	6.8750	139.703	5.5001	141.288	5.5625	1.6	0.8	893	1 450	205	M224749D/710/710D	1	133	166	159	4.9	1.6	0.8	0.33	2.03	3.02	1.98	11.1
127.000	5.0000	182.563	7.1875	158.750	6.2500	158.750	6.2500	3.2	1.6	974	1 720	239	48290D/20/20D	1	140	171	166	3.7	3.2	1.6	0.31	2.21	3.29	2.16	13.6
130	—	184	—	134	—	134	—	2	2.5	807	1 330	184	37226	1	143	174	169	4.3	2	2	0.33	2.03	3.02	1.98	11
133.350	5.2500	196.850	7.7500	193.675	7.6250	193.675	7.6250	3.2	1.6	1 340	2 240	275	67390D/22/22D	1	148	185	180	5.6	3.2	1.6	0.34	1.96	2.92	1.92	19.8

[Note] 1) While metric series bearings have minus tolerances for bore and OD, inch series have plus tolerances. Refer to page 194 for details of applicable tolerance standards.

Four-row tapered roller bearings

TQO type
 d 135 ~ 170 mm

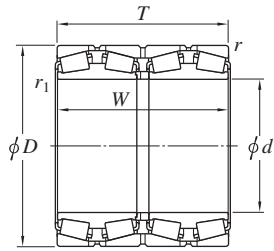

Design 1

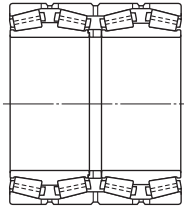

Design 1-P

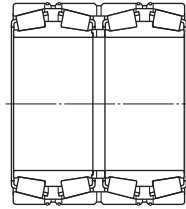

Design 2

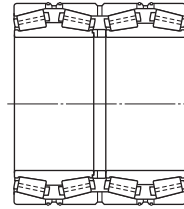

Design 2-P

For oil mist lubrication

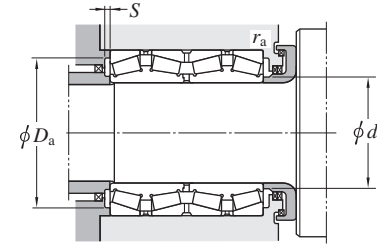

Boundary dimensions								Basic load ratings (kN)		Fatigue load limit (kN)	Bearing No. ¹⁾	Design	Mounting dimensions (mm)						Constant	Axial load factors			(Refer.) Mass (kg)		
d mm	D mm	T mm	W mm	r min.	r_1 min.	C_r	C_{0r}	C_u	d_a max.	D_a max.			S min.	r_a max.	r_b max.	e	Y_2	Y_3	Y_0						
135	—	180	—	160	—	160	—	1.5	1	700	1 290	177	47T271816	1	146	171.5	166	1.4	1.5	1	0.33	2.03	3.02	1.98	10.7
	—	195	—	160	—	160	—	1.5	0.6	1 180	1 930	266		1	147	186.5	179	3.9	1.5	0.6	0.33	2.03	3.02	1.98	15.4
136.525	5.3750	190.500	7.5000	161.925	6.3750	161.925	6.3750	3.2	1.6	1 010	1 890	258	47T271916	2	150	179	174	4.8	3.2	1.6	0.32	2.10	3.13	2.06	14.3
	5.3750	190.500	7.5000	161.925	6.3750	161.925	6.3750	3.2	1.6	1 010	1 890	258		1	150	179	174	4.8	3.2	1.6	0.32	2.10	3.13	2.06	14.3
139.700	5.5000	200.025	7.8750	160.340	6.3126	157.166	6.1876	3.3	0.8	1 050	1 960	266	48680D/20/20D	1	157	187	182	4	3.3	0.8	0.34	2.01	2.99	1.96	16.6
140	—	198	—	144	—	144	—	2	2.5	963	1 650	225	37228	1	157	188	183	5.3	2	2	0.28	2.43	3.61	2.37	13.6
	—	210	—	114	—	114	—	2	2.5	781	1 130	154		1	160	200	190	6	2	2	0.27	2.47	3.67	2.41	13.7
	—	225	—	145	—	145	—	2.5	3	1 220	1 610	205		1	161	213	203	6.5	2	2.5	0.40	1.68	2.50	1.64	21.2
145	—	195	—	130	—	130	—	1.5	0.6	804	1 550	208	47T292013	1	158	186.5	177	5.1	1.5	0.6	0.40	1.68	2.50	1.64	11.1
150	—	210	—	190	—	190	—	2	0.6	1 240	2 270	269	47T302119	1	163	200	190	5	2	0.6	0.39	1.74	2.59	1.70	20.2
	—	212	—	155	—	155	—	2.5	3	968	1 640	220		1	168	200	190	6	2	2.5	0.28	2.37	3.53	2.32	16.7
152.400	6.0000	222.250	8.7500	174.625	6.8750	174.625	6.8750	1.6	1.6	1 360	2 390	318	M231649D/610/610D	1	168	213	201	6	1.6	1.6	0.33	2.03	3.02	1.98	22.8
160	—	226	—	165	—	165	—	2.5	3	1 090	1 870	247	37232	1	178	214	204	6	2	2.5	0.28	2.37	3.53	2.32	20.1
	—	250	—	145	—	145	—	2.5	3	1 370	1 870	232		1	182	238	226	6.5	2	2.5	0.33	2.03	3.02	1.98	25.4
	—	265	—	173	—	173	—	2.5	1	1 660	2 400	293		1	193	253	241	7	2	1	0.35	1.95	2.90	1.91	37.6
165.100	6.5000	225.425	8.8750	168.275	6.6250	165.100	6.5000	3.2	0.8	1 090	2 140	279	46791D/20/21D	1	180	213	203	4.5	3.2	0.8	0.38	1.77	2.63	1.73	19.7
168.275	6.6250	247.650	9.7500	192.088	7.5625	192.088	7.5625	3.2	1.6	1 480	2 800	319	67782D/20/21D	1	189	236	226	5	3.2	1.6	0.44	1.54	2.29	1.50	31.7
170	—	230	—	175	—	175	—	2	1	1 280	2 370	308	47T342318	1	183	220	210	6	2	1	0.40	1.68	2.50	1.64	19.9
	—	240	—	175	—	175	—	2.5	3	1 270	2 310	299		1	189	228	218	5	2	2.5	0.33	2.03	3.02	1.98	24.2
	—	240	—	175	—	175	—	2.5	1.5	1 410	2 340	306		2	184	228	218	7.5	2	1.5	0.40	1.68	2.50	1.64	24.7
	—	260	—	160	—	160	—	2.5	3	1 390	1 900	230		1	194	248	238	6	2	2.5	0.35	1.95	2.90	1.91	28.5
	—	280	—	181	—	181	—	2.5	3	1 670	2 420	291		1	202	268	250	6	2	2.5	0.33	2.03	3.02	1.98	44
	—	280	—	185	—	185	—	2.5	3	1 670	2 420	291		1	202	268	250	6	2	2.5	0.33	2.03	3.02	1.98	44.8
	—	280	—	185	—	185	—	2.5	3	1 670	2 420	291		1	202	268	250	6	2	2.5	0.33	2.03	3.02	1.98	44.8

[Note] 1) While metric series bearings have minus tolerances for bore and OD, inch series have plus tolerances. Refer to page 194 for details of applicable tolerance standards.

Four-row tapered roller bearings

TQO type

d 177.800 ~ 205 mm

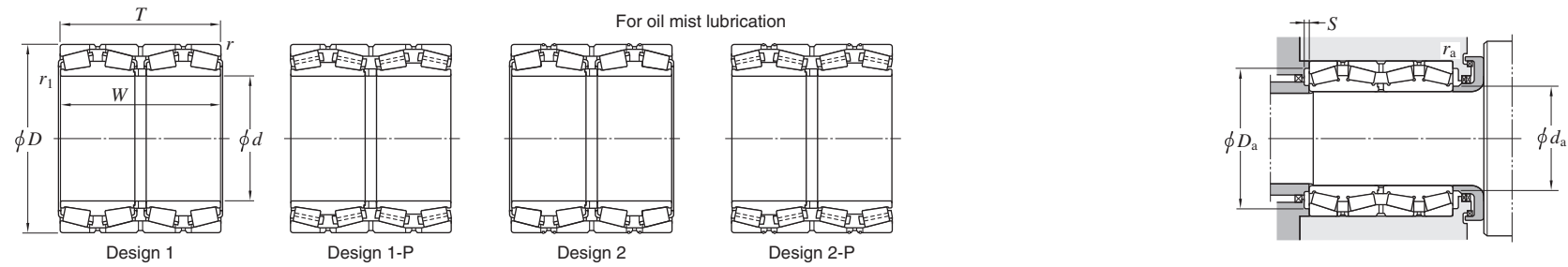

Boundary dimensions								Basic load ratings (kN)		Fatigue load limit (kN)	Bearing No. 1)	Design	Mounting dimensions (mm)						Constant	Axial load factors			(Refer.) Mass (kg)		
d	D	T	W	r	r1	Cr	C0r	Cu	da	Da			S	ra	rb	e	Y2	Y3	Y0	Mass					
mm	1/25.4	mm	1/25.4	mm	1/25.4	mm	1/25.4	min.	min.		max.	max.	min.	min.	max.	max.									
177.800	7.0000	247.650	9.7500	192.088	7.5625	192.088	7.5625	3.2	1.6	1 480	2 800	319	67791D/20/21D 82681D/20/20D EE91700D/112/113XD	1	189	235	225	5	3.2	1.6	0.44	1.54	2.29	1.50	28.4
	7.0000	279.400	11.0000	234.948	9.2499	234.950	9.2500	3.2	1.6	2 080	3 290	373		1	197	267	251	6.5	3.2	1.6	0.52	1.29	1.92	1.26	52.5
	7.0000	285.750	11.2500	222.245	8.7498	222.500	8.7598	3.2	1.6	1 910	2 860	329		1	201	273	251	3.5	3.2	1.6	0.43	1.57	2.34	1.53	53.7
180	—	250	—	185	—	185	—	2.5	3	1 430	2 550	326	47T362519 37236 47T362616 47T362620 47T362818A 47336 47T363028	1	198	238	228	6	2	2.5	0.33	2.03	3.02	1.98	26.9
	—	254	—	185	—	185	—	2.5	3	1 430	2 550	326		1	198	242	232	6	2	2.5	0.33	2.03	3.02	1.98	29.1
	—	260	—	160	—	160	—	2.5	1	1 370	2 090	269		1	198	248	238	5	2	1	0.37	1.80	2.69	1.76	26.4
	—	260	—	200	—	200	—	2	2.5	1 740	2 950	342		1	200	250	240	4.5	2	2	0.31	2.15	3.20	2.10	33.6
	—	280	—	181	—	181	—	2.5	3	1 900	2 830	336		1	204	268	253	8	2	2.5	0.33	2.03	3.02	1.98	40.8
	—	300	—	202	—	202	—	3	4	1 980	2 750	325		1	211	286	267	5.5	2.5	3	0.35	1.95	2.90	1.91	54.9
	—	300	—	280	—	280	—	3	4	3 020	4 430	506		1	211	286	270	6	2.5	3	0.33	2.03	3.02	1.98	78.4
187	—	270	—	210	—	210	—	2.5	1	2 080	3 570	409	47T372721B	1	205	258	248	8	2	1	0.33	2.03	3.02	1.98	39.1
187.325	7.3750	269.875	10.6250	211.138	8.3125	211.138	8.3125	3.2	1.6	1 760	3 220	367	M238849D/810/810D	1	206	257	245	5	3.2	1.6	0.33	2.03	3.02	1.98	39.5
190	—	268	—	196	—	196	—	2.5	3	1 510	2 760	311	37238 47T382716	1	210	256	246	6	2	2.5	0.33	2.03	3.02	1.98	33.4
	—	270	—	160	—	160	—	2.5	1	1 470	2 370	300		1	208	258	248	7	2	1	0.40	1.68	2.50	1.64	28.3
190.000	7.4803	270.000	10.6299	190.000	7.4803	190.000	7.4803	3.2	1.6	1 460	2 810	313	4TR3827	1	208	257	244	6	3.2	1.6	0.48	1.42	2.11	1.38	34.7
190.500	7.5000	266.700	10.5000	188.913	7.4375	187.325	7.3750	3.2	1.6	1 460	2 810	313	67885D/67820/67820D	1	208.5	255.3	245.1	6	3.2	1.6	0.48	1.42	2.11	1.38	32.4
198.438	7.8125	284.163	11.1875	225.425	8.8750	225.425	8.8750	3.2	1.6	2 180	3 780	426	M240648D/611/611D	1	215	271	260	5	3.2	1.6	0.33	2.03	3.02	1.98	44.7
200	—	280	—	206	—	206	—	2.5	1.5	2 080	3 830	435	47T402821 37240 47T403423	1	216	268	258	6.5	2	1.5	0.39	1.71	2.54	1.67	39.7
	—	282	—	206	—	206	—	2.5	3	1 870	3 380	381		1	223	270	260	5.5	2	2.5	0.28	2.43	3.61	2.37	39.6
	—	340	—	234	—	234	—	3	4	2 930	4 150	473		1	234	326	302	6	2.5	4	0.40	1.68	2.50	1.64	86
203.200	8.0000	317.500	12.5000	209.550	8.2500	215.900	8.5000	3.2	3.2	1 890	2 900	333	EE132082D/125/126D 93800D/125/127D	1	235	304	284	7	3.2	3.2	0.31	2.15	3.21	2.11	61
	8.0000	317.500	12.5000	266.700	10.5000	266.700	10.5000	3.2	1.6	2 590	4 540	489		1	223	304	278	6.5	3.2	1.6	0.52	1.29	1.92	1.26	78.8
205	—	320	—	205	—	205	—	3	4	2 180	3 030	350	47T413221	1	230	306	292	7.5	2.5	3	0.46	1.46	2.17	1.42	58.9

[Note] 1) While metric series bearings have minus tolerances for bore and OD, inch series have plus tolerances. Refer to page 194 for details of applicable tolerance standards.

Four-row tapered roller bearings

TQO type
d 206.375 ~ 235 mm

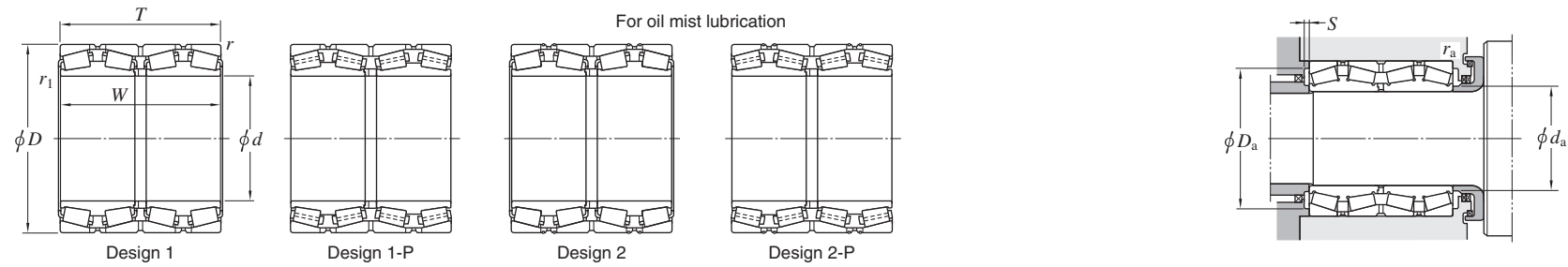

Boundary dimensions								Basic load ratings (kN)		Fatigue load limit (kN)	Bearing No. 1)	Design	Mounting dimensions (mm)						Constant	Axial load factors			(Refer.) Mass (kg)			
<i>d</i>	<i>D</i>		<i>T</i>		<i>W</i>		<i>r</i>	<i>r</i> ₁	<i>C</i> _r	<i>C</i> _{0r}			<i>C</i> _u	<i>d</i> _a	<i>D</i> _a	<i>S</i>	<i>r</i> _a	<i>r</i> _b	<i>e</i>	<i>Y</i> ₂	<i>Y</i> ₃	<i>Y</i> ₀				
mm	1/25.4	mm	1/25.4	mm	1/25.4	mm	1/25.4	min.	min.			max.	max.	min.	min.	max.										
206.375	8.1250	282.575	11.1250	184.150	7.2500	184.150	7.2500	3.2	0.8	1 500	2 830	310														
	8.1250	282.575	11.1250	190.500	7.5000	190.500	7.5000	3.2	0.8	1 500	2 830	310														
	8.1250	282.575	11.1250	210.000	8.2677	210.000	8.2677	3.2	0.8	1 730	3 010	374														
215.090	8.4681	311.150	12.2500	228.600	9.0000	228.600	9.0000	3.2	1.6	2 190	4 040	440														
215.900	8.5000	288.925	11.3750	177.800	7.0000	177.800	7.0000	3.2	0.8	1 530	3 120	381														
	8.5000	336.550	13.2500	266.700	10.5000	266.700	10.5000	3.2	6.4	3 060	4 760	514														
216.103	8.5080	330.200	13.0000	269.875	10.6250	263.525	10.3750	3.2	1.6	3 140	5 120	559														
220	—	300	—	230	—	230	—	2.5	3	2 190	4 040	440														
	—	310	—	226	—	226	—	3	4	2 110	3 880	425														
	—	320	—	201	—	201	—	3	3	2 080	3 760	412														
	—	320	—	250	—	250	—	2.5	3	2 410	4 230	455														
	—	330	—	260	—	260	—	3	1	2 940	5 070	555														
	—	330	—	260	—	260	—	3	1	2 920	4 860	518														
	—	340	—	190	—	190	—	3	4	1 870	2 910	334														
	—	340	—	280	—	280	—	3	1	3 420	5 580	609														
	—	340	—	305	—	305	—	3	4	3 650	5 940	641														
220.662	8.6875	314.325	12.3750	290.000	11.4173	290.000	11.4173	3.2	1.6	2 880	5 050	549														
220.663	8.6875	314.325	12.3750	239.713	9.4375	239.713	9.4375	3.2	1.6	2 630	4 890	538														
225	—	320	—	230	—	230	—	2	2.5	2 090	3 730	407														
228.600	9.0000	311.150	12.2500	200.025	7.8750	200.025	7.8750	3.2	1.6	2 080	3 760	412														
230	—	315	—	190	—	190	—	2	2.5	1 890	3 470	421														
234.950	9.2500	327.025	12.8750	196.850	7.7500	196.850	7.7500	3.2	1.6	2 000	3 720	401														
235	—	325	—	240	—	240	—	2.5	1.5	2 750	5 310	576														

[Note] 1) While metric series bearings have minus tolerances for bore and OD, inch series have plus tolerances. Refer to page 194 for details of applicable tolerance standards.

Four-row tapered roller bearings

TQO type
 d 240 ~ (260) mm

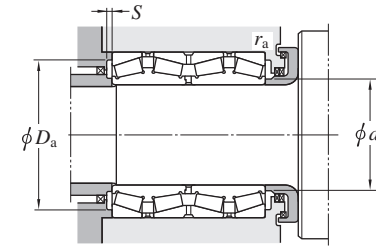
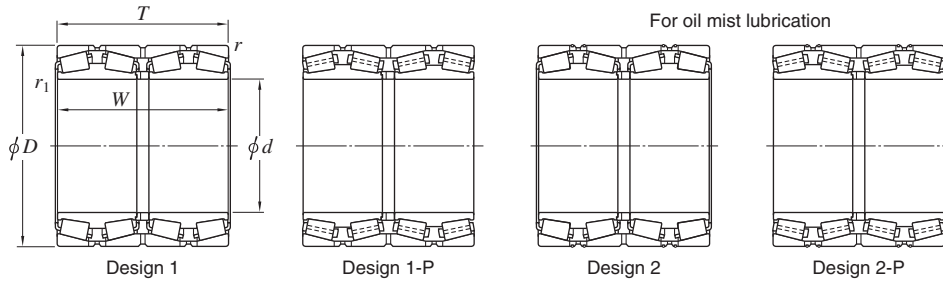

Boundary dimensions								Basic load ratings (kN)		Fatigue load limit (kN)	Bearing No. 1)	Design	Mounting dimensions (mm)						Constant e	Axial load factors			(Refer.) Mass (kg)		
d mm	D mm	T mm	W mm	r min.	r_1 2) min.	C_r	C_{0r}	C_u	d_a max.	D_a max.			S min.	r_a max.	r_b max.	Y_2	Y_3	Y_0							
240	—	320	—	250	—	250	—	2	1	2 350	4 760	507	47T483225B	1	257	310	299	7.5	2	1	0.33	2.03	3.02	1.98	54.2
	—	338	—	248	—	248	—	3	4	2 960	5 360	580	37248	1	259	324	312	8.5	2.5	3	0.39	1.74	2.59	1.70	68.4
	—	338	—	248	—	248	—	3	4	2 960	5 360	580	37248/DP1	2	259	324	312	8.5	2.5	3	0.39	1.74	2.59	1.70	68.4
	—	360	—	194	—	194	—	3	4	2 290	3 580	399	47248	1	272	346	327	8.5	2.5	3	0.32	2.12	3.15	2.07	66.5
	—	360	—	214	—	214	—	3	2.5	2 720	4 340	470	47T483621	1	268	346	328	9	2.5	2.5	0.40	1.68	2.50	1.64	75.4
	—	360	—	308.5	—	308.5	—	3	2.5	4 170	7 400	787	47T483631A	1	268	346	329	9.5	2.5	2.5	0.26	2.55	3.80	2.50	112
	—	365	—	290	—	290	—	2	SP	3 610	5 930	628	47T483729	1	265	355	333	9	2	0.8	0.46	1.47	2.19	1.44	108
	—	410	—	270	—	270	—	4	2.5	4 040	5 520	595	47T484127A	1	281	392	369	8.5	3	2	0.40	1.68	2.50	1.64	144
241.478	9.5070	349.148	13.7460	228.600	9.0000	228.600	9.0000	3.2	1.6	2 750	4 920	529	47T483523A	1	267	335	319	8.5	3.2	1.6	0.35	1.91	2.84	1.86	72.9
	9.5070	349.148	13.7460	228.600	9.0000	228.600	9.0000	3.2	1.6	2 380	4 100	447	EE127097D/135/136D	1	267	335	319	5.5	3.2	1.6	0.35	1.91	2.84	1.86	70.4
244.475	9.6250	327.025	12.8750	193.675	7.6250	193.675	7.6250	3.2	1.6	1 840	3 500	414	47T493319	1	259	313	303	5.5	3.2	1.6	0.55	1.24	1.84	1.21	44.4
	9.6250	327.025	12.8750	193.675	7.6250	193.675	7.6250	3.2	1.6	1 970	3 780	406	LM247748D/710/710D	1	265	313	305	7.5	3.2	1.6	0.32	2.10	3.13	2.06	44.4
	9.6250	381.000	15.0000	304.800	12.0000	304.800	12.0000	4.8	3.2	3 390	5 870	611	EE126096D/150/151D	1	269	364	336	6	4.8	3.2	0.52	1.31	1.95	1.28	129
247.650	9.7500	400.050	15.7500	253.995	9.9998	249.235	9.8124	6.4	1.6	3 270	5 140	548	EE220975D/1575/1576D	1	292	379	359	7.5	6.4	1.6	0.39	1.71	2.54	1.67	123
250	—	350	—	240	—	240	—	2.5	1	2 730	4 970	529	47T503524	1	270	338	324	6	2	1	0.40	1.68	2.50	1.64	70
	—	365	—	270	—	270	—	3	1.5	3 320	6 340	665	47T503627	1	277	351	330	8	2.5	1.5	0.33	2.03	3.02	1.98	96.7
254.000	10.0000	358.775	14.1250	147.000	5.7874	147.000	5.7874	3.2	1.6	1 650	2 910	341	47T513615	1	290	345	331	7	3.2	1.6	0.33	2.03	3.02	1.98	46.9
	10.0000	358.775	14.1250	269.875	10.6250	269.875	10.6250	3.2	1.6	3 320	6 340	665	47T513627A	2	277	345	330	8	3.2	1.6	0.33	2.03	3.02	1.98	85.8
	10.0000	358.775	14.1250	269.875	10.6250	269.875	10.6250	3.2	1.6	3 290	6 030	633	47T513627B	1	272	345	331	7.5	3.2	1.6	0.46	1.47	2.19	1.44	85.5
	10.0000	358.775	14.1250	269.875	10.6250	269.875	10.6250	3.2	1.6	3 290	6 030	633	47T513627C	2	272	345	331	7.5	3.2	1.6	0.46	1.47	2.19	1.44	86.1
	10.0000	358.775	14.1250	269.875	10.6250	269.875	10.6250	3.2	3.2	3 320	6 340	665	M249748D/710/710D	1	277	345	330	8	3.2	3.2	0.33	2.03	3.02	1.98	86
	—	—	—	—	—	—	—	—	—	—	—	—	—	—	—	—	—	—	—	—	—	—	—	—	—
260	—	360	—	272	—	272	—	3	1	3 640	7 020	724	47T523627A	1	280	346	335	9	2.5	1	0.33	2.03	3.02	1.98	83.6
	—	368	—	268	—	268	—	4	5	3 140	6 020	634	37252	1	286	350	338	6	3	4	0.33	2.03	3.02	1.98	88.4
	—	400	—	220	—	220	—	4	1.5	3 000	4 520	489	47T524022	1	295	382	364	7.5	3	1.5	0.40	1.68	2.50	1.64	98.5
	—	400	—	255	—	255	—	7.5	5	3 290	5 400	570	47T524026	1	296	400	360	9	6	4	0.39	1.72	2.56	1.68	113
	—	400	—	320	—	320	—	4	5	4 100	7 070	743	47T524032	1	294	382	361	8.5	3	4	0.33	2.03	3.02	1.98	145
	—	—	—	—	—	—	—	—	—	—	—	—	—	—	—	—	—	—	—	—	—	—	—	—	—

[Notes] 1) While metric series bearings have minus tolerances for bore and OD, inch series have plus tolerances. Refer to page 194 for details of applicable tolerance standards.

2) SP indicates the specially chamfered form.

Four-row tapered roller bearings

TQO type
 d (260) ~ 288.925 mm

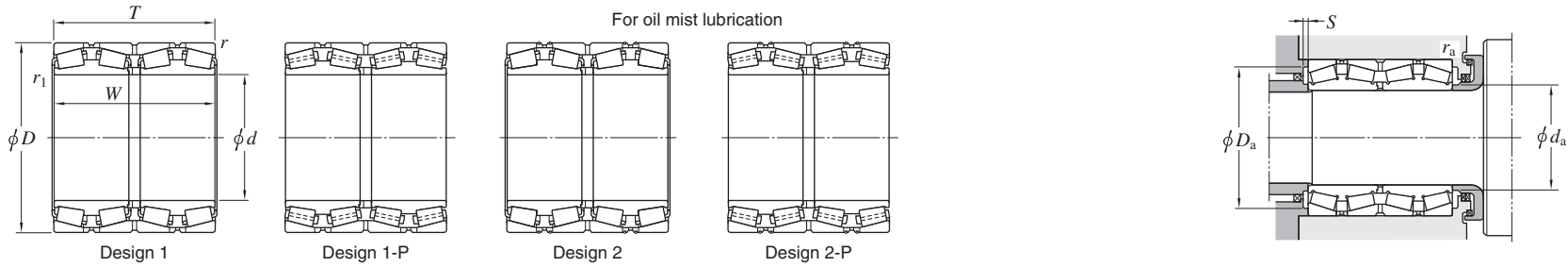

Boundary dimensions								Basic load ratings (kN)		Fatigue load limit (kN)	Bearing No. 1)	Design	Mounting dimensions (mm)						Constant	Axial load factors			(Refer.) Mass (kg)		
d mm	D mm	T mm	W mm	r min.	r_1 min.	C_r	C_{0r}	C_u	d_a max.	D_a max.			S min.	r_a max.	r_b max.	e	Y_2	Y_3	Y_0						
260	—	440	—	300	—	300	—	4	5	4 370	6 880	715	47352	1	311	422	392	10	3	4	0.35	1.95	2.90	1.91	188
260.350	10.2500	422.275	16.6250	317.500	12.5000	314.325	12.3750	3.2	6.4	4 360	6 720	710	HM252348D/310/310D	1	304	407	384	1	3.2	6.4	0.33	2.03	3.02	1.98	167
266.700	10.5000	335.600	13.2126	228.600	9.0000	230.188	9.0625	3.2	1.6	2 330	5 260	552	47T533423	1	281	322	312	7	3.2	1.6	0.28	2.43	3.61	2.37	46.4
	10.5000	355.600	14.0000	228.600	9.0000	230.188	9.0625	3.2	1.6	2 790	5 690	590	47T533623B	1	285	342	332	8	3.2	1.6	0.36	1.87	2.79	1.83	62.7
	10.5000	355.600	14.0000	228.600	9.0000	230.188	9.0625	3.2	1.6	2 480	4 830	507	76589D/20/20D	1	285	342	331	7	3.2	1.6	0.37	1.83	2.73	1.79	59.8
	10.5000	393.700	15.5000	269.878	10.6251	269.878	10.6251	6.4	1.6	3 750	6 460	681	47T533927-1	1	294	373	361	8.5	6.4	1.6	0.40	1.68	2.50	1.64	112
269.875	10.6250	381.000	15.0000	282.575	11.1250	282.575	11.1250	3.2	3.2	3 670	6 690	697	M252349D/310/310D	1	291	367	350	6	3.2	3.2	0.33	2.03	3.02	1.98	98.4
270	—	364	—	260	—	260	—	3	1.5	2 970	5 720	590	47T543626	1	285	350	338	4.5	2.5	1.5	0.42	1.59	2.37	1.56	72.8
	—	410	—	222	—	222	—	4	5	2 820	4 380	474	47254	1	308	392	372	6.5	3	4	0.27	2.51	3.74	2.45	100
276.225	10.8750	393.700	15.5000	269.878	10.6251	269.878	10.6251	6.4	1.6	3 420	5 830	607	47T553927	1	299	373	363	4.5	6.4	1.6	0.40	1.68	2.50	1.64	101
279.400	11.0000	393.700	15.5000	269.875	10.6250	269.875	10.6250	6.4	1.6	3 340	5 990	622	47T563927A	2	305	373	363	9.5	6.4	1.6	0.40	1.68	2.50	1.64	101
	11.0000	393.700	15.5000	269.875	10.6250	269.875	10.6250	6.4	1.6	3 340	5 990	622	47T563927B	1	305	373	363	9.5	6.4	1.6	0.40	1.68	2.50	1.64	101
	11.0000	410.000	16.1417	310.000	12.2047	310.000	12.2047	6.4	1.6	3 910	7 290	745	47T564131	2	308	389	374	8	6.4	1.6	0.40	1.68	2.50	1.64	140
279.578	11.0070	380.898	14.9960	244.475	9.6250	244.475	9.6250	3.2	1.6	2 850	5 650	571	LM654644D/610/610D	1	303	367	356	6.5	3.2	1.6	0.43	1.57	2.34	1.53	80.4
280	—	380	—	290	—	290	—	2	2	3 520	6 940	710	47T563829	1	300	370	354	6	2	2	0.33	2.03	3.02	1.98	91.8
	—	380	—	290	—	290	—	2	1	3 520	6 940	710	47T563829A	2	300	370	354	6	2	1	0.33	2.03	3.02	1.98	92.1
	—	395	—	288	—	288	—	4	2	3 610	6 900	702	37256X	1	303	377	363	8	3	2	0.40	1.68	2.50	1.64	110
	—	395	—	288	—	288	—	4	2	3 610	6 900	702	47T564029A	2	303	377	363	8	3	2	0.40	1.68	2.50	1.64	110
	—	420	—	225	—	225	—	4	5	2 990	4 950	530	47256	1	322	402	382	8.5	3	4	0.25	2.69	4.00	2.63	104
	—	460	—	324	—	324	—	5	6	5 410	8 230	842	47T564632	1-P	321	438	415	10.5	4	5	0.46	1.47	2.19	1.44	214
280.268	11.0342	379.887	14.9562	244.475	9.6250	244.475	9.6250	3.2	1.6	2 850	5 650	571	47T563824	1	303	366	355	6.5	3.2	1.6	0.43	1.57	2.34	1.53	80
285.750	11.2500	380.898	14.9960	244.475	9.6250	244.475	9.6250	3.2	1.6	2 850	5 650	571	LM654648D/610/610D	1	303	367	356	6.5	3.2	1.6	0.43	1.57	2.34	1.53	75.6
288.925	11.3750	406.400	16.0000	298.450	11.7500	298.450	11.7500	3.2	3.2	4 310	8 840	890	M255449D/410/410D	1	316	392	373	9	3.2	3.2	0.34	2.00	2.97	1.95	127

[Note] 1) While metric series bearings have minus tolerances for bore and OD, inch series have plus tolerances. Refer to page 194 for details of applicable tolerance standards.

Four-row tapered roller bearings

TQO type
 d 292.100 ~ (320) mm

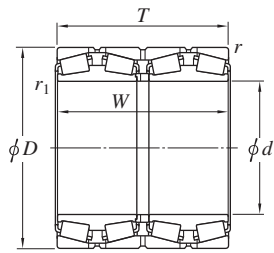

Design 1

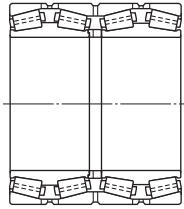

Design 1-P

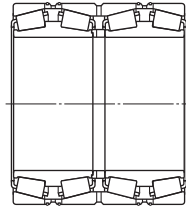

Design 2

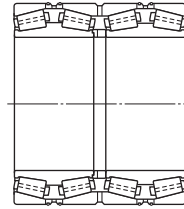

Design 2-P

For oil mist lubrication

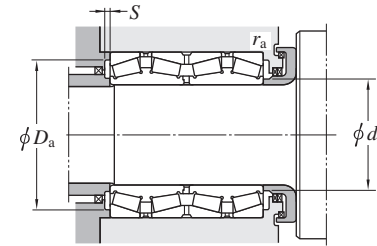

Boundary dimensions								Basic load ratings (kN)		Fatigue load limit (kN)	Bearing No. 1)	Design	Mounting dimensions (mm)						Constant	Axial load factors			(Refer.) Mass (kg)								
d	D	T	W	r	r1 2)	Cr	C0r	Cu	da	Da			S	ra	rb	e	Y2	Y3	Y0	Mass											
mm	mm	mm	mm	mm	mm				max.	max.	min.	max.	max.					(kg)													
292.100	422.275	269.875	269.875	3.2	6.4	3 970	6 830	716											EE330116D/166/167D	1	321	407	387	7.5	3.2	6.4	0.32	2.11	3.14	2.06	124
300	420	310	310	3	1	4 250	8 050	818	325	406	388	8.5	2.5	1	0.34	2.00	2.98	1.96	47T604231	1	325	406	388	8.5	2.5	1	0.34	2.00	2.98	1.96	132
	424	310	310	4	5	3 500	6 570	660	334	406	391	6	3	4	0.28	2.37	3.53	2.32	37260	1	334	406	391	6	3	4	0.28	2.37	3.53	2.32	134
	430	300	300	3	4	4 150	7 630	768	328	416	393	10	2.5	3	0.35	1.95	2.90	1.91	47T604330	1	328	416	393	10	2.5	3	0.35	1.95	2.90	1.91	141
	430	310	310	3	2.5	4 410	8 420	846	332	416	399	10	2.5	2	0.40	1.68	2.50	1.64	47T604331	1	332	416	399	10	2.5	2	0.40	1.68	2.50	1.64	146
	460	248	248	4	1.5	3 840	6 300	651	342	442	416	8.5	3	1.5	0.40	1.68	2.50	1.64	47T604625	1	342	442	416	8.5	3	1.5	0.40	1.68	2.50	1.64	149
	460	360	360	4	5	5 390	9 550	948	339	442	416	9	3	4	0.33	2.03	3.02	1.98	47T604636	1	339	442	416	9	3	4	0.33	2.03	3.02	1.98	220
	470	270	270	4	5	4 400	6 440	669	338	452	426	8	3	4	0.40	1.68	2.50	1.64	47T604727A	1	338	452	426	8	3	4	0.40	1.68	2.50	1.64	165
	470	292	292	4	SP	5 000	7 870	815	341	452	428	8.5	3	2	0.40	1.68	2.50	1.64	47T604729B	1-P	341	452	428	8.5	3	2	0.40	1.68	2.50	1.64	193
	470	292	292	4	1.5	5 190	8 210	847	343	452	428	9.5	3	1.5	0.33	2.03	3.02	1.98	47T604729C	1-P	343	452	428	9.5	3	1.5	0.33	2.03	3.02	1.98	198
	500	350	350	4	2.5	6 280	9 290	948	346	482	451	8	3	2	0.40	1.68	2.50	1.64	47T605035	1	346	482	451	8	3	2	0.40	1.68	2.50	1.64	270
300.038	422.275	311.150	311.150	3.2	3.2	4 250	8 050	818	325	407	388	7	3.2	3.2	0.34	2.00	2.98	1.96	HM256849D/810/810D	1	325	407	388	7	3.2	3.2	0.34	2.00	2.98	1.96	136
304.648	438.048	279.400	280.990	4.8	3.2	4 040	6 980	716	331	420	403	7	4.8	3.2	0.47	1.44	2.15	1.41	47T614428C	2	331	420	403	7	4.8	3.2	0.47	1.44	2.15	1.41	133
	438.048	279.400	280.990	4.8	3.2	4 040	6 980	716	331	420	403	7	4.8	3.2	0.47	1.44	2.15	1.41	M757448D/410/410D	1	331	420	403	7	4.8	3.2	0.47	1.44	2.15	1.41	132
304.800	419.100	269.875	269.875	6.4	1.6	3 540	6 950	699	331	398	387	7	6.4	1.6	0.33	2.03	3.02	1.98	M257149D/110/110D	1	331	398	387	7	6.4	1.6	0.33	2.03	3.02	1.98	110
	482.600	377.825	365.125	6.4	3.2	6 060	9 800	986	343	461	437	1	6.4	3.2	0.47	1.43	2.12	1.40	47T614838A	1-P	343	461	437	1	6.4	3.2	0.47	1.43	2.12	1.40	250
	495.300	349.250	342.900	6.4	3.2	5 480	9 370	922	355	474	438	7	6.4	3.2	0.40	1.68	2.50	1.64	EE724121D/195/196D	1	355	474	438	7	6.4	3.2	0.40	1.68	2.50	1.64	267
304.902	412.648	266.700	266.700	3.2	3.2	3 740	7 280	746	328	398	383	7	3.2	3.2	0.32	2.12	3.15	2.07	M257248D/210/210D	1	328	398	383	7	3.2	3.2	0.32	2.12	3.15	2.07	101
310	430	310	310	3	3	4 410	8 420	846	332	416	399	10	2.5	2.5	0.40	1.68	2.50	1.64	47T624331A	1	332	416	399	10	2.5	2.5	0.40	1.68	2.50	1.64	135
	460	325	325	4	5	5 260	9 500	951	346	442	421	12	3	4	0.32	2.12	3.15	2.07	47T6246A	1	346	442	421	12	3	4	0.32	2.12	3.15	2.07	188
317.500	422.275	269.875	269.875	3.2	1.6	3 660	7 450	747	341	407	392	8.5	3.2	1.6	0.32	2.12	3.15	2.07	LM258649D/610/610D	1	341	407	392	8.5	3.2	1.6	0.32	2.12	3.15	2.07	104
	447.675	327.025	327.025	6.4	1.6	5 160	9 820	976	341	426	411	7.5	6.4	1.6	0.33	2.02	3.00	1.97	47T644533J	1-P	341	426	411	7.5	6.4	1.6	0.33	2.02	3.00	1.97	161
	447.675	327.025	327.025	6.4	1.6	5 360	10 100	995	344	426	411	11.5	6.4	1.6	0.33	2.03	3.02	1.98	47T644533L	1	344	426	411	11.5	6.4	1.6	0.33	2.03	3.02	1.98	161
320	440	335	335	2	2.5	4 500	8 750	877	341	430	408	5.5	2	2	0.40	1.68	2.50	1.64	47T644434	1	341	430	408	5.5	2	2	0.40	1.68	2.50	1.64	149
	460	325	325	4	2.5	5 050	9 420	933	349	442	424	10	3	2.5	0.42	1.62	2.42	1.59	47T644633	1	349	442	424	10	3	2.5	0.42	1.62	2.42	1.59	175

[Notes] 1) While metric series bearings have minus tolerances for bore and OD, inch series have plus tolerances. Refer to page 194 for details of applicable tolerance standards.

2) SP indicates the specially chamfered form.

Four-row tapered roller bearings

TQO type
 d (320) ~ 355.600 mm

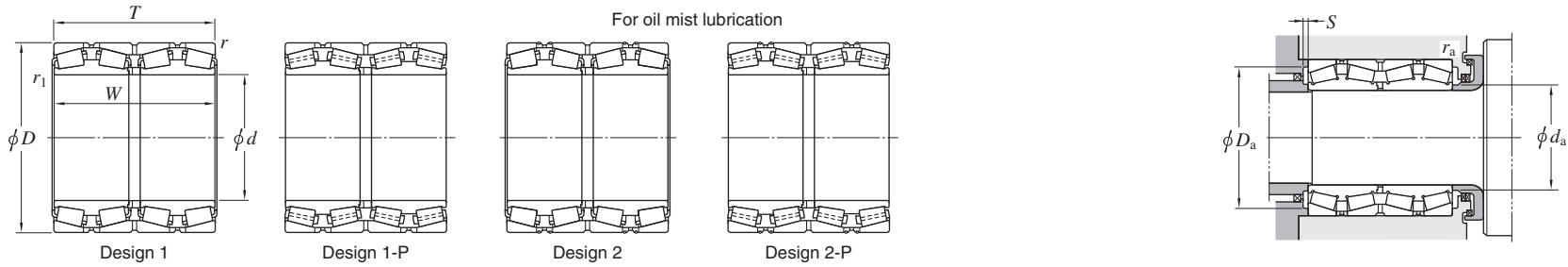

Boundary dimensions								Basic load ratings (kN)		Fatigue load limit (kN)	Bearing No. 1)	Design	Mounting dimensions (mm)						Constant e	Axial load factors			(Refer.) Mass (kg)		
d mm	D mm	T mm	W mm	r min.	r_1 min.	C_r	C_{0r}	C_u	d_a max.	D_a max.			S min.	r_a max.	r_b max.	Y_2	Y_3	Y_0							
320	—	460	—	338	—	338	—	4	5	4 380	8 590	843	37264	1	356	442	421	8.5	3	4	0.33	2.03	3.02	1.98	183
	—	480	—	254	—	254	—	4	2.5	4 260	6 940	709	47T644825	1-P	358	462	437	9	3	2	0.40	1.68	2.50	1.64	161
	—	480	—	260	—	260	—	4	5	4 210	6 890	696	47T644826	1	359	462	437	11.5	3	5	0.40	1.68	2.50	1.64	165
	—	480	—	360	—	360	—	4	1	6 230	11 000	1 070	47T644836-1	1-P	352	462	442	9	3	1	0.47	1.43	2.12	1.40	229
	—	500	—	380	—	380	—	4	1.5	6 970	11 900	1 180	47T645038	1-P	363	482	454	11.5	3	1.5	0.33	2.03	3.02	1.98	284
	—	540	—	364	—	364	—	5	6	6 770	10 600	1 060	47364	1	376	518	479	8.5	4	5	0.32	2.12	3.15	2.07	340
325	—	430	—	230	—	230	—	3	1	3 010	5 800	592	47T654323	1	347	416	401	8.5	2.5	1	0.40	1.68	2.50	1.64	88.5
327	—	445	—	230	—	230	—	3	1	3 280	6 080	621	47T654523	1	353	431	413	9	2.5	1	0.40	1.68	2.50	1.64	102
330.200	13.0000	444.500	17.5000	301.625	11.8750	301.625	11.8750	3.2	3.2	4 440	9 260	920	47T664430	1	357	430	414	10	3.2	3.2	0.26	2.55	3.80	2.50	134
	13.0000	508.000	20.0000	307.975	12.1250	307.975	12.1250	6.4	1.6	5 440	8 500	862	47T665131A	1	372	486	462	8	6.4	1.6	0.33	2.03	3.02	1.98	219
335.000	13.1890	460.000	18.1102	342.900	13.5000	342.900	13.5000	3.2	1.6	4 960	9 390	922	47T674634/DP	2	361	445	428	7.5	3.2	1.6	0.40	1.68	2.50	1.64	165
337.375	13.2825	469.900	18.5000	342.900	13.5000	342.900	13.5000	3.2	1.6	5 800	11 400	1 100	HM261049D/010/010D	1-P	360	455	432	9	3.2	1.6	0.33	2.02	3.01	1.97	190
340	—	480	—	350	—	350	—	5	6	5 890	11 700	1 130	37268A	1-P	371	458	443	9.5	4	6	0.33	2.03	3.02	1.98	198
	—	520	—	278	—	278	—	5	6	5 070	8 110	824	47T685228	1	384	498	473	9	4	6	0.40	1.68	2.50	1.64	212
	—	520	—	323	—	323	—	5	6	5 510	8 930	881	47T685232	1	381	498	473	10	4	5	0.40	1.68	2.50	1.64	242
343.052	13.5060	457.098	17.9960	254.000	10.0000	254.000	10.0000	3.2	1.6	3 560	6 950	680	47T694625	1	363	442	425	6	3.2	1.6	0.47	1.43	2.12	1.40	111
	13.5060	457.098	17.9960	254.000	10.0000	254.000	10.0000	3.2	1.6	3 560	6 950	680	47T694625/DP3	2	363	442	425	6	3.2	1.6	0.47	1.43	2.12	1.40	111
346.075	13.6250	488.950	19.2500	358.775	14.1250	358.775	14.1250	3.2	3.2	5 790	11 600	1 110	HM262749D/10/10D	1	378	474	449	8	3.2	3.2	0.33	2.02	3.00	1.97	214
347.663	13.6875	469.900	18.5000	292.100	11.5000	292.100	11.5000	3.2	3.2	4 490	9 040	879	M262449D/10/10D	1	374	455	436	10	3.2	3.2	0.33	2.03	3.02	1.98	145
355	—	490	—	316	—	316	—	2	2.5	5 200	10 000	982	47T714932	1	385	480	455	12.5	2	2	0.33	2.03	3.02	1.98	180
355.600	14.0000	482.600	19.0000	269.875	10.6250	265.113	10.4375	3.2	1.6	4 240	7 860	795	47T714827-1	1	386	468	450	8	3.2	1.6	0.26	2.55	3.80	2.50	139
	14.0000	482.600	19.0000	269.875	10.6250	265.112	10.4375	3.2	1.6	3 820	7 020	692	LM763449D/410/410D	1	381	468	450	3.5	3.2	1.6	0.47	1.43	2.14	1.40	136
	14.0000	488.950	19.2500	317.500	12.5000	317.500	12.5000	3.2	1.6	5 470	10 900	1 060	M263349D/310/310D	1-P	383	474	452	7.5	3.2	1.6	0.33	2.03	3.02	1.98	182

[Note] 1) While metric series bearings have minus tolerances for bore and OD, inch series have plus tolerances. Refer to page 194 for details of applicable tolerance standards.

Four-row tapered roller bearings

TQO type
d 360 ~ 380 mm

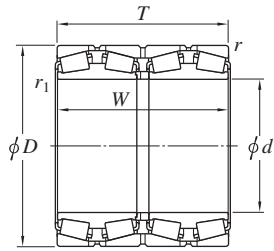

Design 1

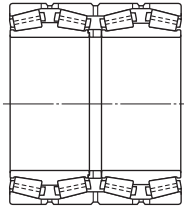

Design 1-P

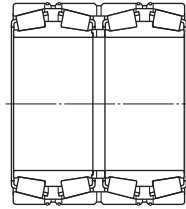

Design 2

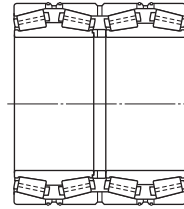

Design 2-P

For oil mist lubrication

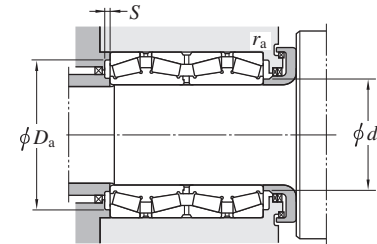

Boundary dimensions										Basic load ratings (kN)		Fatigue load limit (kN)	Bearing No. 1)	Design	Mounting dimensions (mm)						Constant	Axial load factors			(Refer.) Mass (kg)
d	D	T	W	r	r1	Cr	C0r	Cu			da	Da			S	ra	rb	e	Y2	Y3	Y0				
mm	mm	mm	mm	mm	mm						max.	max.	min.	min.	max.										
360	—	480	—	375	—	375	—	3	4	4 900	9 910	962	47T724838A	1	383	466	446	3.5	2.5	3	0.40	1.68	2.50	1.64	177
	—	480	—	375	—	375	—	3	1	5 240	11 100	1 050	47T724838C	1	381	466	448	5	2.5	1	0.33	2.03	3.02	1.98	183
	—	508	—	370	—	370	—	5	6	6 070	11 500	1 100	47T725137	1	392	486	471	7	4	6	0.33	2.03	3.02	1.98	232
	—	520	—	370	—	370	—	5	6	6 170	11 400	1 090	47T725237	1	395	498	476	8.5	4	5	0.33	2.03	3.02	1.98	259
	—	520	—	410	—	410	—	5	6	7 480	14 300	1 350	47T725241	1-P	395	498	479	8.5	4	5	0.33	2.03	3.02	1.98	292
	—	540	—	280	—	280	—	5	6	4 740	7 820	786	47272	1	406	518	490	10	4	5	0.32	2.12	3.15	2.07	221
	—	540	—	280	—	280	—	5	6	4 710	8 000	777	47T725428	1	402	518	489	10.5	4	5	0.55	1.24	1.84	1.21	224
	—	540	—	460	—	460	—	4	5	8 070	15 800	1 450	47T7254	1	408	522	492	9.5	3	4	0.27	2.47	3.67	2.41	373
368.300	14.5000	523.875	20.6250	382.588	15.0625	382.588	15.0625	6.4	3.2	6 930	13 600	1 300	47T745238B	1-P	404	502	483	9	6.4	3.2	0.29	2.32	3.45	2.26	269
	14.5000	523.875	20.6250	382.588	15.0625	382.588	15.0625	3.2	1.6	7 050	14 100	1 320	47T745238D	1	403	508	483	7.5	3.2	1.6	0.33	2.03	3.02	1.98	265
	14.5000	523.875	20.6250	382.588	15.0625	382.588	15.0625	6.4	3.2	7 420	14 500	1 360	47T745238J	1-P	401	502	485	10.5	6.4	3.2	0.33	2.03	3.02	1.98	268
	14.5000	523.875	20.6250	382.588	15.0625	382.588	15.0625	6.4	3.2	6 840	13 600	1 290	HM265049D/010/010D	1-P	403	502	483	7	6.4	3.2	0.33	2.03	3.02	1.98	269
	14.5000	563.000	22.1654	382.588	15.0625	382.588	15.0625	6.4	3.2	7 920	13 600	1 320	47T745638	1-P	417	541	516	10.5	6.4	3.2	0.29	2.32	3.45	2.26	344
370	—	516	—	346	—	346	—	4	1.5	6 110	11 700	1 120	47T745235	1-P	398	498	479	9	3	1.5	0.40	1.68	2.50	1.64	216
374.650	14.7500	501.650	19.7500	260.350	10.2500	260.350	10.2500	3.2	1.6	3 680	7 750	737	47T745026	1	399	486	459	7	3.2	1.6	0.43	1.56	2.32	1.52	145
380	—	520	—	360	—	360	—	5	6	5 760	12 200	1 140	47T765236	1	417	498	484	11	4	5	0.32	2.12	3.15	2.07	225
	—	520	—	400	—	400	—	4	2.5	6 270	13 000	1 200	47T765240	1	404	502	482	9.5	3	2	0.40	1.68	2.50	1.64	248
	—	536	—	390	—	390	—	5	6	6 740	12 900	1 220	37276	1	415	514	496	7.5	4	5	0.40	1.68	2.50	1.64	268
	—	560	—	282	—	282	—	5	6	4 600	7 580	741	47276	1	429	538	511	9	4	5	0.27	2.47	3.67	2.41	232
	—	560	—	285	—	285	—	4	5	5 760	10 000	983	47T765629	1-P	428	542	513	11	3	4	0.27	2.47	3.67	2.41	246
	—	560	—	285	—	285	—	4	5	5 540	9 240	919	47T765629A	1	427	542	515	11	3	5	0.27	2.47	3.67	2.41	244
	—	560	—	325	—	325	—	5	6	6 680	11 900	1 150	47T765633A	1-P	427	538	514	11	4	5	0.27	2.47	3.67	2.41	278
	—	560	—	360	—	390	—	4	1.5	6 650	11 800	1 120	47T765639	1	422	542	514	9	3	1.5	0.35	1.95	2.90	1.91	307
	—	560	—	370	—	370	—	5	6	7 400	13 600	1 300	47T765637	1-P	423	538	515	10	4	5	0.33	2.03	3.02	1.98	312
	—	580	—	500	—	500	—	5	6	9 290	17 500	1 570	47T765850	1	427	558	529	10.5	4	5	0.33	2.03	3.02	1.98	478
	—	620	—	400	—	400	—	5	6	7 710	12 700	1 210	47376	1	445	598	552	6.5	4	5	0.32	2.12	3.15	2.07	476
	—	620	—	418.5	—	418.5	—	5	6	8 900	14 000	1 330	47T766242	1-P	435	598	561	10	4	5	0.46	1.47	2.19	1.44	499

[Note] 1) While metric series bearings have minus tolerances for bore and OD, inch series have plus tolerances. Refer to page 194 for details of applicable tolerance standards.

Four-row tapered roller bearings

TQO type

d 384.175 ~ (431.800) mm

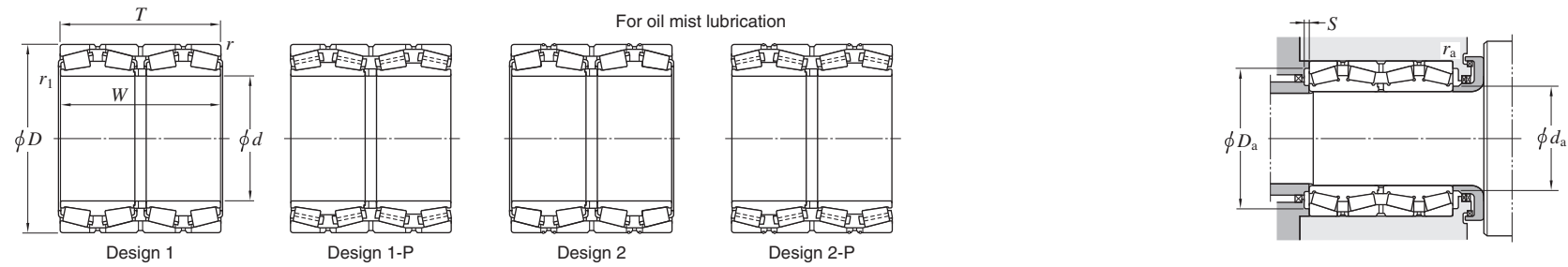

Boundary dimensions								Basic load ratings (kN)		Fatigue load limit (kN)	Bearing No. 1)	Design	Mounting dimensions (mm)						Constant <i>e</i>	Axial load factors			(Refer.) Mass (kg)		
<i>d</i> mm	<i>D</i> mm	<i>T</i> mm	<i>W</i> mm	<i>r</i> min.	<i>r</i> ₁ min.	<i>C</i> _r	<i>C</i> _{0r}	<i>C</i> _u	<i>d</i> _a max.	<i>D</i> _a max.			<i>S</i> min.	<i>r</i> _a max.	<i>r</i> _b max.	<i>Y</i> ₂	<i>Y</i> ₃	<i>Y</i> ₀							
384.175	15.1250	546.100	21.5000	400.050	15.7500	400.050	15.7500	6.4	3.2	8 180	16 900	1 550	HM266449D/410/410D 47T775547	1-P 1	418	524	502	10.5	6.4	3.2	0.33	2.03	3.02	1.98	315
	15.1250	546.100	21.5000	470.000	18.5039	470.000	18.5039	6.4	3.2	7 790	16 200	1 460			418	524	503	7.5	6.4	3.2					
390	—	510	—	350	—	350	—	3	1.5	5 380	11 700	1 090	47T785135A 47T785135B	1 1	413	496	478	10.5	2.5	1.5	0.33	2.03	3.02	1.98	186
	—	510	—	350	—	350	—	3	1	5 190	11 200	1 050			415	496	479	5.5	2.5	1					
395	—	545	—	288.7	—	270.3	—	7.5	5	4 160	7 680	744	47T795529	1	433	509	494	3	6	4	0.43	1.57	2.34	1.53	190
400	—	560	—	380	—	380	—	4	1.5	7 480	15 200	1 410	47T805638A	1-P	435	542	519	10	3	1.5	0.33	2.03	3.02	1.98	296
	—	564	—	412	—	412	—	4	2.5	8 110	16 500	1 500	47T805641	1-P	432	546	522	9	3	2.5	0.40	1.68	2.50	1.64	329
	—	590	—	304	—	304	—	4	1.5	5 960	10 200	997	47T805930A	1-P	449	572	540	7.5	3	1.5	0.33	2.03	3.02	1.98	289
	—	600	—	308	—	308	—	5	6	6 040	9 930	956	47280	1	452	578	548	9	4	5	0.33	2.03	3.02	1.98	310
406.400	16.0000	546.100	21.5000	288.925	11.3750	288.925	11.3750	6.4	1.6	4 950	9 540	906	47T815529	1	435	524	509	9.5	6.4	1.6	0.47	1.43	2.12	1.40	184
	16.0000	546.100	21.5000	330.000	12.9921	330.000	12.9921	6.4	3.2	6 000	12 400	1 160	47T815533B	1-P	434	524	509	8.5	6.4	3.2	0.40	1.68	2.50	1.64	214
	16.0000	562.000	22.1260	381.000	15.0000	381.000	15.0000	6.4	3.2	7 510	15 000	1 390	47T815638	1	439	540	524	9.5	6.4	3.2	0.33	2.03	3.02	1.98	284
	16.0000	565.150	22.2500	381.000	15.0000	381.000	15.0000	6.4	3.2	7 510	15 000	1 390	M267949D/910/910XD	1	438.3	544	524	9.5	6.4	3.2	0.33	2.03	3.02	1.98	291
409.575	16.1250	546.100	21.5000	334.963	13.1875	334.963	13.1875	6.4	1.6	5 710	11 500	1 080	M667947D/911/911D	1	432	524	509	8.5	6.4	1.6	0.42	1.62	2.42	1.59	213
415.925	16.3750	590.550	23.2500	434.975	17.1250	434.975	17.1250	6.4	3.2	8 840	18 800	1 680	47T835943A	1-P	455	568	543	10	6.4	3.2	0.33	2.03	3.02	1.98	391
420	—	560	—	370	—	370	—	5	6	6 200	13 600	1 240	47T845637	1	459	538	527	12	4	5	0.32	2.12	3.15	2.07	252
	—	560	—	437	—	437	—	4	1.5	7 020	14 900	1 380	47T845644	1	450	542	526	4	3	1.5	0.26	2.55	3.80	2.50	283
	—	592	—	432	—	432	—	5	6	7 540	15 700	1 410	37284	1	460	570	544	7.5	4	5	0.33	2.03	3.02	1.98	374
	—	650	—	460	—	460	—	6	6	10 800	18 300	1 660	47T846546	1	468	622	595	8.5	5	5	0.40	1.68	2.50	1.64	558
430	—	570	—	336	—	336	—	4	1.5	5 990	12 500	1 150	47T865734C	1	460	552	536	10	3	1.5	0.36	1.87	2.79	1.83	232
	—	570	—	380	—	380	—	4	1.5	7 060	15 900	1 440	47T865738	1	463	552	534	10.5	3	1.5	0.26	2.55	3.80	2.50	269
431.800	17.0000	571.500	22.5000	336.550	13.2500	336.550	13.2500	6.4	1.6	6 340	13 500	1 240	47T865734	1-P	460	549	534	10	6.4	1.6	0.36	1.87	2.79	1.83	232
	17.0000	571.500	22.5000	336.550	13.2500	336.550	13.2500	6.4	1.6	5 380	11 300	1 040	LM769349D/310/310D	1	463	549	534	7	6.4	1.6	0.48	1.41	2.10	1.38	231

[Note] 1) While metric series bearings have minus tolerances for bore and OD, inch series have plus tolerances. Refer to page 194 for details of applicable tolerance standards.

Four-row tapered roller bearings

TQO type

d (431.800) ~ 479.425 mm

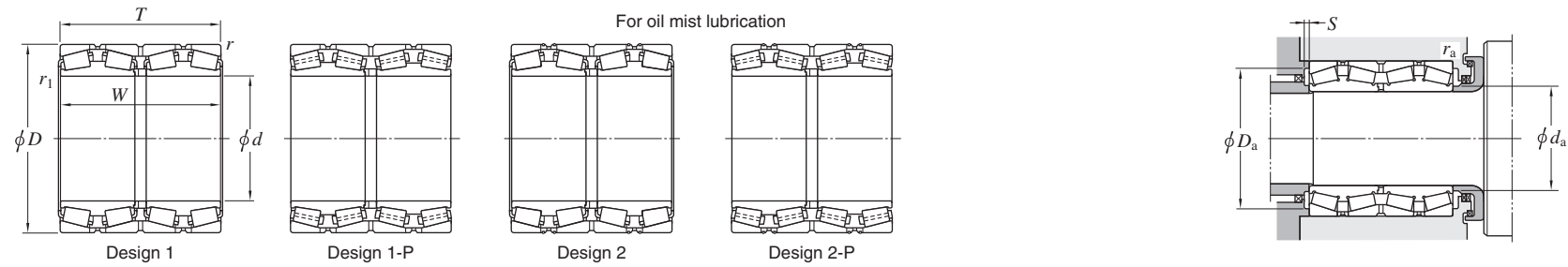

Boundary dimensions								Basic load ratings (kN)		Fatigue load limit (kN)	Bearing No. ¹⁾	Design	Mounting dimensions (mm)						Constant e	Axial load factors			(Refer.) Mass (kg)
d mm	D mm	T mm	W mm	r min.	r_1 min.	C_r	C_{0r}	C_u	d_a max.	D_a max.			S min.	r_a max.	r_b max.	Y_2	Y_3	Y_0					
431.800	635.000	355.600	355.600	6.4	6.4	7 910	13 700	1 290	EE931170D/250/251XD	1-P	481	612	586	8	6.4	6.4	0.32	2.10	3.13	2.06	385		
432.003	609.524	317.500	317.500	6.4	3.6	6 520	12 100	1 130	EE736173D/238/239D	1-P	474	586	562	9	6.4	3.6	0.35	1.94	2.89	1.90	291		
440	580	420	420	4	1.5	7 150	15 400	1 420	47T885842	1-P	467	562	544	1.5	3	1.5	0.26	2.55	3.80	2.50	288		
	620	454	454	6	6	8 900	17 500	1 560	37288	1	482	592	576	9	5	5	0.40	1.68	2.50	1.64	417		
	620	454	454	4	5	9 530	19 800	1 730	47T886246	1-P	474	602	573	10.5	3	5	0.40	1.68	2.50	1.64	436		
	635	430	430	5	6	9 470	18 000	1 630	47T886443	1-P	485	613	587	9.5	4	5	0.33	2.03	3.02	1.98	450		
	635	470	470	5	2.5	10 700	20 900	1 840	47T886447	1-P	483	613	588	10.5	4	2	0.33	2.03	3.02	1.98	500		
	650	326	326	6	6	6 370	11 000	1 020	47288	1-P	500	622	595	11	5	5	0.28	2.43	3.61	2.37	361		
	650	334	334	6	6	6 880	12 200	1 130	47288A	1	500	622	595	9.5	5	5	0.28	2.43	3.61	2.37	375		
	660	450	450	5	2	10 900	19 000	1 720	47T886645	1	489	638	610	9.5	4	2	0.32	2.12	3.15	2.07	532		
447.675	635.000	463.550	463.550	6.4	3.2	9 840	21 000	1 830	M270749D/710/710D	1-P	491	612	584	8	6.4	3.2	0.33	2.03	3.02	1.98	472		
449.949	594.949	368.000	368.000	5	2.5	7 470	16 200	1 470	M270449D/10/10D	1-P	478	573	557	9	5	2	0.33	2.03	3.02	1.98	278		
450	580	450	450	6	1.5	6 440	14 600	1 320	47T905845	1	475	552	537	2	5	1.5	0.26	2.55	3.80	2.50	286		
457.200	596.900	279.400	276.225	3.2	1.6	5 350	11 400	1 050	47T916028A	1-P	485	581	560	8.5	3.2	1.6	0.47	1.43	2.12	1.40	307		
	660.400	323.847	323.850	6.4	3.2	7 140	12 700	1 180	EE737179D/260/261D	1-P	501	637	603	9	6.4	3.2	0.37	1.80	2.69	1.76	365		
460	586	280	280	3	1	4 650	9 810	915	47T925928	1	483	572	555	10.5	2.5	1	0.44	1.52	2.26	1.49	177		
	615	360	360	3	1	6 260	13 300	1 210	47T926236	1	490	601	572	8	2.5	1	0.47	1.43	2.12	1.40	292		
	625	421	421	4	1.5	8 640	18 800	1 670	47T926342	1-P	495	607	582	8	3	1.5	0.33	2.03	3.02	1.98	386		
	650	474	474	6	6	9 420	19 400	1 690	37292	1	500	622	598	8	5	5	0.33	2.03	3.02	1.98	495		
	680	375	375	5	2	8 150	15 200	1 370	47T926838	1	515	658	618	10.5	4	2	0.36	1.87	2.79	1.83	475		
	730	440	440	6	3	10 900	17 700	1 610	47T927344	1-P	519	702	662	13	5	2.5	0.47	1.43	2.12	1.40	710		
475.000	600.000	368.000	368.000	4.8	1.6	6 240	15 100	1 350	47T956037A	1	501	581	566	10.5	4.8	1.6	0.26	2.55	3.80	2.50	246		
479.425	679.450	495.300	495.300	6.4	3.2	12 100	25 400	2 150	47T966850	1-P	523	656	641	12.5	6.4	3.2	0.33	2.03	3.02	1.98	591		
	679.450	495.300	495.300	6.4	3.2	10 600	22 200	1 900	M272749D/710/710D	1-P	524	656	627	7.5	6.4	3.2	0.33	2.03	3.02	1.98	575		

[Note] 1) While metric series bearings have minus tolerances for bore and OD, inch series have plus tolerances. Refer to page 194 for details of applicable tolerance standards.

Four-row tapered roller bearings

TQO type
d 480 ~ (508.000) mm

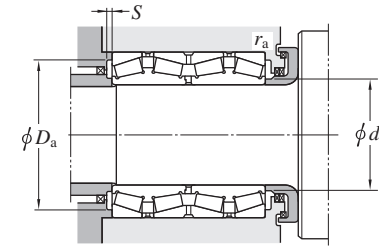
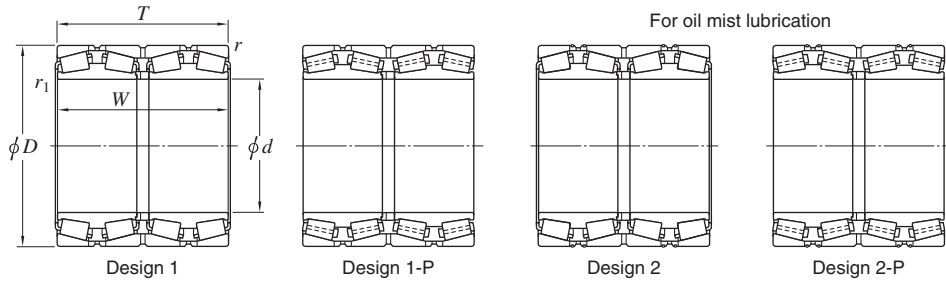

Boundary dimensions										Basic load ratings (kN)		Fatigue load limit (kN)	Bearing No. ¹⁾	Design	Mounting dimensions (mm)						Constant	Axial load factors			(Refer.) Mass (kg)
<i>d</i> mm	<i>D</i> mm	<i>T</i> mm	<i>W</i> mm	<i>r</i> min.	<i>r</i> ₁ ²⁾ min.	<i>C</i> _r	<i>C</i> _{0r}	<i>C</i> _u	<i>d</i> _a max.	<i>D</i> _a max.	<i>S</i> min.	<i>r</i> _a max.			<i>r</i> _b max.	<i>e</i>	<i>Y</i> ₂	<i>Y</i> ₃	<i>Y</i> ₀						
480	—	678	—	494	—	494	—	6	6	11 500	23 300	2 000	37296	1-P	520	650	629	9.5	5	5	0.33	2.03	3.02	1.98	563
	—	700	—	390	—	390	—	5	6	9 270	16 800	1 520			47T967039	1-P	536	678	647	11	4	6	0.33	2.03	3.02
480.000	18.8976	700.000	27.5591	420.000	16.5354	420.000	16.5354	6.4	3.2	10 100	18 800	1 680	47T967042C	1	531	677	644	10.5	6.4	3.2	0.35	1.95	2.90	1.91	540
482.600	19.0000	615.950	24.2500	330.200	13.0000	330.200	13.0000	6.4	6.4	6 060	13 400	1 220	47T976233	2-P	512	593	573	6	6.4	6.4	0.44	1.54	2.30	1.51	240
	19.0000	615.950	24.2500	330.200	13.0000	330.200	13.0000	6.4	6.4	6 060	13 400	1 220	4TR19A	1-P	512	593	573	6.5	6.4	6.4	0.44	1.54	2.30	1.51	240
	19.0000	615.950	24.2500	330.200	13.0000	330.200	13.0000	6.4	4.8	6 610	15 000	1 340	4TR19B	1-P	509	593	573	10.5	6.4	4.8	0.33	2.03	3.02	1.98	243
	19.0000	615.950	24.2500	330.200	13.0000	330.200	13.0000	6.4	3.2	6 540	15 000	1 330	4TR19D	1	508	593	573	10	6.4	3.2	0.36	1.87	2.79	1.83	240
	19.0000	615.950	24.2500	420.000	16.5354	420.000	16.5354	4	2.5	7 290	16 700	1 480	47T976242	1	508	597	577	6	4	2.5	0.26	2.55	3.80	2.50	296
	19.0000	647.700	25.5000	417.512	16.4375	417.512	16.4375	6.4	3.2	9 230	20 300	1 770	47T976542A	2-P	514	624	603	9.5	6.4	3.2	0.33	2.03	3.02	1.98	397
	19.0000	647.700	25.5000	417.512	16.4375	417.512	16.4375	6.4	3.2	9 230	20 300	1 770	M272647D/610/610D	1-P	514	624	604	9.5	6.4	3.2	0.33	2.03	3.02	1.98	395
	19.2500	622.300	24.5000	365.125	14.3750	365.125	14.3750	3.6	3.6	6 210	13 900	1 240	47T986236	1	516	605	585	7.5	3.6	3.6	0.33	2.03	3.02	1.98	262
19.2500	660.400	26.0000	361.950	14.2500	365.125	14.3750	6.4	7.9	7 750	15 800	1 430	EE640193D/260/261D	1-P	527	637	616	11	6.4	7.9	0.31	2.20	3.27	2.15	357	
489.026	19.2530	634.873	24.9950	320.675	12.6250	320.675	12.6250	3.2	3.2	5 680	13 200	1 170	EE243193D/250/251D	1	526	618	595	9.5	3.2	3.2	0.34	1.97	2.93	1.93	263
	19.2530	634.873	24.9950	320.675	12.6250	320.675	12.6250	3.2	3.2	6 180	13 700	1 230	LM772749D/710/710D	1	513	618	594	9.5	3.2	3.2	0.47	1.43	2.12	1.40	261
490	—	625	—	385	—	385	—	4	1.5	7 140	17 200	1 510	47T986339A	1	520	607	587	9.5	3	1.5	0.28	2.43	3.61	2.37	290
	—	625	—	385	—	385	—	4	1.5	6 950	16 600	1 460	47T986339B	1	517	607	587	4.5	3	1.5	0.32	2.12	3.15	2.07	285
500	—	640	—	450	—	450	—	4	1.5	8 820	20 300	1 770	4TR500M	2-P	527	622	602	10.5	3	1.5	0.24	2.84	4.23	2.78	352
	—	670	—	515	—	515	—	5	6	11 400	25 700	2 160	4TR500B	1-P	530	648	626	11	4	5	0.32	2.12	3.15	2.07	510
	—	705	—	515	—	515	—	6	SP	11 900	24 500	2 070	372/500	1-P	544	677	651	8.5	5	6	0.37	1.80	2.69	1.76	641
	—	710	—	430	—	425	—	5	3	10 200	20 000	1 750	4TR500T	1	547	688	658	12	4	3	0.37	1.80	2.69	1.76	528
	—	720	—	400	—	400	—	6	6	10 000	18 700	1 680	4TR500J	1-P	552	692	663	12.5	5	5	0.33	2.03	3.02	1.98	547
	—	760	—	420	—	420	—	2	6	11 000	19 300	1 730	4TR500Q	1-P	566	750	696	11.5	2	6	0.39	1.74	2.59	1.70	698
501.650	19.7500	673.100	26.5000	387.350	15.2500	400.050	15.7500	6.4	3.2	8 340	17 300	1 550	EE641198D/265/266D	1-P	538	650	628	9.5	6.4	3.2	0.31	2.15	3.20	2.10	386
	19.7500	711.200	28.0000	520.700	20.5000	520.700	20.5000	6.4	3.2	12 300	26 400	2 210	M274149D/110/110D	1-P	549	687	656	10.5	6.4	3.2	0.33	2.03	3.02	1.98	673
508.000	20.0000	716.000	28.1890	528.000	20.7874	528.000	20.7874	8	3.2	12 700	26 300	2 200	4TR508	1-P	549	689	664	9.5	8	3.2	0.35	1.95	2.90	1.91	679

[Notes] 1) While metric series bearings have minus tolerances for bore and OD, inch series have plus tolerances. Refer to page 194 for details of applicable tolerance standards.

2) SP indicates the specially chamfered form.

Four-row tapered roller bearings

TQO type

d (508.000) ~ 558.750 mm

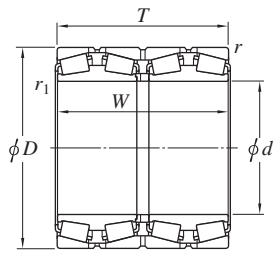

Design 1

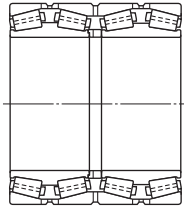

Design 1-P

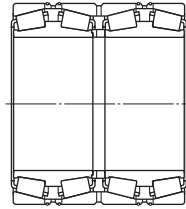

Design 2

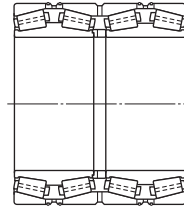

Design 2-P

For oil mist lubrication

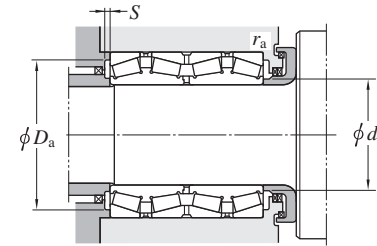

Boundary dimensions								Basic load ratings (kN)		Fatigue load limit	Bearing No. 1)	Design	Mounting dimensions (mm)						Constant e	Axial load factors			(Refer.) Mass (kg)
d mm	D mm	T mm	W mm	r min.	$r_1^{2)}$ min.	C_r	C_{0r}	(kN) C_u	d_a max.	D_a max.			S min.	r_a max.	r_b max.	Y_2	Y_3	Y_0					
508.000	762.000	463.550	463.550	6.4	6.4	11 400	19 900	1 780	EE531201D/300/301XD	1-P	564	738	696	11.5	6.4	6.4	0.38	1.78	2.65	1.74	736		
509.948	654.924	379.000	377.000	6.4	1.6	7 260	16 700	1 460	4TR510A	1-P	534	632	612	7	6.4	1.6	0.41	1.64	2.44	1.60	315		
510	655	379	377	5	2.5	8 190	18 600	1 650	4TR510L	1-P	540	633	613	9	4	2.5	0.26	2.55	3.80	2.50	320		
	730	520	520	5	6	13 100	27 300	2 280	4TR510Q	1-P	559	708	674	13	4	6	0.33	2.03	3.02	1.98	728		
514.350	673.100	422.275	422.275	6.4	3.2	9 000	20 100	1 730	4TR514A	1	545	650	630	11	6.4	3.2	0.33	2.03	3.02	1.98	392		
	673.100	422.275	422.275	6.4	3.2	8 930	20 300	1 760	LM274449D/410/410D	1-P	547	650	630	9	6.4	3.2	0.33	2.03	3.02	1.98	399		
519.113	736.600	536.575	536.575	6.4	3.2	13 300	27 200	2 270	M275349D/310/310D	1-P	562	712	681	10.5	6.4	3.2	0.33	2.03	3.02	1.98	743		
520	735	535	535	5	2.5	13 300	27 200	2 270	4TR520	1-P	564	713	681	11.5	4	2.5	0.33	2.03	3.02	1.98	726		
520.700	711.200	400.050	400.050	6.4	3.2	8 750	17 500	1 550	LM275349D/10/10D	1-P	562	687	663	7	6.4	3.2	0.33	2.03	3.02	1.98	438		
530	730	540	535	5	SP	12 700	27 900	2 310	4TR530-1	1-P	570	708	677	9	4	3	0.34	1.96	2.92	1.92	686		
	730	540	535	4	SP	11 800	25 000	2 090	4TR530-2	1	567	712	677	6	3	3	0.34	1.96	2.92	1.92	669		
	750	480	480	6	6	12 400	24 700	2 110	4TR530B	1-P	584	722	695	11.5	5	5	0.32	2.12	3.15	2.07	680		
	750	480	480	5	2	12 100	24 100	2 040	4TR530C	1	579	728	695	9.5	4	2	0.32	2.12	3.15	2.07	673		
535	750	560	560	5	6	13 900	29 400	2 420	4TR535	1-P	579	728	695	10.5	4	5	0.33	2.02	3.01	1.98	761		
	760	560	560	6	6	14 100	28 800	2 380	372/535	1-P	587	732	703	10	5	5	0.33	2.02	3.01	1.98	815		
536.575	761.873	558.800	558.800	6.4	3.2	14 100	28 800	2 380	M276449D/410/410D	1-P	578	738	700	9	6.4	3.2	0.33	2.03	3.02	1.98	820		
540	690	400	400	5	2.5	8 420	19 800	1 700	4TR540	1-P	566	668	648	10.5	4	2	0.40	1.68	2.50	1.64	369		
	760	560	560	5	6	14 200	30 600	2 500	4TR540A	1-P	587	738	704	10.5	4	6	0.33	2.03	3.02	1.98	808		
550	685	350	350	4	1.5	6 630	16 100	1 390	4TR550C	1	579	667	647	8	3	1.5	0.29	2.32	3.45	2.26	287		
555.625	698.500	349.250	349.250	6.4	3.2	7 160	17 000	1 470	4TR555	1-P	586	675	655	9.5	6.4	3.2	0.33	2.03	3.02	1.98	312		
558.750	965.300	495.300	495.300	7.5	7.5	15 700	25 700	2 200	4TR559B	1-P	685	934	855	11.5	7.5	7.5	0.33	2.03	3.02	1.98	1 570		

[Notes] 1) While metric series bearings have minus tolerances for bore and OD, inch series have plus tolerances. Refer to page 194 for details of applicable tolerance standards.

2) SP indicates the specially chamfered form.

Four-row tapered roller bearings

TQO type

d 558.800 ~ 609.600 mm

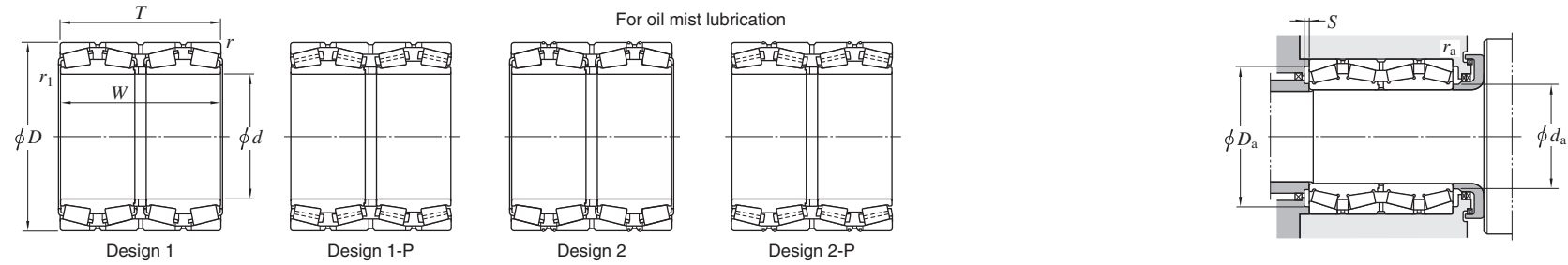

Boundary dimensions								Basic load ratings (kN)		Fatigue load limit (kN)	Design	Mounting dimensions (mm)	Constant	Axial load factors			(Refer.) Mass (kg)								
d mm	D mm	T mm	W mm	r min.	r_1 min.	C_r	C_{0r}	C_u	Bearing No. 1)	d_a max.				D_a max.	S min.	r_a max.		r_b max.	e	Y_2	Y_3	Y_0			
558.800	22.0000	736.600	29.0000	322.263	12.6875	322.263	12.6875	6.4	3.2	7 430	16 100	1 430	EE843221D/290/291D 4TR559J 4TR559N 4TR559 4TR559A LM277149DA/110/110D	1-P	607	712	692	9.5	6.4	3.2	0.34	1.97	2.93	1.93	371
	22.0000	736.600	29.0000	409.575	16.1250	409.575	16.1250	6.4	3.2	8 670	18 800	1 630		1	598	712	691	10	6.4	3.2	0.35	1.95	2.90	1.91	463
	22.0000	736.600	29.0000	409.575	16.1250	409.575	16.1250	6.4	3.2	9 600	21 500	1 850		1-P	594	712	689	10.5	6.4	3.2	0.35	1.95	2.90	1.91	477
	22.0000	736.600	29.0000	430.000	16.9291	430.000	16.9291	6.4	3.2	10 100	22 200	1 880		1	593	712	690	12	6.4	3.2	0.35	1.95	2.90	1.91	497
	22.0000	736.600	29.0000	450.000	17.7165	450.000	17.7165	4	3	10 300	23 100	1 950		1-P	594	717	692	9	4	3	0.35	1.95	2.90	1.91	525
	22.0000	736.600	29.0000	457.200	18.0000	455.612	17.9375	6.4	3.2	11 200	25 500	2 120		1-P	595	712	692	11.5	6.4	3.2	0.33	2.03	3.02	1.98	521
560	—	805	—	590	—	590	—	6	6	16 200	33 700	2 720	372/560 4TR560	1-P	614	777	744	10.5	5	5	0.33	2.03	3.02	1.98	1 000
	—	920	—	620	—	620	—	7.5	7.5	19 200	32 800	2 660		1-P	643	884	823	12	6	6	0.40	1.68	2.50	1.64	1 650
570	—	780	—	515	—	515	—	5	2.5	12 600	27 400	2 240	4TR570A 4TR570C	1-P	618	758	726	10	4	2	0.42	1.61	2.39	1.57	737
	—	810	—	590	—	590	—	5	2	16 300	35 000	2 790		1-P	625	788	751	14	4	2	0.33	2.03	3.02	1.98	1 000
571.500	22.5000	812.800	32.0000	593.725	23.3750	593.725	23.3750	6.4	3.2	16 300	35 000	2 790	4TR572 M278749D/710/710D	2-P	625	789	751	13	6.4	3.2	0.33	2.03	3.02	1.98	1 020
	22.5000	812.800	32.0000	593.725	23.3750	593.725	23.3750	6.4	3.2	16 300	35 000	2 790		1-P	625	789	751	14	6.4	3.2	0.33	2.03	3.02	1.98	1 020
580	—	770	—	510	—	510	—	4	1.5	12 800	29 600	2 410	4TR580	1-P	618	752	723	12	3	1.5	0.33	2.03	3.02	1.98	671
584.200	23.0000	730.250	28.7500	349.250	13.7500	342.900	13.5000	3.2	1.6	7 000	17 300	1 460	4TR584 LM778549D/510/510D	1-P	613	712	692	6.5	3.2	1.6	0.43	1.57	2.34	1.53	326
	23.0000	762.000	30.0000	401.638	15.8125	396.875	15.6250	6.4	3.2	9 190	20 800	1 770		1-P	617	738	715	8.5	6.4	3.2	0.47	1.43	2.12	1.40	468
585.788	23.0625	771.525	30.3750	479.425	18.8750	479.425	18.8750	6.4	3.2	11 400	25 600	2 120	LM278849D/810/810D	1-P	622	747	725	11	6.4	3.2	0.33	2.03	3.02	1.98	599
595.312	23.4375	844.550	33.2500	615.950	24.2500	615.950	24.2500	6.4	3.2	17 000	36 900	2 910	M280049D/010/010D	1-P	651	820	780	8	6.4	3.2	0.33	2.03	3.02	1.98	1 130
600	—	855	—	620	—	620	—	5	6	17 600	37 900	2 970	4TR600B	1-P	658	833	792	13	4	5	0.33	2.03	3.02	1.98	1 160
603.250	23.7500	857.250	33.7500	622.300	24.5000	622.300	24.5000	6.4	3.2	18 100	38 500	3 020	M280249D/210/210XD	1-P	652	833	788	12	6.4	3.2	0.33	2.03	3.02	1.98	1 170
609.600	24.0000	787.400	31.0000	361.950	14.2500	361.950	14.2500	6.4	3.2	8 520	19 900	1 680	4TR610A EE649241D/310/311D 4TR609 4TR610	2-P	650	763	739	13	6.4	3.2	0.37	1.82	2.70	1.78	455
	24.0000	787.400	31.0000	361.950	14.2500	361.950	14.2500	6.4	3.2	8 520	19 900	1 680		1-P	650	763	739	13	6.4	3.2	0.37	1.82	2.70	1.78	459
	24.0000	813.562	32.0300	479.425	18.8750	479.425	18.8750	6.4	3.2	11 700	27 100	2 210		1-P	657	789	759	9	6.4	3.2	0.33	2.03	3.02	1.98	710
	24.0000	817.400	32.1811	361.950	14.2500	361.950	14.2500	6.4	3.2	9 120	18 200	1 590		1-P	660	793	766	7	6.4	3.2	0.33	2.03	3.02	1.98	531

[Note] 1) While metric series bearings have minus tolerances for bore and OD, inch series have plus tolerances. Refer to page 194 for details of applicable tolerance standards.

Four-row tapered roller bearings

TQO type

d 620 ~ 685.800 mm

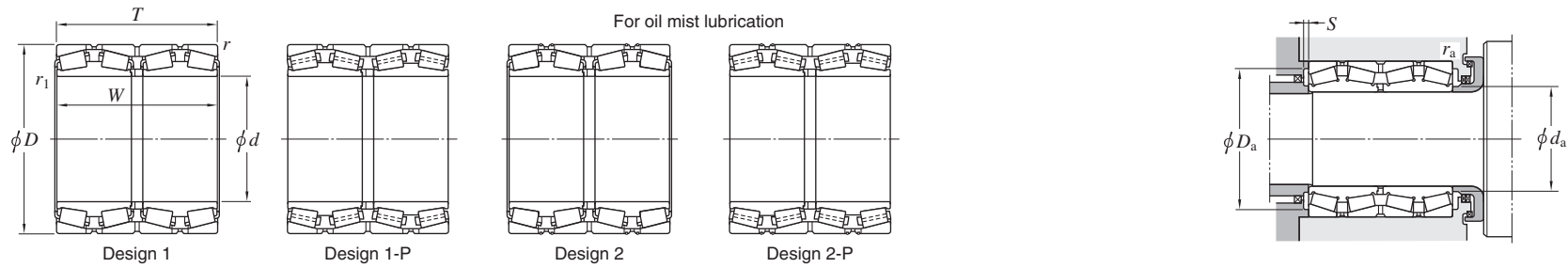

Boundary dimensions										Basic load ratings (kN)		Fatigue load limit	Bearing No. ¹⁾	Design	Mounting dimensions (mm)						Constant	Axial load factors			(Refer.) Mass (kg)	
d mm	D mm	T mm	W mm	r min.	r_1 min.	C_r	C_{0r}	C_u			d_a max.	D_a max.			S min.	r_a max.	r_b max.	e	Y_2	Y_3	Y_0					
620	—	800	—	365	—	365	—	5	2.5	9 510	21 000	1 790		4TR620	1-P	661	778	756	14	4	2	0.32	2.12	3.15	2.07	474
630	—	920	—	457.15	—	457.15	—	6	3	14 400	26 200	2 230		4TR630B	1-P	698	892	846	11.5	5	2.5	0.33	2.03	3.02	1.98	1 050
635	—	900	—	660	—	660	—	6	6	18 700	39 700	3 080		4TR635	1-P	690	872	832	7	5	5	0.33	2.03	3.02	1.98	1 350
635.000	25.0000	901.700	35.5000	654.050	25.7500	654.050	25.7500	6.4	3.2	18 700	39 700	3 080		M281049D/010/010XD	1-P	691	877	833	7	6.4	3.2	0.33	2.03	3.02	1.98	1 360
646.112	25.4375	857.250	33.7500	542.925	21.3750	542.925	21.3750	6.4	3.2	14 300	34 100	2 680		LM281049D/10/10D	1-P	690	833	801	13	6.4	3.2	0.33	2.03	3.02	1.98	881
649.924	25.5876	914.898	36.0196	674.000	26.5354	672.000	26.4567	6	3.6	20 000	43 800	3 360		M281349D/10/10D	1-P	703	891	844	12	6	3.6	0.33	2.03	3.02	1.98	1 430
650	—	1 030	—	558.5	—	558.5	—	12	7.5	20 000	36 200	2 900		47T130103	1-P	749	986	925	10.5	10	6	0.32	2.12	3.15	2.07	1 850
657.225	25.8750	933.450	36.7500	676.275	26.6250	676.275	26.6250	6.4	3.3	21 600	46 000	3 510		M281649D/610/610D	1-P	713	909	864	9.5	6.4	3.3	0.33	2.03	3.02	1.98	1 530
660	—	855	—	320	—	320	—	4	5	7 930	18 000	1 510		4TR660D	1-P	705	837	799	11.5	3	4	0.47	1.43	2.12	1.40	481
660.400	26.0000	812.800	32.0000	365.125	14.3750	365.125	14.3750	6.4	3.2	8 600	21 100	1 750		4TR660C	2-P	691	789	775	8	6.4	3.2	0.33	2.03	3.02	1.98	402
	26.0000	812.800	32.0000	365.125	14.3750	365.125	14.3750	6.4	3.2	8 600	21 100	1 750		L281149D/110/110D	1-P	691	789	775	8	6.4	3.2	0.33	2.03	3.02	1.98	405
670	—	960	—	700	—	700	—	7.5	5	22 300	48 100	3 630		4TR670	1-P	732	924	884	13	6	4	0.33	2.03	3.02	1.98	1 710
676	—	910	—	620	—	620	—	5	2	18 200	43 300	3 310		4TR676	1-P	724	888	849	13.5	4	2	0.33	2.03	3.02	1.98	1 180
679.450	26.7500	901.700	35.5000	552.450	21.7500	552.450	21.7500	6.4	3.2	16 000	36 100	2 820		LM281849D/810/810D	1-P	724	877	847	11.5	6.4	3.2	0.33	2.03	3.02	1.98	973
680	—	870	—	460	—	460	—	4	2.5	11 400	27 400	2 190		47T13608746	1-P	710	852	820	9	3	2.5	0.50	1.34	2.00	1.32	677
680.000	26.7717	970.000	38.1890	740.000	29.1339	740.000	29.1339	6.4	3.2	23 600	52 800	3 930		4TR680B	1-P	743	946	896	9	6.4	3.2	0.33	2.03	3.02	1.98	1 790
680	—	1 020	—	555	—	555	—	6	3	19 200	36 700	2 910		4TR680C	1-P	771	992	934	14.5	5	2.5	0.32	2.12	3.15	2.07	1 650
685.800	27.0000	876.300	34.5000	355.600	14.0000	352.425	13.8750	6.4	3.2	9 280	23 100	1 880		4TR686A	1-P	734	852	824	11	6.4	3.2	0.42	1.62	2.42	1.59	554
	27.0000	876.300	34.5000	355.600	14.0000	352.425	13.8750	6.4	3.2	9 280	23 100	1 880		4TR686D	2-P	734	852	823	11	6.4	3.2	0.42	1.62	2.42	1.59	555

[Note] 1) While metric series bearings have minus tolerances for bore and OD, inch series have plus tolerances. Refer to page 194 for details of applicable tolerance standards.

Four-row tapered roller bearings

TQO type

d 708.025 ~ (863.600) mm

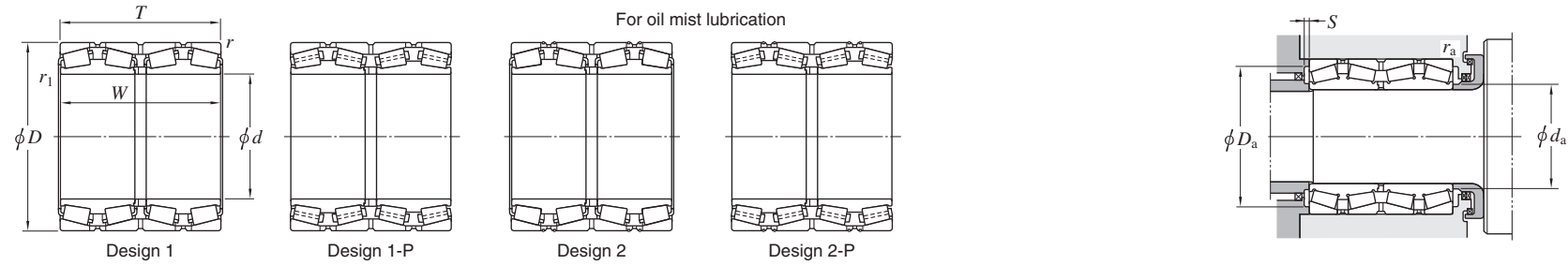

Boundary dimensions								Basic load ratings (kN)		Fatigue load limit	Bearing No. 1)	Design	Mounting dimensions (mm)						Constant e	Axial load factors			(Refer.) Mass (kg)
d mm	D mm	T mm	W mm	r min.	r_1 2) min.	C_r	C_{0r}	C_u	d_a max.	D_a max.			S min.	r_a max.	r_b max.	Y_2	Y_3	Y_0					
708.025	930.275	565.150	565.150	6.4	3.2	17 200	40 300	3 100	4TR708B	1-P	753	906	878	11	6.4	3.2	0.33	2.03	3.02	1.98	1 050		
710.000	900.000	410.000	410.000	6	3	11 500	27 300	2 230	4TR710	1-P	750	877	853	11.5	6	2.5	0.35	1.95	2.90	1.91	636		
711.200	914.400	317.500	317.500	6.4	6.4	8 550	18 800	1 580	4TR711	1-P	774	890	868	11.5	6.4	6.4	0.38	1.78	2.65	1.74	538		
	914.400	355.600	355.600	6.4	3.2	9 840	21 200	1 780	47T1429136	1-P	753	890	860	10.5	6.4	3.2	0.38	1.78	2.65	1.74	598		
714.375	1 016.000	704.850	704.850	6.4	3.2	24 400	52 200	3 880	M383240D/210/210D	1-P	776	992	940	14.5	6.4	3.2	0.35	1.92	2.86	1.88	1 900		
717.550	946.150	565.150	565.150	6.4	3.2	17 000	39 500	3 030	LM282847D/810/810D	1-P	764	922	890	12.5	6.4	3.2	0.33	2.03	3.02	1.98	1 090		
730	1 035	755	755	5	2.5	24 600	54 300	4 000	4TR730	1-P	795	1 013	955	11	4	2	0.33	2.03	3.02	1.98	2 080		
730.250	1 035.050	755.650	755.650	6.4	3.2	24 600	54 300	4 000	M283449D/410/410D	1-P	795	1 011	955	11	6.4	3.2	0.33	2.03	3.02	1.98	2 080		
749.300	990.600	605.000	605.000	6.4	3.2	19 600	47 700	3 560	LM283649D/610/610D	1-P	801	966	929	13	6.4	3.2	0.32	2.12	3.15	2.07	1 320		
750.000	950.000	410.000	410.000	4	2.5	12 100	29 000	2 320	4TR750	1-P	791	929	900	11.5	4	2	0.40	1.68	2.50	1.68	705		
750	1 130	690	690	7.5	7.5	24 400	45 800	3 450	4TR750A	1-P	821	1 094	1 023	13	6	6	0.46	1.47	2.19	1.44	2 500		
760	1 080	630	630	6	3	22 300	46 300	3 470	4TR760	1-P	829	1 052	999	17.5	5	2.5	0.40	1.68	2.50	1.64	1 900		
762.000	1 066.800	736.600	736.600	12.7	SP	24 900	55 900	4 070	4TR762	1-P	829	1 030	986	6	12.7	6.4	0.33	2.03	3.02	1.98	2 070		
	1 079.500	787.400	787.400	12.7	4.8	27 900	62 700	4 530	M284249D/210/210XD	1-P	831	1 043	998	11	12.7	4.8	0.33	2.03	3.02	1.98	2 360		
785.000	1 040.000	560.000	560.000	7.5	5	19 200	44 400	3 350	4TR785B	1-P	846	1 009	978	13	7.5	5	0.26	2.55	3.80	2.50	1 340		
800	1 120	820	820	7.5	6	30 200	70 200	4 970	4TR800	1-P	869	1 084	1 038	13.5	6	5	0.33	2.03	3.02	1.98	2 590		
825.500	1 168.400	844.550	844.550	12.7	4.8	32 500	72 300	5 110	M285848D/10/10D	1-P	897	1 132	1 083	15.5	12.7	4.8	0.33	2.03	3.02	1.98	2 980		
840	1 170	840	840	7.5	7.5	32 100	74 600	5 220	4TR840	1-P	911	1 134	1 089	16	6	6	0.33	2.03	3.02	1.98	2 880		
863.600	1 130.300	669.925	669.925	12.7	4.8	23 900	59 600	4 250	LM286249D/210/210D	1-P	920	1 093	1 063	15	12.7	4.8	0.32	2.08	3.10	2.04	1 840		

[Notes] 1) While metric series bearings have minus tolerances for bore and OD, inch series have plus tolerances. Refer to page 194 for details of applicable tolerance standards.

2) SP indicates the specially chamfered form.

Four-row tapered roller bearings

TQO type

d (863.600) ~ 1 020 mm

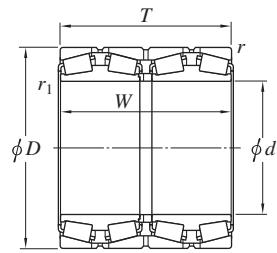

Design 1

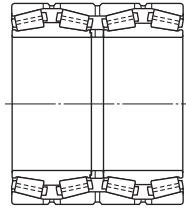

Design 1-P

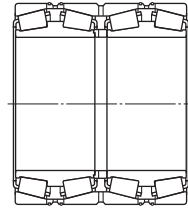

Design 2

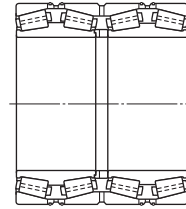

Design 2-P

For oil mist lubrication

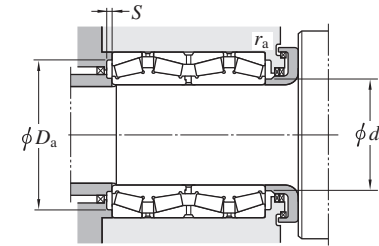

Boundary dimensions										Basic load ratings (kN)		Fatigue load limit (kN)	Bearing No. ¹⁾	Design	Mounting dimensions (mm)						Constant e	Axial load factors			(Refer.) Mass (kg)
d mm	D mm	T mm	W mm	r min.	r_1 min.	C_r	C_{0r}	C_u		d_a max.	D_a max.	S min.			r_a max.	r_b max.	Y_2	Y_3	Y_0						
863.600	34.0000	1 219.200	48.0000	889.000	35.0000	876.300	34.5000	12.7	4.8	35 700	84 600	5 820	EE547341D/480/481D	1-P	947	1 182	1 130	9	12.7	4.8	0.33	2.03	3.02	1.98	3 390
938.213	36.9375	1 270.000	50.0000	825.500	32.5000	825.500	32.5000	12.7	4.8	33 500	79 800	5 480	LM287649D/610/610D	1-P	1 007	1 233	1 187	17.5	12.7	4.8	0.33	2.03	3.02	1.98	3 130
939.800	37.0000	1 333.500	52.5000	952.500	37.5000	952.500	37.5000	12.7	4.8	42 000	95 400	6 420	LM287849D/810/810D	1-P	1 022	1 297	1 235	15.5	12.7	4.8	0.33	2.03	3.02	1.98	4 380
1 020	—	1 570	—	900	—	900	—	7.5	7.5	45 800	98 800	6 540	4TR1020	1-P	1 172	1 534	1 413	21	6	6	0.33	2.03	3.02	1.98	6 890

[Note] 1) While metric series bearings have minus tolerances for bore and OD, inch series have plus tolerances. Refer to page 194 for details of applicable tolerance standards.

Four-row tapered roller bearings

45D type

d 346.075 ~ 509.948 mm

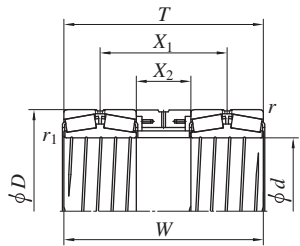

Design 1

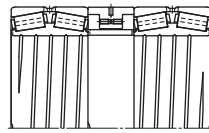

Design 1-P

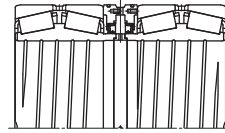

Design 2

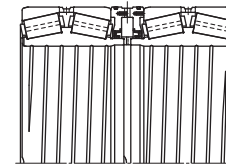

Design 2-P

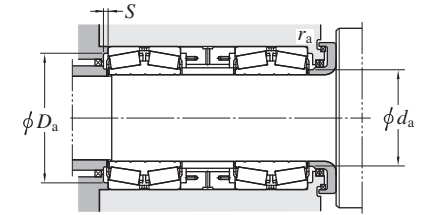

Boundary dimensions											Basic load ratings (kN)		Fatigue load limit (kN) <i>C_u</i>	Bearing No. ¹⁾	Design	Mounting dimensions (mm)						Constant <i>e</i>	Axial load factors			(Refer.) Mass (kg)
<i>d</i> mm	<i>D</i> mm	<i>T</i> mm	<i>W</i> mm	<i>X</i> ₁ mm	<i>X</i> ₂ mm	<i>r</i> ²⁾ min.	<i>r</i> ₁ ²⁾ min.	<i>C_r</i>	<i>C</i> _{0r}	<i>d</i> _a max.	<i>D</i> _a max.	<i>S</i> min.				<i>r</i> _a max.	<i>r</i> _b max.	<i>e</i>	<i>Y</i> ₂	<i>Y</i> ₃	<i>Y</i> ₀					
346.075	488.950	417.000	417.000	242.375	67.750	3.2	3.2	5 790	11 600	1 110	45D694942	2	378	478	449	8	3.2	3.2	0.33	2.02	3	1.97	240			
360	450	350	350	225	100	2	1.5	3 340	7 460	721	45D724535	1	380	440	425	5.5	2	1.5	0.29	2.32	3.45	2.26	109			
380	530	540	540	340	140	4	3	6 900	13 800	1 310	45D765354	1-P	412	512	488	11	3	2.5	0.26	2.55	3.8	2.5	323			
384.175	546.100	514.350	514.350	320.675	127.000	6.4	3.2	8 180	16 900	1 550	45D775551	1-P	418	529	502	10.5	6.4	3.2	0.33	2.03	3.02	1.98	386			
385.762	514.350	317.500	317.500	164.500	11.500	3.2	3.2	5 480	11 000	1 060	45D775132	1	415	503	483	9	3.2	3.2	0.26	2.55	3.8	2.5	180			
400	530	370	370	202	34	3	1	6 150	12 900	1 200	45D805337	1	428	516	497	11.5	2.5	1	0.26	2.55	3.8	2.5	213			
406.400	562.000	381.000	381.000	196.924	12.700	6.4	3.2	7 510	15 000	1 390	45D815638	1	439	545	524	9.5	6.4	3.2	0.33	2.03	3.02	1.98	286			
409.575	540.000	410.000	410.000	235.000	60.000	3	2	6 300	14 000	1 300	45D825441	1	439	528	507	11	3	2	0.26	2.55	3.8	2.5	255			
	546.100	400.000	400.000	238.075	76.150	6.4	1.6	5 710	11 500	1 080	45D825540	1-P	432	529	511	8.5	6.4	1.6	0.42	1.62	2.42	1.59	228			
430	575	500	500	295	90	SP	2	7 080	14 900	1 370	45D865850	2	460	575	539	4.5	5	2	0.26	2.55	3.8	2.5	350			
431.800	571.500	400.000	400.000	238.075	76.150	6.4	3	5 990	12 500	1 150	45D865740	1-P	460	554	536	10.5	6.4	3	0.36	1.87	2.79	1.83	281			
460	586	500	500	325	150	3	3	6 650	15 500	1 390	45D925950	1	487	572	555	11.5	2.5	2.5	0.26	2.55	3.8	2.5	319			
	680	390	390	225	60	5	1.5	7 540	13 700	1 270	45D926839	1	518	658	619	11.5	4	1.5	0.36	1.87	2.79	1.83	429			
480	700	470	470	267	64	5	1.5	10 100	18 800	1 680	45D967047	2	531	678	644	11	4	1.5	0.35	1.95	2.9	1.91	599			
482	632	520	520	320	120	1.5	1.5	8 540	18 800	1 670	45D966352A	1-P	510	623.5	593	7	2	1.5	0.26	2.55	3.8	2.5	416			
482.600	615.950	425.000	425.000	237.000	49.000	4	1.5	7 290	16 700	1 480	45D976243	1	510	601	585	11	4	1.5	0.26	2.55	3.8	2.5	292			
	615.950	488.750	488.750	300.750	112.750	4	SP	7 290	16 700	1 480	45D976249	2	500	601	585	11	4	2	0.26	2.55	3.8	2.5	329			
	615.950	500.000	500.000	314.250	182.500	6.4	6.4	6 060	13 400	1 220	45D976250A	1-P	512	599	583	6.5	6.4	6.4	0.44	1.54	2.3	1.51	358			
486	654.924	500	500	315.5	131	3	3	8 200	17 000	1 530	45D976550-1	1-P	523	640	610	11	2.5	2.5	0.28	2.43	3.61	2.37	455			
509.948	654.924	500.000	500.000	310.000	120.000	3	1.5	8 090	19 000	1 670	4TR510C	1-P	539	642	617	10	3	1.5	0.28	2.43	3.61	2.37	405			

[Notes] 1) While metric series bearings have minus tolerances for bore and OD, inch series have plus tolerances. Refer to page 194 for details of applicable tolerance standards.

2) SP indicates the specially chamfered form.

Four-row tapered roller bearings

45D type

d 510 ~ 685.800 mm

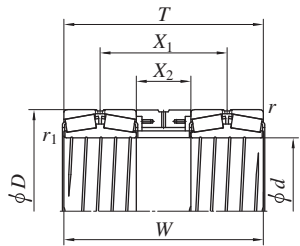

Design 1

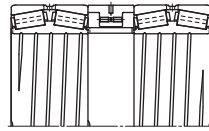

Design 1-P

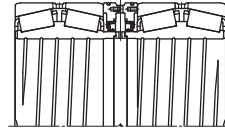

Design 2

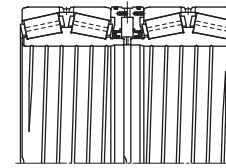

Design 2-P

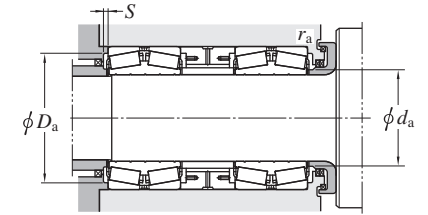

Boundary dimensions											Basic load ratings (kN)		Fatigue load limit (kN) C_u	Bearing No. ¹⁾	Design	Mounting dimensions (mm)					Constant e	Axial load factors			(Refer.) Mass (kg)
d mm	D mm	T mm	W mm	X_1 mm	X_2 mm	r ²⁾ min.	r_1 min.	C_r	C_{0r}	d_a max.	D_a max.	S min.				r_a ²⁾ max.	r_b max.	e	Y_2	Y_3		Y_0			
510	655	379	377	199.5	12	5	2	8 190	18 600	1 650	4TR510L-2	1-P	540	633	619	9	4	2	0.26	2.55	3.8	2.5	320		
558.800	736.600	514.000	514.000	293.337	72.674	6.4	3.2	11 200	25 500	2 120	4TR559P-1	1-P	595	719	693	11.5	6.4	3.2	0.33	2.03	3.02	1.98	576		
609.600	813.562	548.000	548.000	317.000	86.000	SP	6.4	12 700	28 500	2 320	4TR610D	2-P	653	792	764	11.5	SP	6.4	0.33	2.03	3.02	1.98	776		
685.800	876.300	580.000	580.000	340.000	100.000	6.4	3.2	13 800	34 900	2 740	4TR686J	1-P	730	859	829	14	6.4	3.2	0.26	2.55	3.8	2.5	875		

[Notes] 1) While metric series bearings have minus tolerances for bore and OD, inch series have plus tolerances. Refer to page 194 for details of applicable tolerance standards.

2) SP indicates the specially chamfered form.

Sealed type four-row tapered roller bearings

d 75 ~ 234.950 mm

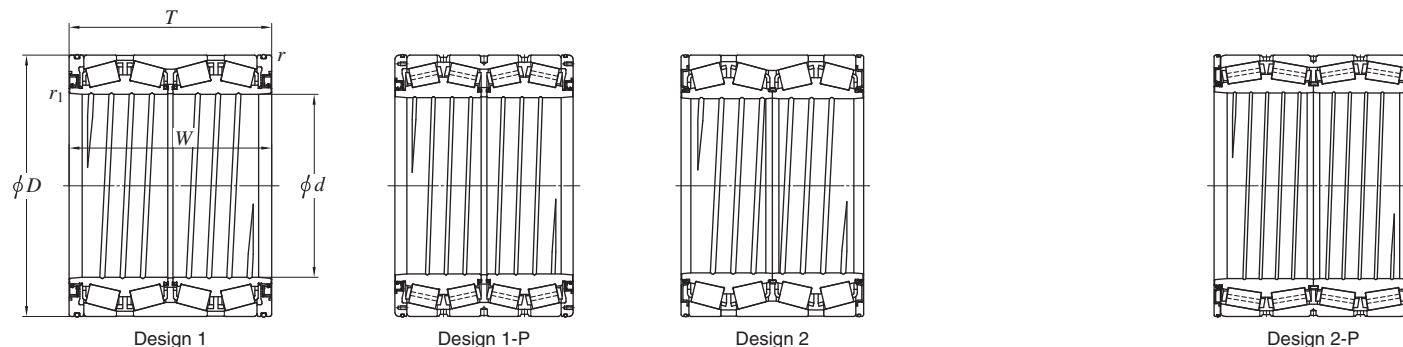

Boundary dimensions								Basic load ratings (kN)		Fatigue load limit (kN) C_u	Bearing No.	Design	Constant e	Axial load factors		(Refer.) Mass (kg)
d mm	D mm	T mm	W mm	$r^{1)}$ min.	$r_1^{1)}$ min.	C_r	C_{Or}	Y_2	Y_3							
75	—	120	—	150	—	150	—	2	1	533	764	1	0.33	2.03	3.02	6.4
	—	135	—	180	—	187	—	1.5	1.5	572	776	1	0.87	0.78	1.16	10.7
140	—	198	—	174	—	174	—	4	1	1 010	1 630	1	0.47	1.43	2.12	16.3
150	—	210	—	240	—	240	—	1.5	0.5	1 240	2 270	1	0.39	1.74	2.59	23.5
170	—	240	—	175	—	175	—	2.5	1.5	1 230	1 990	1	0.26	2.55	3.8	23.9
	—	250	—	230	—	230	—	2.5	1.5	1 710	2 860	1	0.26	2.55	3.8	37.7
190.500	7.5000	266.700	10.5000	188.913	7.4375	187.325	7.3750	3.2	1	1 320	2 270	1	0.46	1.47	2.19	27.6
195	—	270	—	250	—	250	—	2.5	1	1 780	3 550	1	0.4	1.68	2.5	43.6
200	—	300	—	300	—	300	—	4	1.6	2 840	4 900	1	0.26	2.55	3.8	73.5
203.200	8.0000	317.500	12.5000	266.700	10.5000	266.700	10.5000	5	1.6	2 590	4 010	1	0.4	1.68	2.5	76.8
206.375	8.1250	282.575	11.1250	190.500	7.5000	190.500	7.5000	3.2	1	1 370	2 240	1	0.51	1.33	1.97	33.5
	8.1250	282.575	11.1250	240.000	9.4488	210.000	8.2677	3	1	1 820	3 380	1	0.43	1.57	2.34	39.6
215.900	8.5000	288.925	11.3750	177.800	7.0000	177.800	7.0000	3.2	1	1 320	2 350	1	0.4	1.68	2.5	30.6
220	—	295	—	315	—	315	—	SP	SP	1 930	3 910	1	0.4	1.68	2.5	55.8
	—	320	—	290	—	290	—	3	2	2 750	4 700	1	0.39	1.74	2.59	73.9
	—	330	—	260	—	260	—	5	2.5	2 640	4 220	1	0.4	1.68	2.5	79.5
220.663	8.6875	314.325	12.3750	239.713	9.4375	239.713	9.4375	3.2	3	2 100	3 410	1	0.33	2.03	3.02	51.9
	8.6875	314.325	12.3750	330.000	12.9921	330.000	12.9921	3.2	3	2 960	5 650	1	0.26	2.55	3.8	79.2
225	—	320	—	230	—	230	—	3	1.5	2 040	3 350	1	0.47	1.43	2.12	56.9
228.600	9.0000	311.150	12.2500	200.025	7.8750	200.025	7.8750	3.2	SP	1 670	2 850	1	0.4	1.68	2.5	41.3
234.950	9.2500	327.025	12.8750	196.850	7.7500	196.850	7.7500	3.2	1	1 860	3 310	2	0.4	1.68	2.5	48.1

[Note] 1) SP indicates the specially chamfered form.

Sealed type four-row tapered roller bearings

d 240 ~ 279.578 mm

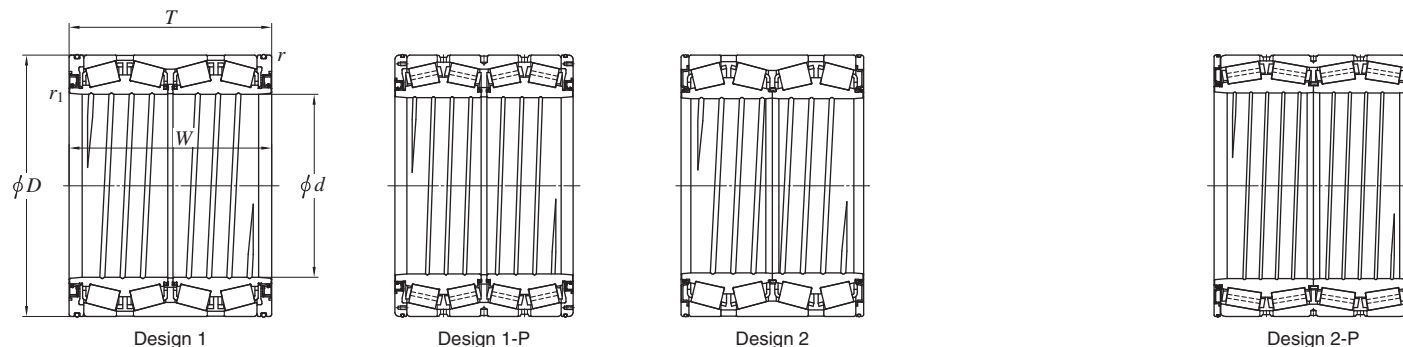

Boundary dimensions								Basic load ratings (kN)		Fatigue load limit (kN) C_u	Bearing No.	Design	Constant e	Axial load factors		(Refer.) Mass (kg)			
d mm	D mm	T mm	W mm	r min.	r_1 ¹⁾ min.	C_r	C_{0r}	Y_2	Y_3										
240	—	320	—	294	—	294	—	4	1	2 350	4 760	—	507	47TS483229-1	1	0.33	2.03	3.02	63.6
	—	338	—	248	—	248	—	3	1.5	2 370	4 120	—	442	47TS483425B	1	0.47	1.43	2.12	66
	—	338	—	290	—	290	—	3	1	2 960	5 360	—	580	47TS483429	1	0.39	1.74	2.59	78
	—	338	—	320	—	320	—	3	1	3 040	5 890	—	625	47TS483432	1	0.28	2.43	3.61	87.3
	—	338	—	340	—	340	—	3	1	3 070	5 930	—	620	47TS483434A	1	0.4	1.68	2.5	88
241.478	9.5070	349.148	13.7460	228.600	9.0000	228.600	9.0000	3.2	SP	2 510	4 110	—	450	47TS483523A	2	0.35	1.91	2.84	67.5
244.475	9.6250	327.025	12.8750	193.675	7.6250	193.675	7.6250	5	1.5	1 600	2 790	—	334	47TS493319	1	0.33	2.03	3.02	41.5
	9.6250	381.000	15.0000	304.800	12.0000	304.800	12.0000	5	1.6	3 400	5 240	—	558	47TS493830	1	0.47	1.43	2.12	124
245	—	345	—	310	—	310	—	3	1.5	3 150	6 020	—	631	47TS493531-2	1	0.4	1.68	2.5	89.9
250	—	365	—	270	—	270	—	3	1.5	2 830	4 730	—	513	47TS503727A-1	1	0.4	1.68	2.5	94.2
254.000	10.0000	358.775	14.1250	269.875	10.6250	269.875	10.6250	3.2	1.6	2 670	4 760	—	504	47TS513627A-1	1	0.55	1.24	1.84	82
	10.0000	358.775	14.1250	269.875	10.6250	269.875	10.6250	3.2	1.5	3 150	6 010	—	633	47TS513627B	2	0.4	1.68	2.5	85
260	—	365	—	340	—	340	—	3.5	1.6	3 510	6 530	—	674	47TS523734-5	1	0.4	1.68	2.5	110
	—	370	—	354	—	354	—	4	1.5	3 880	7 410	—	778	47TS523735	1	0.26	2.55	3.8	120
266.700	10.5000	355.600	14.0000	228.600	9.0000	230.188	9.0625	3.2	1.6	2 430	4 880	—	515	47TS533623B	2	0.36	1.87	2.79	60
275	—	385	—	340	—	340	—	3	1.5	3 720	7 400	—	372	47TS553934	1	0.4	1.68	2.5	121
276.225	10.8750	393.700	15.5000	269.875	10.6250	269.875	10.6250	3.2	1.6	2 940	5 040	—	535	47TS553927-4	1	0.47	1.43	2.12	100
	10.8750	393.700	15.5000	269.875	10.6250	269.875	10.6250	3.2	SP	3 460	6 510	—	678	47TS553927A	2	0.4	1.68	2.5	105
279.400	11.0000	393.700	15.5000	269.875	10.6250	269.875	10.6250	3.2	1.6	2 940	5 040	—	535	47TS563927	1	0.47	1.43	2.12	99.5
	11.0000	393.700	15.5000	269.875	10.6250	269.875	10.6250	3.2	SP	3 460	6 510	—	678	47TS563927B	2	0.4	1.68	2.5	101
	11.0000	393.700	15.5000	320.000	12.5984	320.000	12.5984	3.2	1.5	3 610	6 900	—	702	47TS563932-2	1	0.4	1.68	2.5	124
279.578	11.0070	380.898	14.9960	244.475	9.6250	244.475	9.6250	3.2	SP	2 830	5 360	—	559	47TS563824	2	0.4	1.68	2.5	78.3

[Note] 1) SP indicates the specially chamfered form.

Sealed type four-row tapered roller bearings

d 280 ~ 317.500 mm

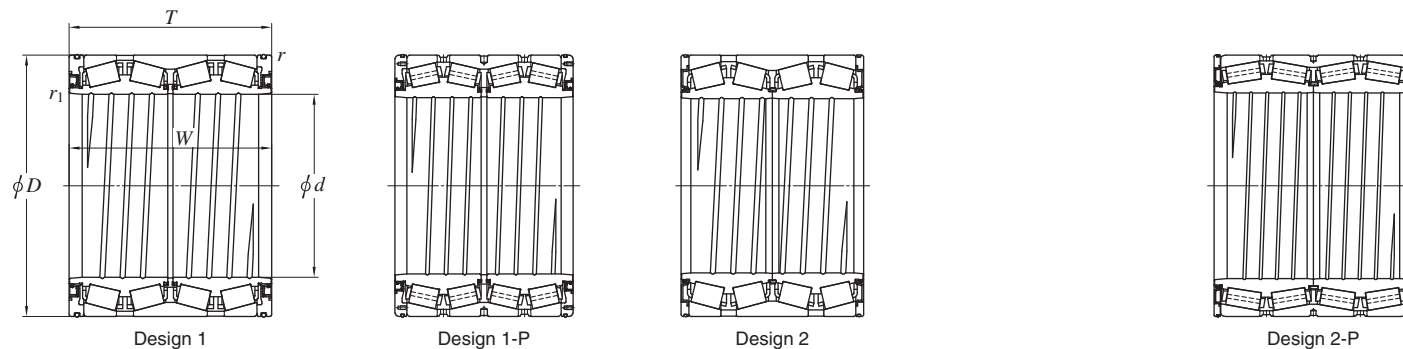

Boundary dimensions								Basic load ratings (kN)		Fatigue load limit (kN) C_u	Bearing No.	Design	Constant e	Axial load factors		(Refer.) Mass (kg)		
d mm	D mm	T mm	W mm	r min.	r_1 ¹⁾ min.	C_r	C_{Or}	Y_2	Y_3									
280	—	380	—	290	—	290	—	3.2	SP	3 400	6 940	706	47TS563829A	2	0.33	2.03	3.02	93.8
	—	395	—	290	—	290	—	3	2.5	3 310	5 940	614	47TS564029	1	0.4	1.68	2.5	110
	—	395	—	340	—	340	—	3	1.5	3 700	7 110	719	47TS564034A	1	0.4	1.68	2.5	130
	—	410	—	268	—	268	—	5.4	1.6	2 810	4 510	483	47TS564127	1	0.33	2.03	3.02	118
	—	412	—	340	—	340	—	4	2	4 200	7 220	751	47TS564134	1	0.28	2.43	3.61	154
	—	430	—	350	—	350	—	3.5	1.5	4 950	8 190	850	47TS564335	1	0.4	1.68	2.5	178
285	—	400	—	340	—	340	—	3	1.5	3 990	7 610	777	47TS574034	1	0.4	1.68	2.5	131
285.750	11.2500	380.898	14.9960	244.475	9.6250	244.475	9.6250	3.2	1	2 500	4 600	479	47TS573824A	1	0.43	1.57	2.34	73.2
290	—	400	—	346	—	346	—	4	1.5	3 830	7 860	792	47TS584035	1	0.4	1.68	2.5	128
	—	400	—	420	—	420	—	4	1.5	3 830	7 860	792	47TS584042C	1	0.4	1.68	2.5	155
	—	420	—	380	—	380	—	3	1.2	4 560	8 260	840	47TS584238	1	0.4	1.68	2.5	175
	—	450	—	415	—	415	—	4	1.5	5 610	9 460	938	47TS584542	1	0.47	1.43	2.12	238
300	—	400	—	254	—	254	—	4	5	2 770	5 300	546	47TS604025	1	0.28	2.43	3.61	84.6
	—	420	—	310	—	310	—	4	3.5	3 620	6 670	686	47TS604231	1	0.4	1.68	2.5	128
304.648	11.9940	438.048	17.2460	279.400	11.0000	280.990	11.0626	4	1.6	3 230	5 380	566	47TS614428B-10	1	0.47	1.44	2.15	135
	11.9940	438.048	17.2460	279.400	11.0000	279.400	11.0000	3.2	1.6	3 930	6 860	694	47TS614428C-1	2	0.4	1.68	2.5	135
304.800	12.0000	419.100	16.5000	269.875	10.6250	269.875	10.6250	6.4	2	3 120	5 420	573	47TS614227	1	0.33	2.03	3.02	100
	12.0000	501.650	19.7500	336.550	13.2500	296.550	11.6752	4	4	5 380	8 570	875	47TS615034	1-P	0.33	2.03	3.02	257
304.902	12.0040	412.648	16.2460	266.700	10.5000	266.700	10.5000	3.2	0.8	3 430	6 820	699	47TS614127D	2	0.39	1.74	2.59	99.5
310	—	430	—	310	—	310	—	3	1	3 770	6 880	706	47TS624331-4	1	0.4	1.68	2.5	131
	—	430	—	350	—	350	—	3.5	1.5	4 110	7 870	777	47TS624335A	1	0.4	1.68	2.5	148
	—	430	—	350	—	350	—	3.5	SP	4 110	7 870	777	47TS624335B-2	1	0.4	1.68	2.5	148
	—	457.098	—	390	—	390	—	4	1.5	5 260	9 500	951	47TS624639	1	0.32	2.12	3.15	220
317.500	12.5000	447.675	17.6250	367.000	14.4488	367.000	14.4488	4	1.6	4 610	8 500	839	47TS644537-1	1	0.4	1.68	2.5	176

[Note] 1) SP indicates the specially chamfered from.

Sealed type four-row tapered roller bearings

d 320 ~ 410 mm

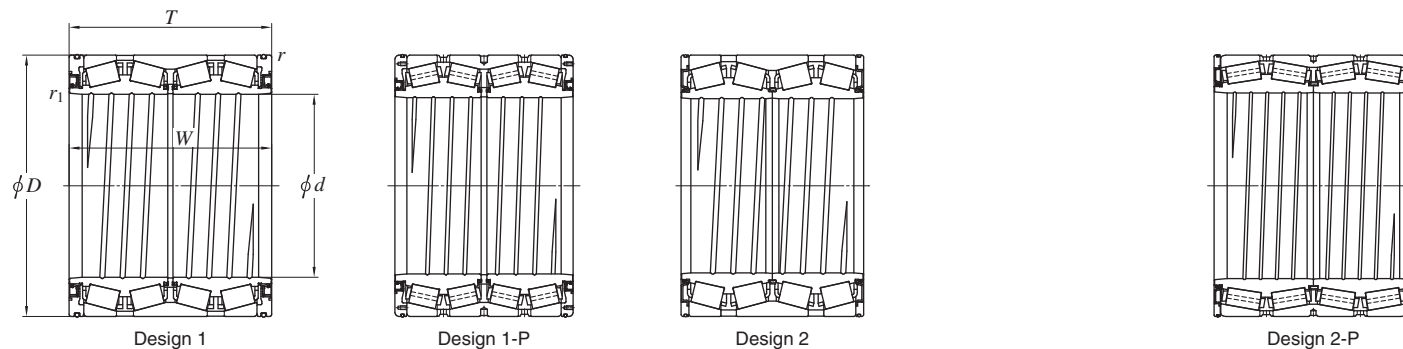

Boundary dimensions								Basic load ratings (kN)		Fatigue load limit (kN) C_u	Bearing No.	Design	Constant e	Axial load factors		(Refer.) Mass (kg)	
d mm	D mm	T mm	W mm	$r^{1)}$ min.	$r_1^{1)}$ min.	C_r	C_{0r}	Y_2	Y_3								
320	—	440	—	335	—	335	—	4	1	3 930	7 330	—	1	0.4	1.68	2.5	146
	—	480	—	360	—	360	—	4	1.5	5 290	8 800	736	1-P	0.47	1.43	2.12	220
	—	480	—	420	—	420	—	4	1.5	6 880	12 100	876	1-P	0.26	2.55	3.8	262
330.302	13.0040	438.023	17.2450	254.000	10.0000	247.650	9.7500	3.2	1.6	2 740	4 960	511	1	0.46	1.47	2.19	95.8
335.000	13.1890	460.000	18.1102	342.900	13.5000	342.900	13.5000	3.3	1.5	4 680	9 290	920	1	0.4	1.68	2.5	167
342.875	13.4990	488.900	19.2480	410.000	16.1417	410.000	16.1417	4	2	5 790	11 600	1 110	1	0.33	2.02	3	233
342.875	—	560	—	500	—	500	—	5	2.5	9 060	15 000	1 430	1-P	0.33	2.03	3.02	495
343.052	13.5060	457.098	17.9960	254.000	10.0000	254.000	10.0000	3.2	0.8	3 590	7 030	695	2	0.4	1.68	2.5	110
	13.5060	457.098	17.9960	299.000	11.7717	299.000	11.7717	3.2	SP	4 150	9 010	868	2	0.4	1.68	2.5	135
346.075	13.6250	488.950	19.2500	358.775	14.1250	358.775	14.1250	4	2	4 740	8 310	828	1	0.33	2.03	3.02	210
350	—	480	—	420	—	420	—	SP	1.5	4 630	9 100	894	1-P	0.4	1.68	2.5	217
355	—	490	—	316	—	316	—	2	1.6	4 430	7 920	782	1	0.33	2.03	3.02	169
355.600	14.0000	482.600	19.0000	269.875	10.6250	265.112	10.4375	3.2	1.5	3 350	6 090	608	1-P	0.47	1.43	2.12	134
360	—	480	—	375	—	375	—	3	1	5 150	10 600	1 020	1	0.4	1.68	2.5	181
374.650	14.7500	501.650	19.7500	260.350	10.2500	250.825	9.8750	3.2	1.6	3 900	7 470	739	2	0.33	2.03	3.02	136
380	—	580	—	370	—	370	—	3	SP	7 140	12 300	1 180	1-P	0.33	2.03	3.02	353
395	—	545	—	360	—	360	—	6	1.6	4 730	8 930	858	1	0.47	1.43	2.12	242
406.400	16.0000	546.100	21.5000	288.925	11.3750	288.925	11.3750	6.4	1	4 530	8 190	796	2-P	0.47	1.43	2.12	195
	16.0000	546.100	21.5000	330.000	12.9921	330.000	12.9921	4	1.5	5 380	10 500	997	2-P	0.43	1.57	2.34	204
	16.0000	546.100	21.5000	357.400	14.0709	357.400	14.0709	3.2	1.6	4 950	9 540	906	1	0.47	1.43	2.12	220
410	—	546	—	400	—	400	—	4	1.5	5 780	12 000	1 130	1	0.26	2.55	3.8	255

[Note] 1) SP indicates the specially chamfered from.

Sealed type four-row tapered roller bearings

d 415.925 ~ 482.600 mm

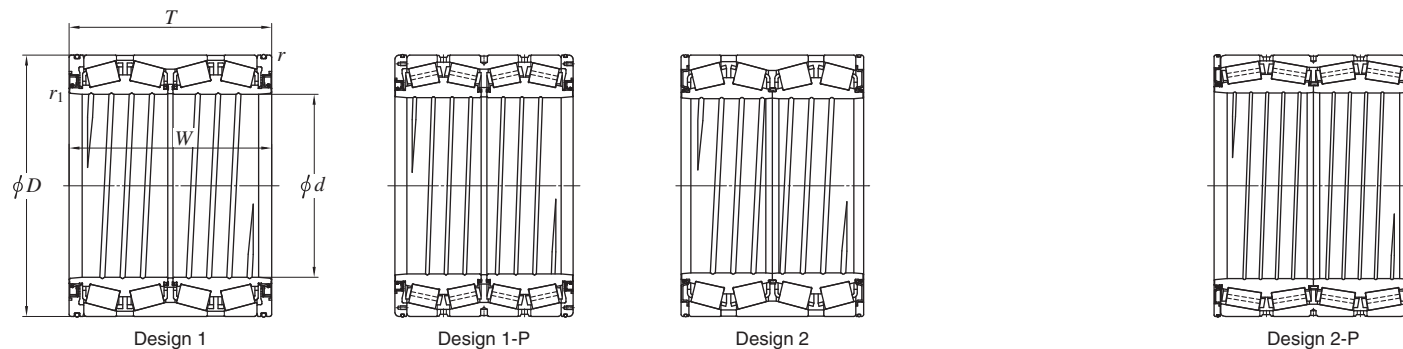

Boundary dimensions								Basic load ratings (kN)		Fatigue load limit (kN) C_u	Bearing No.	Design	Constant e	Axial load factors		(Refer.) Mass (kg)		
d mm	D mm	T mm	W mm	$r_1^{1)}$ min.	$r_1^{1)}$ min.	C_r	C_{0r}	Y_2	Y_3									
415.925	16.3750	590.550	23.2500	434.975	17.1250	434.975	17.1250	4	1.5	8 000	15 600		47TS835944A	2-P	0.4	1.68	2.5	377
420	—	560	—	437	—	437	—	4	3	7 020	14 900		47TS845644	1	0.26	2.55	3.8	298
	—	574	—	480	—	480	—	3	1.6	8 420	17 800		47TS845748	1-P	0.28	2.43	3.61	352
	—	620	—	395	—	320	—	SP	SP	6 460	11 600		47TS846240	1-P	0.47	1.43	2.12	390
430	—	575	—	380	—	380	—	3.2	SP	6 510	14 300		47TS865838A	2-P	0.26	2.55	3.8	276
431.800	17.0000	571.500	22.5000	336.550	13.2500	336.550	13.2500	3.2	1.5	5 560	11 600		47TS865734A	2	0.4	1.68	2.5	229
440	—	590	—	480	—	480	—	4	SP	8 580	18 700		47TS885948A-3	2-P	0.26	2.55	3.8	362
	—	620	—	454	—	454	—	4	1.5	8 240	16 100		47TS886245-1	1-P	0.33	2.03	3.02	430
	—	635	—	470	—	413	—	5	2	8 610	15 700		47TS886447	1	0.33	2.03	3.02	461
450	—	595	—	420	—	420	—	5	1.5	7 630	16 300		47TS906042	1-P	0.26	2.55	3.8	308
457.200	18.0000	596.900	23.5000	279.400	11.0000	276.225	10.8750	3.2	1.6	4 710	9 520		47TS916028C	2-P	0.47	1.43	2.12	191
	18.0000	596.900	23.5000	279.400	11.0000	276.225	10.8750	3.2	1.6	4 140	8 180		47TS916028D	2-P	0.7	0.97	1.44	187
460	—	620	—	470	—	470	—	4	1.5	8 810	19 300		47TS926247	1-P	0.26	2.55	3.8	412
479.425	18.8750	679.450	26.7500	495.300	19.5000	495.300	19.5000	6.4	2	10 100	19 600		47TS966850	1-P	0.33	2.03	3.02	562
480.000	18.8976	647.700	25.5000	417.512	16.4375	417.512	16.4375	6.4	SP	8 350	17 400		47TS966542	1-P	0.33	2.03	3.02	391
480	—	700	—	470	—	470	—	5	1.5	10 100	18 800		47TS967047	1-P	0.32	2.12	3.15	621
482.600	19.0000	615.950	24.2500	330.200	13.0000	330.200	13.0000	6.4	1.6	5 410	11 700		4TRS19B	1-P	0.44	1.54	2.3	240
	19.0000	615.950	24.2500	330.200	13.0000	330.200	13.0000	3.2	1.6	5 480	11 800		4TRS19C	2	0.4	1.68	2.5	229
	19.0000	615.950	24.2500	330.200	13.0000	330.200	13.0000	3.2	1.6	5 660	12 400		4TRS19D	2-P	0.4	1.68	2.5	239
	19.0000	615.950	24.2500	385.000	15.1575	385.000	15.1575	6.4	1.6	6 610	15 000		47TS976239	1-P	0.33	2.03	3.02	278
	19.0000	615.950	24.2500	420.000	16.5354	420.000	16.5354	6.4	1.6	6 390	14 500		47TS976242	1	0.33	2.03	3.02	302
	19.0000	615.950	24.2500	425.000	16.7323	425.000	16.7323	6.4	1.6	6 390	14 500		47TS976243	1	0.33	2.03	3.02	306
	19.0000	647.700	25.5000	417.512	16.4375	417.512	16.4375	6.4	1.6	8 350	17 400		47TS976542A	1-P	0.33	2.03	3.02	382

[Note] 1) SP indicates the specially chamfered from.

Sealed type four-row tapered roller bearings

d 488.950 ~ 711.200 mm

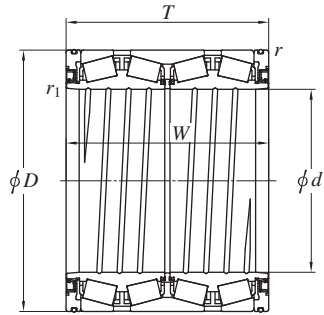

Design 1

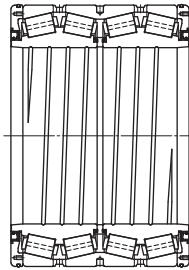

Design 1-P

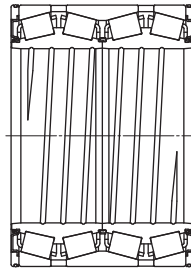

Design 2

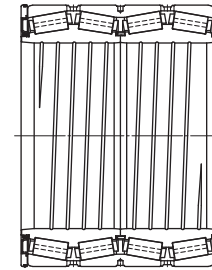

Design 2-P

Boundary dimensions								Basic load ratings (kN)		Fatigue load limit (kN) C_u	Bearing No.	Design	Constant e	Axial load factors		(Refer.) Mass (kg)		
d mm	D mm	T mm	W mm	r min.	r_1 ¹⁾ min.	C_r	C_{0r}	Y_2	Y_3									
488.950	19.2500	622.300	24.5000	365.125	14.3750	365.125	14.3750	6.4	1.5	5 420	12 200	1 110	47TS986236	1	0.4	1.68	2.5	270
492	—	655	—	480	—	480	—	5	1.5	9 310	21 200	1 830	47TS986648	1-P	0.33	2.03	3.02	449
509.948	20.0767	654.924	25.7844	379.000	14.9213	377.000	14.8425	6.4	1.5	6 730	15 200	1 350	4TRS510B	1-P	0.41	1.64	2.44	320
530	—	715	—	590	—	590	—	5	1.5	12 900	28 900	2 390	4TRS530A	1-P	0.26	2.55	3.8	664
558.800	22.0000	736.600	29.0000	372.263	14.6560	372.263	14.6560	7	SP	7 430	16 100	714	4TRS559J	1-P	0.34	1.97	2.93	425
	22.0000	736.600	29.0000	409.575	16.1250	409.575	16.1250	6	1.5	8 570	18 600	1 610	4TRS559C	1-P	0.35	1.95	2.9	475
	22.0000	736.600	29.0000	450.000	17.7165	450.000	17.7165	6	1.5	8 990	19 700	427	4TRS559A	1-P	0.35	1.95	2.9	507
	22.0000	736.600	29.0000	480.000	18.8976	480.000	18.8976	6	1.5	9 970	22 700	1 910	4TRS559B	1-P	0.4	1.68	2.5	547
	22.0000	736.600	29.0000	500.000	19.6850	500.000	19.6850	6	1.6	10 300	23 100	1 950	4TRS559	1-P	0.35	1.95	2.9	560
585.788	23.0625	771.525	30.3750	479.425	18.8750	479.425	18.8750	6.4	1.5	10 900	24 400	2 050	4TRS586A	1-P	0.33	2.03	3.02	613
595.312	23.4375	844.550	33.2500	615.950	24.2500	615.950	24.2500	6.4	3.6	15 900	32 200	2 610	4TRS595B	1-P	0.33	2.03	3.02	1 120
600	—	870	—	700	—	700	—	5	4	18 900	39 400	3 080	4TRS600A	1-P	0.33	2.03	3.02	1 370
609.600	24.0000	787.400	31.0000	361.950	14.2500	361.950	14.2500	6.4	3.2	7 420	14 900	1 310	4TRS610	1-P	0.4	1.68	2.5	430
	24.0000	813.562	32.0300	540.000	21.2598	540.000	21.2598	6.4	1.5	12 700	28 500	2 320	4TRS610A	1-P	0.33	2.03	3.02	775
679.450	26.7500	901.700	35.5000	552.450	21.7500	552.450	21.7500	6.4	3	13 900	30 600	2 450	4TRS679	1-P	0.33	2.03	3.02	951
685.800	27.0000	876.300	34.5000	355.600	14.0000	352.425	13.8750	6.4	3.2	7 690	16 300	1 400	4TRS686A	1-P	0.42	1.62	2.42	520
704.850	27.7500	914.400	36.0000	552.450	21.7500	552.450	21.7500	6.4	3.2	14 100	33 400	2 630	4TRS705	1-P	0.33	2.03	3.02	940
711.200	28.0000	914.400	36.0000	317.500	12.5000	317.500	12.5000	3.2	SP	7 620	16 700	1 420	4TRS711N	2-P	0.46	1.47	2.19	507
	28.0000	914.400	36.0000	387.350	15.2500	387.350	15.2500	6.4	3.2	8 980	19 400	1 620	4TRS711A	1-P	0.38	1.78	2.65	615
	28.0000	914.400	36.0000	410.000	16.1417	410.000	16.1417	6.4	3.2	9 550	20 500	1 730	4TRS711	1-P	0.44	1.54	2.29	670
	28.0000	914.400	36.0000	420.000	16.5354	420.000	16.5354	6.4	3.2	9 870	22 200	1 840	4TRS711L	1-P	0.4	1.68	2.5	678

[Note] 1) SP indicates the specially chamfered from.

d 800 mm

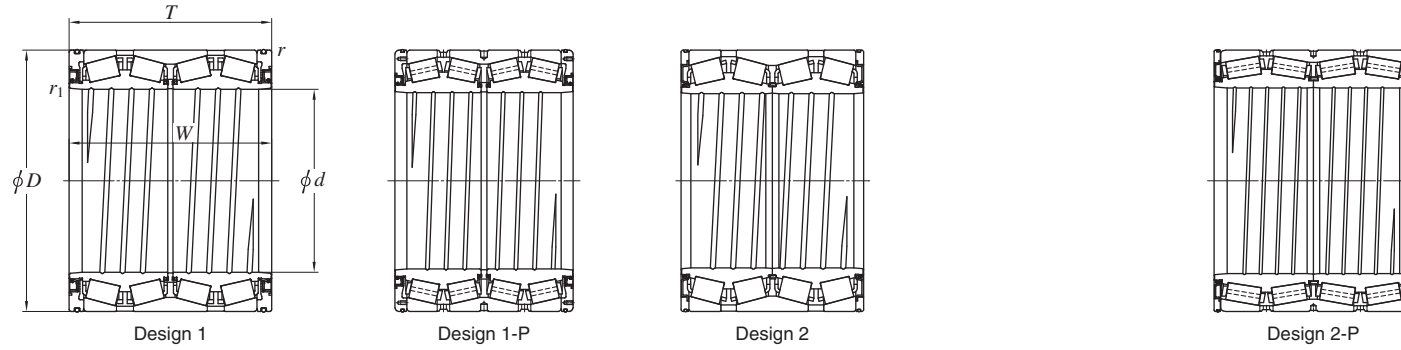

Boundary dimensions						Basic load ratings (kN)		Fatigue load limit (kN) C_u	Bearing No.	Design	Constant e	Axial load factors		(Refer.) Mass (kg)
d mm	D mm	T mm	W mm	r min.	r_1 min.	C_r	C_{0r}					Y_2	Y_3	
800	1 130	780	780	6	1.5	27 400	58 800	4 290	4TRS800	1-P	0.26	2.55	3.8	2 520

Spherical roller bearings

- Spherical roller bearings feature a large load rating capacity. This type of bearing is suitable for low- or medium-speed applications which involve heavy or impact loading.
- The spherical roller bearing is self-aligning, insensitive to misalignment of the shaft relative to the housing, and to shaft bending.
- Bearing with tapered bore can be easily mounted/dismounted by using an adapter assembly or withdrawal sleeve.
 - 1) 240 and 241 series 1 : 30 (supplementary code K30)
 - 2) Others 1 : 12 (supplementary code K)

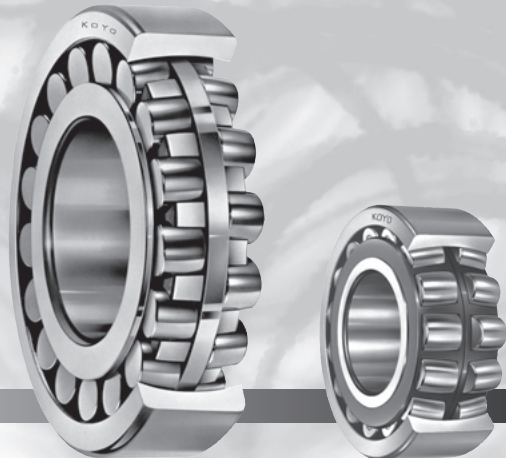

■ Cylindrical bore

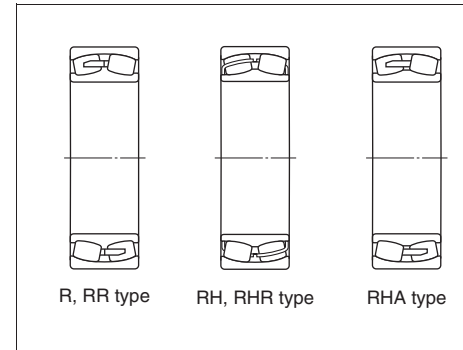

■ Tapered bore

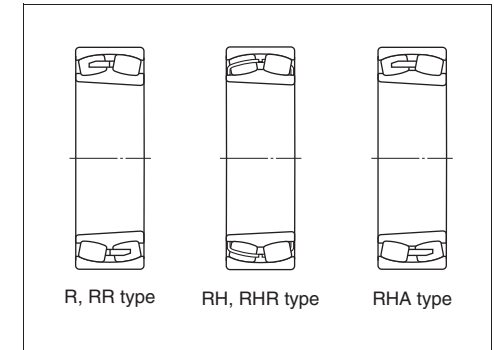

	R, RR type	RH, RHR type	RHA type
Roller	Convex asymmetrical roller	Convex symmetrical roller	Convex symmetrical roller
Cage	Copper alloy prong type machined cage	Pressed steel cage	Copper alloy integral type machined cage
Inner ring (with or without rib)	With center rib	Without center rib (floating guide ring)	Without center rib (floating guide ring)
	With ribs on both sides (to prevent rollers from falling)	Without ribs on both sides	With ribs on both sides (to prevent rollers from falling)
Characteristics	Superior to RH, RHR and RHA types in high-speed performance.	The load rating capacity is larger than that of R and RR type. (There are some exceptional cases due to different interior specifications.)	

- Outer rings can be provided with lubrication holes, a lubrication groove and an anti-rotation pin hole.

Supplementary code		Number of lubrication holes	Hole layout
With lubrication holes and lubrication groove	With lubrication holes, lubrication groove and anti-rotation pin hole		
W33	W3N	3 ¹⁾	3 equally spaced positions ¹⁾
W33A	W3NA	4	4 equally spaced positions
-	W3NB	5	6 equally spaced positions ²⁾
W33C	W3NC	6	6 equally spaced positions
-	W3ND	7	8 equally spaced positions ²⁾
W33T	-	8	8 equally spaced positions

- Inner rings can also be provided with lubrication holes and a lubrication groove.

Supplementary code	Inner ring		Outer ring	
	Number of lubrication holes	Lubrication groove	Number of lubrication holes	Lubrication groove
W513	3	-	3	○
W518	3	-	3	-
W26	3	-	-	-

[Notes] 1) Also 4 or 6 holes are provided.

2) One hole is used for the antirotation pin.

[Remark] Boldfaced codes indicate JTEKT standards.

■ Lubrication hole and lubrication groove dimensions
(W33, W33A, W33C, W33T)

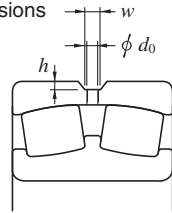

Unit : mm

Bore diameter number	Nominal bore diameter d	23900			23000			24000			23100			24100			22200			23200			21300			22300		
		d ₀	w	h	d ₀	w	h	d ₀	w	h	d ₀	w	h	d ₀	w	h	d ₀	w	h	d ₀	w	h	d ₀	w	h	d ₀	w	h
20	100	-	-	-	4	5	1	-	-	-	5	6	1.4	-	-	-	5	6	1.2	5	8	1.2	4	6	1.2	6	8	2
22	110	-	-	-	5	7	1	-	-	-	5	6	1.4	6	8	1.5	5	7	1.5	6	8	1.7	4	6	1.2	6	8	2
24	120	-	-	-	5	7	1	5	6	1.4	5	6	1.4	6	8	1.5	5	7	1.5	6	10	1.7	-	-	-	8	10	2.5
26	130	-	-	-	5	7	1.2	6	8	1.5	5	6	1.5	6	8	1.5	5	7	1.5	6	10	1.7	-	-	-	8	12	2.5
28	140	4	5	1	5	7	1.2	6	8	1.5	6	8	1.5	8	10	2	6	8	1.8	8	10	2.5	-	-	-	12	14	3
30	150	5	7	1	5	8	1.2	6	8	1.5	6	10	1.5	8	10	2	6	10	1.8	8	10	2.5	-	-	-	12	14	3
32	160	5	7	1.2	5	8	1.2	6	8	1.5	8	12	2	10	12	2	10	12	2.5	10	12	2.5	-	-	-	12	14	3
34	170	5	7	1.2	6	10	1.5	8	10	2	8	12	2	10	12	2	12	14	3	10	12	2.5	-	-	-	12	14	3
36	180	6	7	1.3	8	12	1.5	10	12	2.5	10	12	2.5	10	12	2	12	14	3	10	12	2.5	-	-	-	14	16.5	4
38	190	5	7	1.2	10	12	2.5	10	12	2.5	10	12	2.5	10	12	2	12	14	3	12	14	3	-	-	-	14	16.5	4
40	200	6	8	1.5	10	12	2.5	10	12	2.5	12	14	3	12	14	3	12	14	3	12	14	3	-	-	-	14	16.5	4
44	220	6	8	1.5	10	12	2.5	10	12	2.5	12	14	3	12	14	3	12	14	3	12	14	3	-	-	-	14	16.5	4
48	240	6	8	1.5	10	12	2.5	10	12	2.5	12	14	3	12	14	3	14	16.5	4	14	16.5	4	-	-	-	14	16.5	4
52	260	10	12	2.5	12	14	3	12	14	3	12	14	3	12	14	3	14	16.5	4	14	16.5	4	-	-	-	14	16.5	4
56	280	10	12	2.5	12	14	3	12	14	3	12	14	3	12	14	3	14	16.5	4	14	16.5	4	-	-	-	14	16.5	4
60	300	10	12	2.5	12	14	3	12	14	3	12	14	3	12	14	3	14	16.5	4	14	16.5	4	-	-	-	14	16.5	4
64	320	10	12	2.5	12	14	3	12	14	3	14	16.5	4	14	16.5	4	14	16.5	4	14	16.5	4	-	-	-	14	16.5	4
68	340	12	14	3	14	16.5	4	14	16.5	4	14	16.5	4	14	16.5	4	14	16.5	4	14	16.5	4	-	-	-	14	16.5	4
72	360	12	14	3	14	16.5	4	14	16.5	4	14	16.5	4	14	16.5	4	14	16.5	4	14	16.5	4	-	-	-	14	16.5	4
76	380	12	14	3	14	16.5	4	14	16.5	4	14	16.5	4	14	16.5	4	-	-	-	14	16.5	4	-	-	-	-	-	-
80	400	12	14	3	14	16.5	4	14	16.5	4	14	16.5	4	14	16.5	4	-	-	-	14	16.5	4	-	-	-	-	-	-
84	420	12	14	3	14	16.5	4	14	16.5	4	14	16.5	4	14	16.5	4	-	-	-	14	16.5	4	-	-	-	-	-	-
88	440	14	16.5	4	14	16.5	4	14	16.5	4	14	16.5	4	14	16.5	4	-	-	-	14	16.5	4	-	-	-	-	-	-
92	460	14	16.5	4	14	16.5	4	14	16.5	4	14	16.5	4	14	16.5	4	-	-	-	14	16.5	4	-	-	-	-	-	-
96	480	14	16.5	4	14	16.5	4	14	16.5	4	14	16.5	4	14	16.5	4	-	-	-	14	16.5	4	-	-	-	-	-	-
/500	500	14	16.5	4	14	16.5	4	14	16.5	4	14	16.5	4	14	16.5	5	-	-	-	14	16.5	4	-	-	-	-	-	-
/530	530	14	16.5	4	14	16.5	4	16	20	5	14	16.5	4	16	20	5	-	-	-	14	16.5	4	-	-	-	-	-	-
/560	560	14	16.5	4	14	16.5	4	16	20	5	14	16.5	4	16	20	5	-	-	-	14	16.5	4	-	-	-	-	-	-
/600	600	14	16.5	4	14	16.5	4	16	20	5	16	20	5	16	20	5	-	-	-	16	20	5	-	-	-	-	-	-
/630	630	14	16.5	4	14	16.5	4	16	20	5	16	20	5	16	20	5	-	-	-	16	20	5	-	-	-	-	-	-
/670	670	14	16.5	4	14	16.5	4	16	20	5	16	20	5	16	20	5	25	30	7	-	-	-	-	-	-	-	-	-
/710	710	14	16.5	4	14	16.5	4	16	20	5	16	20	5	25	30	7	-	-	-	-	-	-	-	-	-	-	-	-
/750	750	15	20	4	15	20	4	16	20	5	16	20	5	-	-	-	-	-	-	-	-	-	-	-	-	-	-	-
/800	800	15	20	4	15	20	4	16	20	5	16	20	5	-	-	-	-	-	-	-	-	-	-	-	-	-	-	-
/850	850	15	20	4	15	20	4	20	25	5	20	25	5	-	-	-	-	-	-	-	-	-	-	-	-	-	-	-
/900	900	16	20	5	15	20	5	20	25	5	20	25	5	-	-	-	-	-	-	-	-	-	-	-	-	-	-	-
/950	950	16	20	5	16	20	5	20	25	5	-	-	-	-	-	-	-	-	-	-	-	-	-	-	-	-	-	-
/1 000	1 000	16	20	5	16	20	5	20	25	5	-	-	-	-	-	-	-	-	-	-	-	-	-	-	-	-	-	-
/1 060	1 060	16	20	5	16	20	5	20	25	5	-	-	-	-	-	-	-	-	-	-	-	-	-	-	-	-	-	-
/1 120	1 120	16	20	5	-	-	-	20	25	5	-	-	-	-	-	-	-	-	-	-	-	-	-	-	-	-	-	-
/1 180	1 180	16	20	5	-	-	-	-	-	-	-	-	-	-	-	-	-	-	-	-	-	-	-	-	-	-	-	-
/1 250	1 250	16	20	5	-	-	-	-	-	-	-	-	-	-	-	-	-	-	-	-	-	-	-	-	-	-	-	-
/1 320	1 320	20	25	5	-	-	-	-	-	-	-	-	-	-	-	-	-	-	-	-	-	-	-	-	-	-	-	-
/1 400	1 400	20	25	5	-	-	-	-	-	-	-	-	-	-	-	-	-	-	-	-	-	-	-	-	-	-	-	-

Boundary dimensions	The dimensions of standard series are as specified in JIS B 1512.
Tolerances	As specified in JIS B 1514, class 0. (refer to Table 2-2 on page 18.) Refer to Table 2-10 on page 34 for the tolerance of tapered bores.
Allowable aligning angle	23800R 0.017 rad (1°) 24100R, RH, RHA 0.044 rad (2.5°) 23900R 0.026 rad (1.5°) 22200R, RR, RH, RHR, RHA 0.026 rad (1.5°) 23000R, RH, RHA 0.026 rad (1.5°) 23200R, RH, RHA 0.044 rad (2.5°) 24000R, RH, RHA 0.035 rad (2°) 21300R, RH 0.017 rad (1°) 23100R, RH, RHA 0.026 rad (1.5°) 22300R, RR, RH, RHR, RHA 0.035 rad (2°)
Radial internal clearance	(Refer to Table 4-6 on page 54.)
Equivalent radial load	<p>Dynamic equivalent radial load [Note] Refer to the specification table for the values of axial load factors Y_1, Y_2 and Y_0 and of constant e.</p> <p>(When $\frac{F_a}{F_r} \leq e$) $P_r = F_r + Y_1 F_a$</p> <p>(When $\frac{F_a}{F_r} > e$) $P_r = 0.67 F_r + Y_2 F_a$</p> <p>Static equivalent radial load</p> <p>$P_{0r} = F_r + Y_0 F_a$</p>

Spherical roller bearings

d 100 ~ (140) mm

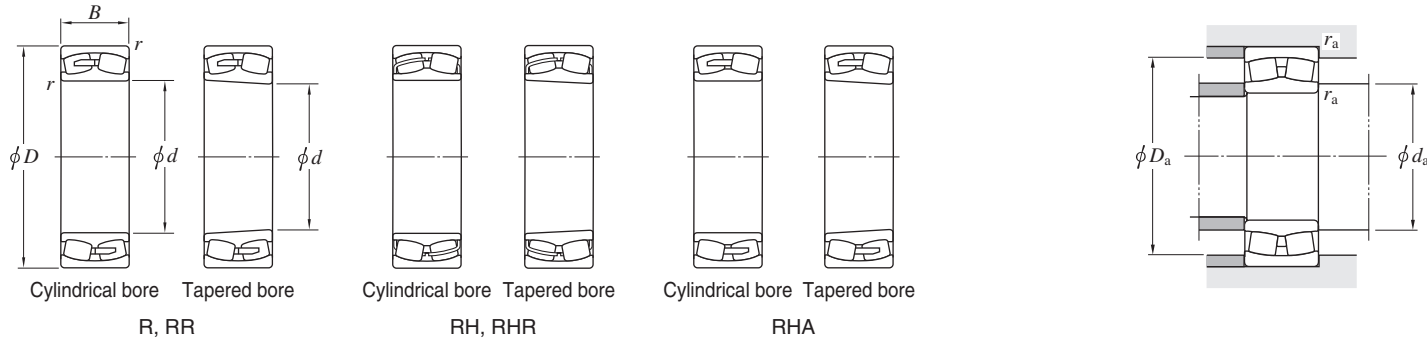

Boundary dimensions (mm)				Basic load ratings (kN)		Fatigue load limit (kN)	Bearing No.		Mounting dimensions (mm)			Constant	Axial load factors			(Refer.) Mass (kg)	
d	D	B	r (Refer.)	C _r	C _{0r}	C _u	Cylindrical bore	Tapered bore	d _a min.	D _a max.	r _a max.	e	Y ₁	Y ₂	Y ₀	Cylindrical bore	Tapered bore
100	150	37	1.5	262	332	33.7	23020RH	23020RHK	117	141	1.5	0.22	3.01	4.48	2.94	2.34	2.27
	180	46	2.1	470	481	47.6	22220RHR	22220RHRK	112	168	2	0.25	2.74	4.08	2.68	5.11	5.00
	180	60.3	2.1	533	629	53.5	23220RH	23220RHK	112	168	2	0.32	2.09	3.11	2.04	6.85	6.66
	215	47	3	519	524	40.2	21320RH	21320RHK	114	201	2.5	0.22	3.02	4.49	2.95	8.79	8.68
	215	73	3	875	877	63.9	22320RHR	22320RHRK	114	201	2.5	0.35	1.95	2.90	1.91	13.2	12.9
110	170	45	2	377	486	48.4	23022RH	23022RHK	120	160	2	0.24	2.84	4.23	2.78	3.85	3.74
	180	56	2	484	605	53.7	23122RH	23122RHK	120	170	2	0.29	2.36	3.51	2.31	5.72	5.54
	180	69	2	569	778	63.4	24122RH	24122RHK30	120	170	2	0.37	1.84	2.74	1.80	6.98	6.87
	200	53	2.1	612	642	58.7	22222RHR	22222RHRK	122	188	2	0.26	2.64	3.93	2.58	7.37	7.21
	200	69.8	2.1	672	792	65.4	23222RH	23222RHK	122	188	2	0.34	1.99	2.96	1.94	9.76	9.48
	240	50	3	604	616	46.0	21322RH	21322RHK	124	226	2.5	0.21	3.19	4.75	3.12	11.8	11.7
	240	80	3	1 040	1 040	77.7	22322RHR	22322RHRK	124	226	2.5	0.33	2.03	3.02	1.98	18.1	17.7
120	180	46	2	394	524	51.6	23024RH	23024RHK	130	170	2	0.23	2.95	4.40	2.89	4.20	4.07
	180	60	2	484	709	61.8	24024RH	24024RHK30	130	170	2	0.30	2.23	3.32	2.18	5.43	5.34
	200	62	2	571	714	61.2	23124RH	23124RHK	130	190	2	0.29	2.34	3.49	2.29	7.98	7.74
	200	80	2	733	1 020	78.6	24124RH	24124RHK30	130	190	2	0.38	1.75	2.61	1.72	10.2	10.0
	215	58	2.1	706	764	67.2	22224RHR	22224RHRK	132	203	2	0.26	2.60	3.87	2.54	9.31	9.10
	215	76	2.1	772	956	78.9	23224RH	23224RHK	132	203	2	0.34	1.97	2.94	1.93	12.2	11.8
	260	86	3	1 120	1 130	87.2	22324RHR	22324RHRK	134	246	2.5	0.33	2.03	3.02	1.98	22.8	22.3
130	200	52	2	509	674	63.6	23026RH	23026RHK	140	190	2	0.24	2.87	4.27	2.80	6.15	5.97
	200	69	2	625	914	77.3	24026RH	24026RHK30	140	190	2	0.32	2.14	3.18	2.09	8.03	7.90
	210	64	2	621	799	68.4	23126RH	23126RHK	140	200	2	0.28	2.42	3.61	2.37	8.71	8.44
	210	80	2	754	1 080	91.8	24126RH	24126RHK30	140	200	2	0.36	1.90	2.83	1.86	10.8	10.6
	230	64	3	821	914	74.4	22226RHR	22226RHRK	144	216	2.5	0.26	2.55	3.80	2.50	11.6	11.3
	230	80	3	880	1 090	89.4	23226RH	23226RHK	144	216	2.5	0.33	2.05	3.05	2.00	14.4	14.0
	280	93	4	1 310	1 340	98.6	22326RHR	22326RHRK	148	262	3	0.33	2.03	3.02	1.98	28.5	27.9
	140	210	53	2	530	723	67.9	23028RH	23028RHK	150	200	2	0.23	2.98	4.44	2.92	6.62

[Remark] For bearings with lubrication holes and lubrication grooves on the outer ring, refer to page 371 and 372.

d (140) ~ (170) mm

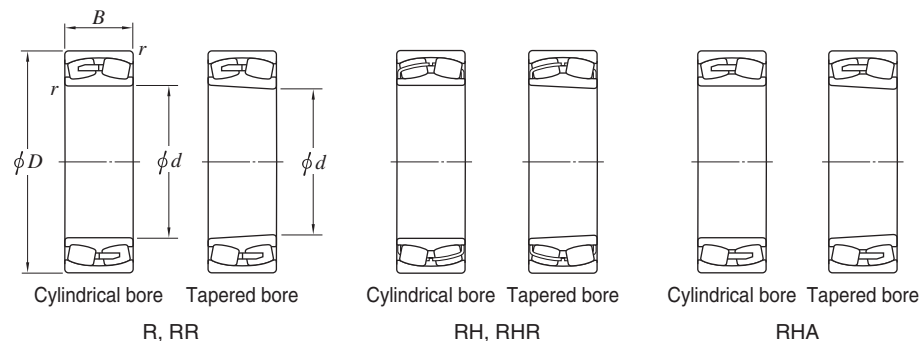

Boundary dimensions (mm)				Basic load ratings (kN)		Fatigue load limit (kN)	Bearing No.		Mounting dimensions (mm)			Constant	Axial load factors			(Refer.) Mass (kg)	
d	D	B	r (Refer.)	C_r	C_{0r}	C_u	Cylindrical bore	Tapered bore	d_a min.	D_a max.	r_a max.	e	Y_1	Y_2	Y_0	Cylindrical bore	Tapered bore
140	210	69	2	640	957	81.7	24028RH	24028RHK30	150	200	2	0.30	2.28	3.39	2.23	8.49	8.35
	225	68	2.1	710	940	79.6	23128RH	23128RHK	152	213	2	0.28	2.45	3.65	2.40	10.6	10.3
	225	85	2.1	853	1 220	90.7	24128RH	24128RHK30	152	213	2	0.36	1.89	2.82	1.85	13.1	12.9
	250	68	3	947	1 030	85.2	22228RHR	22228RHRK	154	236	2.5	0.26	2.60	3.87	2.54	14.5	14.2
	250	88	3	1 020	1 290	103	23228RH	23228RHK	154	236	2.5	0.34	1.99	2.96	1.95	19.0	18.4
	300	102	4	1 470	1 570	105	22328RH	22328RHK	158	282	3	0.35	1.95	2.90	1.90	35.7	34.9
150	210	45	2	418	622	62.5	23930R	23930RK	160	200	2	0.20	3.44	5.12	3.36	5.09	4.93
	225	56	2.1	579	797	76.3	23030RH	23030RHK	162	213	2	0.22	3.04	4.53	2.97	8.01	7.77
	225	75	2.1	724	1 100	90.3	24030RH	24030RHK30	162	213	2	0.30	2.23	3.32	2.18	10.6	10.4
	250	80	2.1	902	1 230	102	23130RH	23130RHK	162	238	2	0.30	2.24	3.34	2.19	16.4	15.9
	250	100	2.1	1 110	1 590	116	24130RH	24130RHK30	162	238	2	0.38	1.77	2.64	1.73	19.9	19.6
	270	73	3	1 080	1 200	102	22230RHR	22230RHRK	164	256	2.5	0.25	2.69	4.00	2.63	18.9	18.5
	270	96	3	1 200	1 540	121	23230RH	23230RHK	164	256	2.5	0.34	1.96	2.93	1.92	24.5	23.8
	320	108	4	1 540	1 600	175	22330R	22330RK	168	302	3	0.38	1.78	2.64	1.74	43.6	42.7
	320	108	4	1 620	1 740	121	22330RHA	22330RHAK	168	302	3	0.35	1.93	2.87	1.88	40.3	39.4
160	220	45	2	426	649	65.4	23932R	23932RK	170	210	2	0.19	3.60	5.37	3.52	5.37	5.20
	240	60	2.1	667	924	86.0	23032RH	23032RHK	172	228	2	0.22	3.01	4.48	2.94	9.74	9.44
	240	80	2.1	829	1 270	103	24032RH	24032RHK30	172	228	2	0.30	2.24	3.34	2.19	12.9	12.7
	270	86	2.1	1 070	1 430	117	23132RH	23132RHK	172	258	2	0.30	2.22	3.30	2.17	20.8	20.2
	270	109	2.1	1 270	1 720	145	24132RR	24132RRK30	172	258	2	0.39	1.72	2.56	1.68	25.9	25.5
	290	80	3	1 110	1 270	127	22232R	22232RK	174	276	2.5	0.28	2.40	3.57	2.35	23.4	22.9
	290	80	3	1 120	1 320	97.1	22232RHA	22232RHAK	174	276	2.5	0.27	2.49	3.71	2.44	21.9	21.4
	290	104	3	1 290	1 650	163	23232RR	23232RK	174	276	2.5	0.38	1.79	2.66	1.75	31.0	30.1
	290	104	3	1 370	1 780	139	23232RHA	23232RHAK	174	276	2.5	0.36	1.87	2.78	1.83	29.4	28.5
	340	114	4	1 720	1 790	188	22332R	22332RK	178	322	3	0.38	1.76	2.62	1.72	51.9	51.0
	340	114	4	1 780	1 940	135	22332RHA	22332RHAK	178	322	3	0.35	1.94	2.89	1.90	48.0	47.1
	170	230	45	2	441	691	69.6	23934R	23934RK	180	220	2	0.18	3.78	5.63	3.70	5.67
260		67	2.1	795	1 090	97.9	23034RH	23034RHK	182	248	2	0.23	2.90	4.31	2.83	13.2	12.8

[Remark] For bearings with lubrication holes and lubrication grooves on the outer ring, refer to page 371 and 372.

Spherical roller bearings

d (170) ~ (190) mm

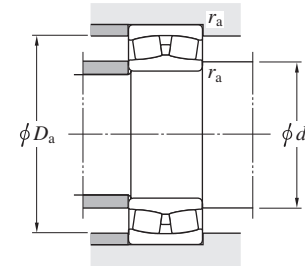
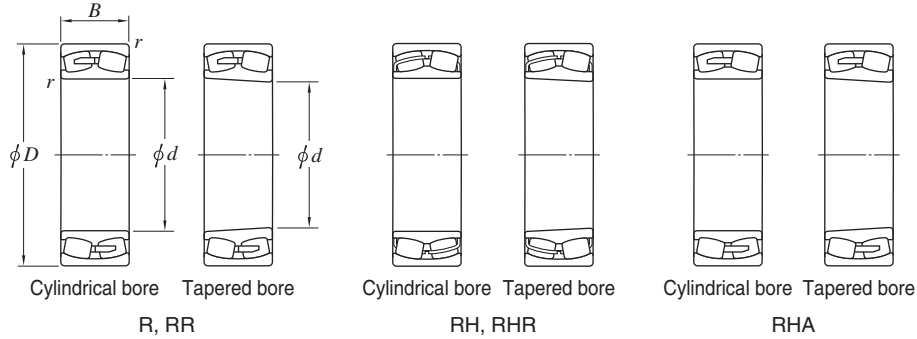

Boundary dimensions (mm)				Basic load ratings (kN)		Fatigue load limit (kN)	Bearing No.		Mounting dimensions (mm)			Constant	Axial load factors			(Refer.) Mass (kg)	
d	D	B	r (Refer.)	C _r	C _{0r}	C _u	Cylindrical bore	Tapered bore	d _a min.	D _a max.	r _a max.	e	Y ₁	Y ₂	Y ₀	Cylindrical bore	Tapered bore
170	260	90	2.1	1 010	1 540	120	24034RH	24034RHK30	182	248	2	0.32	2.11	3.15	2.07	17.5	17.2
	280	88	2.1	1 150	1 550	124	23134RH	23134RHK	182	268	2	0.29	2.30	3.43	2.25	21.9	21.2
	280	109	2.1	1 320	1 820	154	24134RR	24134RRK30	182	268	2	0.37	1.80	2.68	1.76	27.2	26.8
	310	86	4	1 190	1 390	141	22234R	22234RK	188	292	3	0.29	2.29	3.41	2.24	29.0	28.4
	310	86	4	1 260	1 490	109	22234RHA	22234RHAK	188	292	3	0.28	2.45	3.64	2.39	27.1	26.5
	310	110	4	1 560	1 920	127	23234RR	23234RRK	188	292	3	0.37	1.85	2.75	1.80	37.2	36.1
	310	110	4	1 520	1 940	147	23234RHA	23234RHAK	188	292	3	0.36	1.89	2.82	1.85	35.6	34.6
	360	120	4	1 830	1 920	206	22334R	22334RK	188	342	3	0.38	1.77	2.64	1.73	62.0	60.8
	360	120	4	1 990	2 200	150	22334RHA	22334RHAK	188	342	3	0.35	1.95	2.91	1.91	57.3	56.1
	180	250	52	2	599	939	88.9	23936R	23936RK	190	240	2	0.19	3.55	5.29	3.48	8.22
280		74	2.1	966	1 330	118	23036RH	23036RHK	192	268	2	0.24	2.84	4.23	2.78	17.4	16.9
280		100	2.1	1 170	1 710	138	24036RR	24036RRK30	192	268	2	0.34	2.00	2.98	1.96	23.4	23.0
300		96	3	1 260	1 800	165	23136R	23136RK	194	286	2.5	0.33	2.04	3.04	2.00	28.4	27.5
300		96	3	1 330	1 790	139	23136RHA	23136RHAK	194	286	2.5	0.31	2.19	3.25	2.14	26.5	25.6
300		118	3	1 530	2 120	176	24136RR	24136RRK30	194	286	2.5	0.38	1.78	2.65	1.74	34.4	33.9
300		118	3	1 510	2 240	155	24136RHA	24136RHAK30	194	286	2.5	0.38	1.79	2.66	1.75	31.8	31.2
320		86	4	1 220	1 450	165	22236R	22236RK	198	302	3	0.28	2.37	3.53	2.32	30.5	29.8
320		86	4	1 320	1 610	118	22236RHA	22236RHAK	198	302	3	0.26	2.55	3.80	2.50	28.5	27.8
320		112	4	1 640	2 100	134	23236RR	23236RRK	198	302	3	0.36	1.87	2.78	1.83	39.8	38.6
320		112	4	1 660	2 170	166	23236RHA	23236RHAK	198	302	3	0.34	1.97	2.93	1.92	37.7	36.5
380		126	4	2 180	2 360	263	22336R	22336RK	198	362	3	0.36	1.89	2.81	1.84	71.4	69.9
380		126	4	2 180	2 410	163	22336RHA	22336RHAK	198	362	3	0.34	1.97	2.94	1.93	66.0	64.5
190		260	52	2	608	969	90.7	23938R	23938RK	200	250	2	0.18	3.69	5.50	3.61	8.40
	290	75	2.1	923	1 370	132	23038R	23038RK	202	278	2	0.25	2.67	3.97	2.61	18.8	18.2
	290	75	2.1	992	1 430	115	23038RHA	23038RHAK	202	278	2	0.25	2.75	4.10	2.69	17.2	16.6
	290	100	2.1	1 240	1 840	161	24038RR	24038RRK30	202	278	2	0.33	2.06	3.07	2.02	24.5	24.1
	290	100	2.1	1 230	1 920	152	24038RHA	24038RHAK30	202	278	2	0.32	2.14	3.19	2.09	22.4	22.0
	320	104	3	1 370	2 000	162	23138R	23138RK	204	306	2.5	0.34	1.96	2.92	1.92	35.5	34.4
	320	104	3	1 520	2 080	161	23138RHA	23138RHAK	204	306	2.5	0.31	2.14	3.19	2.10	33.2	32.1

[Remark] For bearings with lubrication holes and lubrication grooves on the outer ring, refer to page 371 and 372.

Spherical roller bearings

d (190) ~ (220) mm

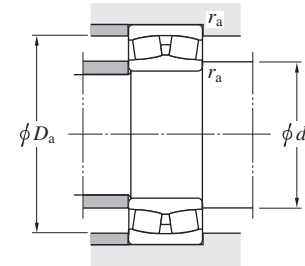
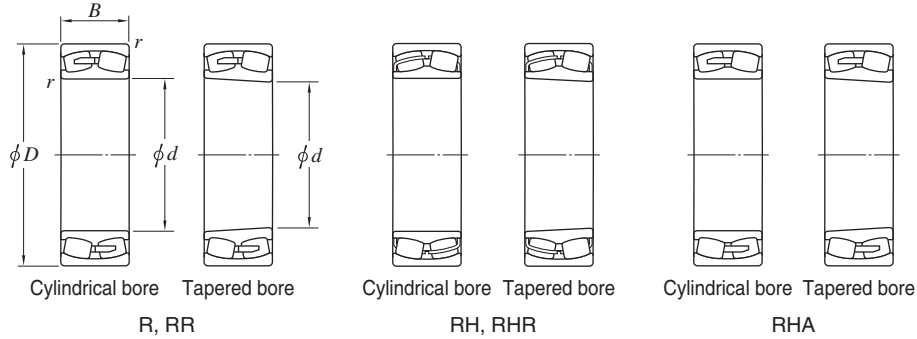

Boundary dimensions (mm)				Basic load ratings (kN)		Fatigue load limit (kN)	Bearing No.		Mounting dimensions (mm)			Constant	Axial load factors			(Refer.) Mass (kg)	
d	D	B	r (Refer.)	C _r	C _{0r}	C _u	Cylindrical bore	Tapered bore	d _a min.	D _a max.	r _a max.	e	Y ₁	Y ₂	Y ₀	Cylindrical bore	Tapered bore
190	320	128	3	1 750	2 470	198	24138RR	24138RRK30	204	306	2.5	0.39	1.74	2.59	1.70	43.0	42.4
	320	128	3	1 770	2 630	179	24138RHA	24138RHAK30	204	306	2.5	0.38	1.76	2.63	1.72	40.1	39.5
	340	92	4	1 390	1 730	172	22238R	22238RK	208	322	3	0.29	2.29	3.41	2.24	37.4	36.6
	340	92	4	1 420	1 770	128	22238RHA	22238RHAK	208	322	3	0.27	2.52	3.76	2.46	34.9	34.1
	340	120	4	1 830	2 370	160	23238RR	23238RRK	208	322	3	0.36	1.86	2.76	1.81	48.5	47.1
	340	120	4	1 870	2 470	185	23238RHA	23238RHAK	208	322	3	0.35	1.94	2.89	1.90	44.9	43.5
	400	132	5	2 380	2 610	258	22338R	22338RK	212	378	4	0.38	1.79	2.66	1.75	84.1	82.4
	400	132	5	2 430	2 810	192	22338RHA	22338RHAK	212	378	4	0.34	1.99	2.97	1.95	77.7	76.0
	200	280	60	2.1	753	1 190	109	23940R	23940RK	212	268	2	0.20	3.44	5.13	3.37	12.0
310		82	2.1	1 120	1 670	155	23040R	23040RK	212	298	2	0.26	2.62	3.90	2.56	24.1	23.4
310		82	2.1	1 180	1 680	133	23040RHA	23040RHAK	212	298	2	0.25	2.68	3.99	2.62	22.0	21.3
310		109	2.1	1 430	2 110	180	24040RR	24040RRK30	212	298	2	0.33	2.02	3.00	1.97	31.2	30.7
310		109	2.1	1 440	2 230	173	24040RHA	24040RHAK30	212	298	2	0.33	2.06	3.07	2.02	28.5	28.0
340		112	3	1 740	2 350	186	23140RR	23140RRK	214	326	2.5	0.33	2.04	3.03	1.99	43.3	42.0
340		112	3	1 730	2 340	178	23140RHA	23140RHAK	214	326	2.5	0.32	2.10	3.13	2.06	40.8	39.5
340		140	3	2 030	2 820	222	24140RR	24140RRK30	214	326	2.5	0.40	1.68	2.49	1.64	53.3	52.5
340		140	3	2 000	2 970	196	24140RHA	24140RHAK30	214	326	2.5	0.41	1.65	2.46	1.62	49.5	48.7
360		98	4	1 620	2 050	138	22240RR	22240RRK	218	342	3	0.30	2.26	3.36	2.21	45.0	44.0
360		98	4	1 630	2 030	146	22240RHA	22240RHAK	218	342	3	0.27	2.50	3.72	2.45	42.0	41.0
360		128	4	1 950	2 610	228	23240R	23240RK	218	342	3	0.38	1.79	2.67	1.75	58.1	56.4
360		128	4	2 080	2 780	209	23240RHA	23240RHAK	218	342	3	0.35	1.92	2.86	1.88	55.1	53.4
420		138	5	2 510	2 750	288	22340R	22340RK	222	398	4	0.38	1.80	2.68	1.76	95.4	93.5
420		138	5	2 570	2 920	193	22340RHA	22340RHAK	222	398	4	0.34	1.99	2.97	1.95	88.1	86.2
220	300	60	2.1	792	1 300	119	23944R	23944RK	232	288	2	0.18	3.70	5.50	3.61	13.0	12.6
	340	90	3	1 230	1 890	173	23044R	23044RK	234	326	2.5	0.26	2.55	3.80	2.50	31.5	30.6
	340	90	3	1 370	1 950	148	23044RHA	23044RHAK	234	326	2.5	0.25	2.69	4.01	2.63	28.8	27.9
	340	118	3	1 660	2 480	208	24044RR	24044RRK30	234	326	2.5	0.33	2.04	3.04	2.00	40.5	39.8
	340	118	3	1 680	2 630	199	24044RHA	24044RHAK30	234	326	2.5	0.33	2.08	3.09	2.03	37.0	36.4
	370	120	4	1 810	2 700	205	23144R	23144RK	238	352	3	0.34	2.00	2.98	1.96	54.8	53.2

[Remark] For bearings with lubrication holes and lubrication grooves on the outer ring, refer to page 371 and 372.

Spherical roller bearings

d (220) ~ (260) mm

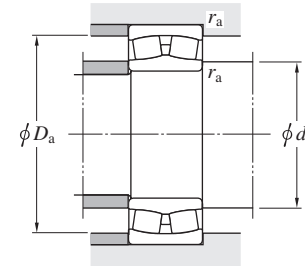
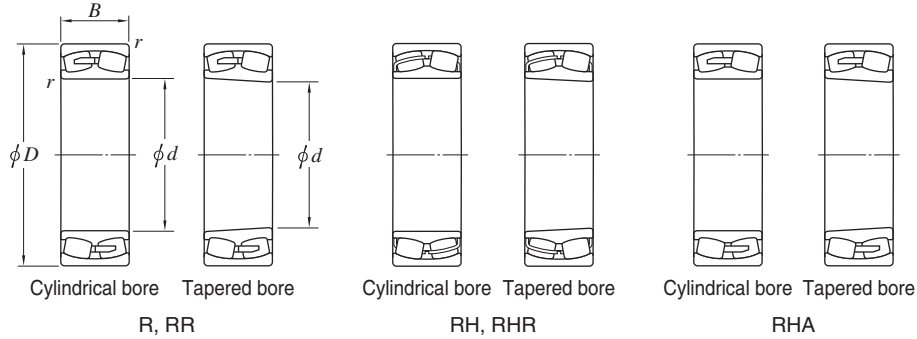

Boundary dimensions (mm)				Basic load ratings (kN)		Fatigue load limit (kN)	Bearing No.		Mounting dimensions (mm)			Constant	Axial load factors			(Refer.) Mass (kg)	
d	D	B	r (Refer.)	C _r	C _{0r}	C _u	Cylindrical bore	Tapered bore	d _a min.	D _a max.	r _a max.	e	Y ₁	Y ₂	Y ₀	Cylindrical bore	Tapered bore
220	370	120	4	2 000	2 790	208	23144RHA	23144RHAK	238	352	3	0.31	2.15	3.20	2.10	51.2	49.6
	370	150	4	2 360	3 390	258	24144RR	24144RRK30	238	352	3	0.39	1.71	2.55	1.67	67.3	66.2
	370	150	4	2 330	3 550	229	24144RHA	24144RHAK30	238	352	3	0.40	1.69	2.52	1.65	62.0	61.0
	400	108	4	2 000	2 410	257	22244RR	22244RRK	238	382	3	0.28	2.40	3.57	2.34	60.3	59.0
	400	108	4	1 980	2 440	168	22244RHA	22244RHAK	238	382	3	0.27	2.52	3.76	2.47	58.8	57.5
	400	144	4	2 350	3 200	259	23244R	23244RK	238	382	3	0.39	1.71	2.55	1.68	81.6	79.2
	400	144	4	2 520	3 350	239	23244RHA	23244RHAK	238	382	3	0.36	1.89	2.81	1.85	77.4	75.0
	460	145	5	2 980	3 380	359	22344R	22344RK	242	438	4	0.34	2.00	2.99	1.96	124	122
	460	145	5	2 960	3 470	226	22344RHA	22344RHAK	242	438	4	0.32	2.08	3.09	2.03	115	113
	240	320	60	2.1	814	1 380	128	23948R	23948RK	252	308	2	0.17	3.95	5.88	3.86	14.0
360		92	3	1 480	2 190	161	23048RR	23048RRK	254	346	2.5	0.25	2.73	4.07	2.67	33.9	32.9
360		92	3	1 470	2 180	166	23048RHA	23048RHAK	254	346	2.5	0.24	2.83	4.21	2.77	31.9	30.9
360		118	3	1 750	2 710	228	24048RR	24048RRK30	254	346	2.5	0.31	2.20	3.27	2.15	43.5	42.9
360		118	3	1 750	2 840	215	24048RHA	24048RHAK30	254	346	2.5	0.30	2.24	3.33	2.19	39.6	39.0
400		128	4	2 280	3 220	213	23148RR	23148RRK	258	382	3	0.32	2.11	3.14	2.06	67.2	65.1
400		128	4	2 270	3 200	233	23148RHA	23148RHAK	258	382	3	0.31	2.19	3.25	2.14	63.1	61.1
400		160	4	2 640	3 850	287	24148RR	24148RRK30	258	382	3	0.39	1.75	2.60	1.71	82.7	81.4
400		160	4	2 670	4 130	262	24148RHA	24148RHAK30	258	382	3	0.39	1.72	2.56	1.68	76.6	75.3
440		120	4	2 390	2 940	295	22248R	22248RK	258	422	3	0.29	2.35	3.50	2.30	85.0	83.2
440		120	4	2 400	2 990	202	22248RHA	22248RHAK	258	422	3	0.27	2.49	3.71	2.43	79.4	77.6
440		160	4	3 050	3 970	310	23248RR	23248RRK	258	422	3	0.38	1.78	2.64	1.74	110	107
440		160	4	3 080	4 130	289	23248RHA	23248RHAK	258	422	3	0.36	1.87	2.78	1.83	104	101
500		155	5	3 360	4 200	347	22348R	22348RK	262	478	4	0.35	1.94	2.89	1.90	157	154
500		155	5	3 400	3 990	255	22348RHA	22348RHAK	262	478	4	0.32	2.12	3.16	2.07	145	142
260		360	75	2.1	1 140	1 880	160	23952R	23952RK	272	348	2	0.19	3.54	5.27	3.46	24.0
	400	104	4	1 670	2 570	212	23052R	23052RK	278	382	3	0.25	2.65	3.95	2.59	50.7	49.3
	400	104	4	1 850	2 720	201	23052RHA	23052RHAK	278	382	3	0.25	2.75	4.10	2.69	46.3	44.9
	400	140	4	2 280	3 570	282	24052RR	24052RRK30	278	382	3	0.33	2.02	3.01	1.98	66.3	65.2
	400	140	4	2 270	3 670	265	24052RHA	24052RHAK30	278	382	3	0.33	2.06	3.07	2.02	60.3	59.4

[Remark] For bearings with lubrication holes and lubrication grooves on the outer ring, refer to page 371 and 372.

Spherical roller bearings

d (260) ~ (300) mm

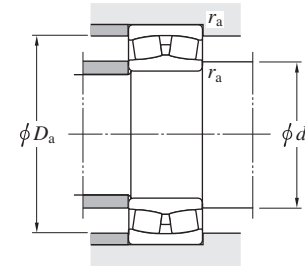
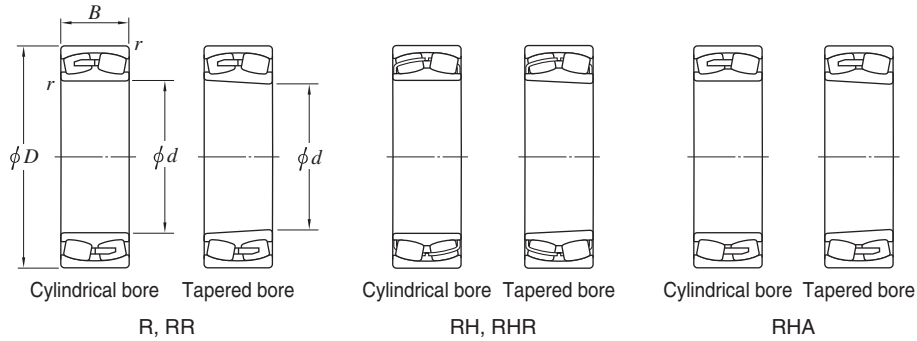

Boundary dimensions (mm)				Basic load ratings (kN)		Fatigue load limit (kN)	Bearing No.		Mounting dimensions (mm)			Constant	Axial load factors			(Refer.) Mass (kg)	
d	D	B	r (Refer.)	C _r	C _{0r}	C _u	Cylindrical bore	Tapered bore	d _a min.	D _a max.	r _a max.	e	Y ₁	Y ₂	Y ₀	Cylindrical bore	Tapered bore
260	440	144	4	2 760	3 850	231	23152RR	23152RRK	278	422	3	0.33	2.05	3.06	2.01	92.2	89.4
	440	144	4	2 790	4 000	285	23152RHA	23152RHAK	278	422	3	0.32	2.12	3.16	2.08	87.4	84.6
	440	180	4	3 250	4 700	345	24152RR	24152RRK30	278	422	3	0.40	1.69	2.51	1.65	114	112
	440	180	4	3 210	4 950	309	24152RHA	24152RHAK30	278	422	3	0.41	1.66	2.47	1.62	106	105
	480	130	5	2 800	3 460	347	22252R	22252RK	282	458	4	0.28	2.40	3.57	2.35	110	108
	480	130	5	2 790	3 430	226	22252RHA	22252RHAK	282	458	4	0.27	2.50	3.72	2.44	103	101
	480	174	5	3 440	4 640	326	23252R	23252RK	282	458	4	0.40	1.69	2.51	1.65	144	140
	480	174	5	3 590	4 900	280	23252RHA	23252RHAK	282	458	4	0.36	1.87	2.78	1.83	137	133
	540	165	6	3 540	4 380	363	22352R	22352RK	288	512	5	0.35	1.94	2.89	1.90	196	192
	540	165	6	3 900	4 620	290	22352RHA	22352RHAK	288	512	5	0.31	2.15	3.21	2.11	181	177
280	380	75	2.1	1 160	1 960	165	23956R	23956RK	292	368	2	0.18	3.74	5.57	3.66	26.0	25.2
	420	106	4	1 790	2 860	235	23056R	23056RK	298	402	3	0.25	2.74	4.08	2.68	54.5	52.9
	420	106	4	1 940	2 950	218	23056RHA	23056RHAK	298	402	3	0.24	2.87	4.27	2.80	49.8	48.2
	420	140	4	2 370	3 780	291	24056RR	24056RRK30	298	402	3	0.31	2.15	3.21	2.11	70.2	69.1
	420	140	4	2 390	4 000	287	24056RHA	24056RHAK30	298	402	3	0.31	2.20	3.28	2.15	64.0	62.9
	460	146	5	2 910	4 160	250	23156RR	23156RRK	302	438	4	0.32	2.14	3.18	2.09	98.8	95.7
	460	146	5	2 940	4 290	304	23156RHA	23156RHAK	302	438	4	0.30	2.22	3.30	2.17	93.4	90.3
	460	180	5	3 390	5 140	370	24156RR	24156RRK30	302	438	4	0.38	1.79	2.67	1.75	122	120
	460	180	5	3 320	5 240	322	24156RHA	24156RHAK30	302	438	4	0.38	1.76	2.62	1.72	113	112
	500	130	5	2 640	3 380	308	22256R	22256RK	302	478	4	0.28	2.42	3.60	2.37	114	112
	500	130	5	2 900	3 670	240	22256RHA	22256RHAK	302	478	4	0.26	2.64	3.93	2.58	106	104
	500	176	5	3 370	4 910	323	23256R	23256RK	302	478	4	0.37	1.83	2.72	1.79	153	149
	500	176	5	3 770	5 300	365	23256RHA	23256RHAK	302	478	4	0.35	1.95	2.91	1.91	145	141
	580	175	6	3 930	4 910	407	22356R	22356RK	308	552	5	0.34	1.98	2.95	1.93	229	225
	580	175	6	4 390	5 260	325	22356RHA	22356RHAK	308	552	5	0.31	2.19	3.25	2.14	212	208
300	420	90	3	1 610	2 610	220	23960R	23960RK	314	406	2.5	0.20	3.42	5.09	3.34	40.0	38.8
	460	118	4	2 190	3 480	286	23060R	23060RK	318	442	3	0.25	2.69	4.00	2.63	75.8	73.7
	460	118	4	2 370	3 700	255	23060RHA	23060RHAK	318	442	3	0.24	2.79	4.16	2.73	68.9	66.8
	460	160	4	2 950	4 690	354	24060RR	24060RRK30	318	442	3	0.33	2.04	3.04	2.00	99.5	97.9

[Remark] For bearings with lubrication holes and lubrication grooves on the outer ring, refer to page 371 and 372.

Spherical roller bearings

d (300) ~ (340) mm

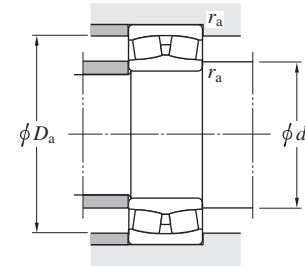
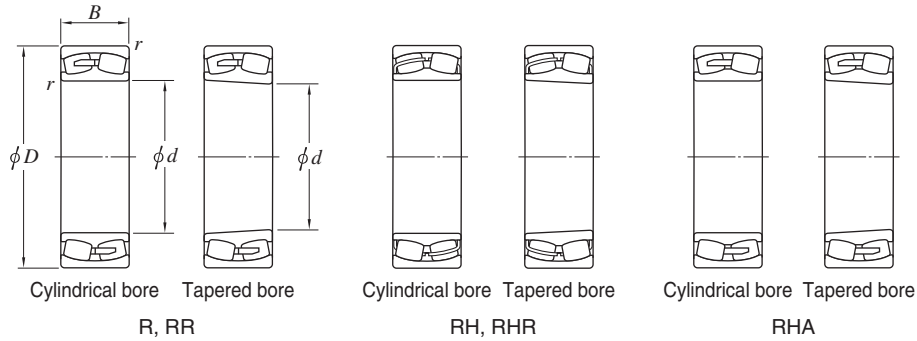

Boundary dimensions (mm)				Basic load ratings (kN)		Fatigue load limit (kN)	Bearing No.		Mounting dimensions (mm)			Constant	Axial load factors			(Refer.) Mass (kg)	
d	D	B	r (Refer.)	C _r	C _{0r}	C _u	Cylindrical bore	Tapered bore	d _a min.	D _a max.	r _a max.	e	Y ₁	Y ₂	Y ₀	Cylindrical bore	Tapered bore
300	460	160	4	2 950	4 910	350	24060RHA	24060RHAK30	318	442	3	0.32	2.09	3.11	2.04	90.7	89.1
	500	160	5	3 450	5 030	351	23160RR	23160RRK	322	478	4	0.32	2.09	3.11	2.04	131	127
	500	160	5	3 430	4 970	345	23160RHA	23160RHAK	322	478	4	0.31	2.18	3.25	2.13	123	119
	500	200	5	4 160	6 280	433	24160RR	24160RRK30	322	478	4	0.40	1.67	2.49	1.63	162	160
	500	200	5	4 030	6 420	385	24160RHA	24160RHAK30	322	478	4	0.39	1.72	2.56	1.68	150	148
	540	140	5	3 360	4 330	412	22260R	22260RK	322	518	4	0.27	2.48	3.69	2.43	145	142
	540	140	5	3 320	4 360	284	22260RHA	22260RHAK	322	518	4	0.26	2.62	3.90	2.56	135	132
	540	192	5	4 300	5 910	401	23260R	23260RK	322	518	4	0.37	1.83	2.72	1.79	197	192
	540	192	5	4 440	6 310	429	23260RHA	23260RHAK	322	518	4	0.35	1.93	2.88	1.89	187	182
	620	185	7.5	4 890	5 430	555	22360R	22360RK	336	584	6	0.32	2.09	3.10	2.04	289	284
320	440	90	3	1 670	2 870	233	23964R	23964RK	334	426	2.5	0.19	3.61	5.38	3.53	43.0	41.7
	480	121	4	2 290	3 740	295	23064R	23064RK	338	462	3	0.24	2.76	4.11	2.70	81.2	78.8
	480	121	4	2 490	3 850	278	23064RHA	23064RHAK	338	462	3	0.24	2.87	4.27	2.80	74.5	72.1
	480	160	4	3 020	4 920	382	24064RR	24064RRK30	338	462	3	0.31	2.16	3.22	2.11	105	103
	480	160	4	3 060	5 230	363	24064RHA	24064RHAK30	338	462	3	0.31	2.21	3.29	2.16	93.4	91.4
	540	176	5	3 650	5 700	366	23164R	23164RK	342	518	4	0.33	2.04	3.04	2.00	171	166
	540	176	5	4 040	5 960	404	23164RHA	23164RHAK	342	518	4	0.32	2.13	3.17	2.08	160	155
	540	218	5	4 680	6 950	486	24164RR	24164RRK30	342	518	4	0.39	1.72	2.56	1.68	208	205
	540	218	5	4 550	7 190	429	24164RHA	24164RHAK30	342	518	4	0.40	1.70	2.52	1.66	199	196
	580	150	5	3 420	4 540	385	22264R	22264RK	342	558	4	0.28	2.41	3.59	2.35	175	171
	580	208	5	4 550	6 550	496	23264R	23264RK	342	558	4	0.38	1.76	2.62	1.72	249	242
	580	208	5	5 020	7 030	464	23264RHA	23264RHAK	342	558	4	0.36	1.90	2.83	1.86	236	229
340	460	90	3	1 680	2 980	242	23968R	23968RK	354	446	2.5	0.18	3.82	5.69	3.74	45.0	43.6
	520	133	5	2 670	4 330	353	23068R	23068RK	362	498	4	0.25	2.69	4.00	2.63	108	105
	520	133	5	2 930	4 470	312	23068RHA	23068RHAK	362	498	4	0.24	2.80	4.18	2.74	98.7	95.7
	520	180	5	3 680	5 970	432	24068RR	24068RRK30	362	498	4	0.33	2.06	3.06	2.01	142	140
	520	180	5	3 720	6 330	430	24068RHA	24068RHAK30	362	498	4	0.32	2.11	3.14	2.06	130	128
	580	190	5	4 130	6 430	472	23168R	23168RK	362	558	4	0.34	1.97	2.93	1.93	216	210
	580	190	5	4 620	6 720	449	23168RHA	23168RHAK	362	558	4	0.32	2.11	3.14	2.06	202	196

[Remark] For bearings with lubrication holes and lubrication grooves on the outer ring, refer to page 371 and 372.

d (340) ~ 380 mm

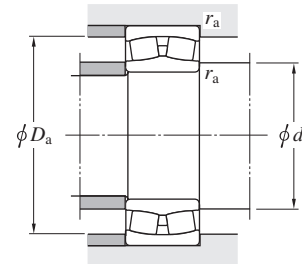
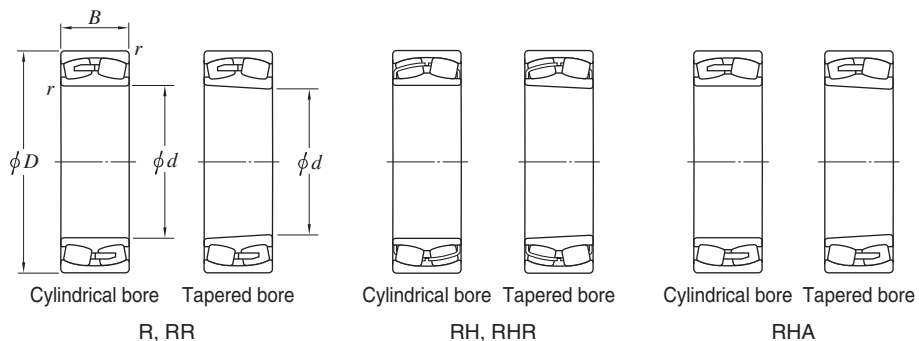

Boundary dimensions (mm)				Basic load ratings (kN)		Fatigue load limit (kN) Cu	Bearing No.		Mounting dimensions (mm)			Constant e	Axial load factors			(Refer.) Mass (kg)	
d	D	B	r (Refer.)	Cr	Cor		Cylindrical bore	Tapered bore	da min.	Da max.	ra max.		Y1	Y2	Y0	Cylindrical bore	Tapered bore
340	580	243	5	5 570	8 400	564	24168RR	24168RRK30	362	558	4	0.41	1.64	2.45	1.61	270	266
	580	243	5	5 490	8 810	449	24168RHA	24168RHAK30	362	558	4	0.42	1.61	2.39	1.57	259	255
	620	165	6	4 430	5 430	551	22268R	22268RK	368	592	5	0.28	2.43	3.61	2.37	221	216
	620	224	6	5 130	7 560	526	23268R	23268RK	368	592	5	0.38	1.77	2.63	1.73	306	297
	620	224	6	5 690	8 030	517	23268RHA	23268RHAK	368	592	5	0.36	1.88	2.81	1.84	290	281
	360	480	90	3	1 710	3 060	248	23972R	23972RK	374	466	2.5	0.17	3.95	5.88	3.86	46.5
540		134	5	2 860	4 800	375	23072R	23072RK	382	518	4	0.24	2.76	4.11	2.70	115	111
540		134	5	3 040	4 770	334	23072RHA	23072RHAK	382	518	4	0.23	2.92	4.34	2.85	105	101
540		180	5	3 810	6 300	465	24072RR	24072RRK30	382	518	4	0.31	2.15	3.21	2.11	149	147
540		180	5	3 810	6 620	446	24072RHA	24072RHAK30	382	518	4	0.30	2.22	3.30	2.17	135	133
600		192	5	4 740	7 040	459	23172R	23172RK	382	578	4	0.33	2.07	3.09	2.03	228	221
600		192	5	4 830	7 210	474	23172RHA	23172RHAK	382	578	4	0.31	2.19	3.25	2.14	213	206
600		243	5	5 080	7 690	437	24172R	24172RK30	382	578	4	0.39	1.74	2.59	1.70	287	283
600		243	5	5 580	9 180	517	24172RHA	24172RHAK30	382	578	4	0.40	1.69	2.51	1.65	274	270
650		170	6	4 710	5 830	583	22272R	22272RK	388	622	5	0.27	2.47	3.68	2.42	248	243
650		232	6	6 080	8 810	548	23272R	23272RK	388	622	5	0.37	1.83	2.72	1.79	346	336
650		232	6	6 220	9 050	591	23272RHA	23272RHAK	388	622	5	0.35	1.92	2.85	1.87	328	318
380	520	106	4	2 220	3 940	295	23976R	23976RK	398	502	3	0.19	3.62	5.39	3.54	70.0	67.9
	560	135	5	2 910	4 970	355	23076R	23076RK	402	538	4	0.24	2.79	4.16	2.73	122	118
	560	135	5	3 160	5 080	354	23076RHA	23076RHAK	402	538	4	0.22	3.03	4.51	2.96	112	108
	560	180	5	3 900	6 590	486	24076RR	24076RRK30	402	538	4	0.30	2.26	3.36	2.21	156	154
	560	180	5	3 900	6 910	454	24076RHA	24076RHAK30	402	538	4	0.29	2.32	3.45	2.27	142	139
	620	194	5	4 520	7 320	442	23176R	23176RK	402	598	4	0.31	2.18	3.24	2.13	240	233
	620	194	5	5 030	7 700	503	23176RHA	23176RHAK	402	598	4	0.30	2.26	3.36	2.21	224	217
	620	243	5	5 300	8 220	467	24176R	24176RK30	402	598	4	0.38	1.78	2.65	1.74	302	297
	620	243	5	5 870	9 840	561	24176RHA	24176RHAK30	402	598	4	0.38	1.78	2.65	1.74	288	283
	680	240	6	6 510	9 500	590	23276R	23276RK	408	652	5	0.36	1.85	2.76	1.81	386	375
	680	240	6	6 660	9 760	622	23276RHA	23276RHAK	408	652	5	0.35	1.94	2.89	1.90	365	354

[Remark] For bearings with lubrication holes and lubrication grooves on the outer ring, refer to page 371 and 372.

Spherical roller bearings

d 400 ~ (440) mm

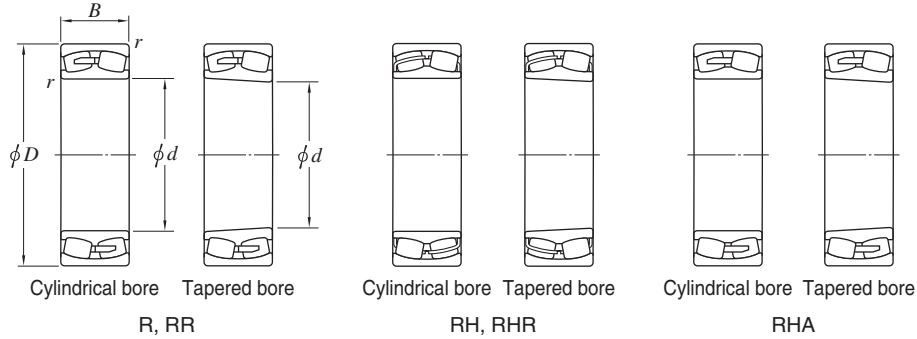

Boundary dimensions (mm)				Basic load ratings (kN)		Fatigue load limit (kN)	Bearing No.		Mounting dimensions (mm)			Constant	Axial load factors			(Refer.) Mass (kg)	
d	D	B	r (Refer.)	C _r	C _{0r}	C _u	Cylindrical bore	Tapered bore	d _a min.	D _a max.	r _a max.	e	Y ₁	Y ₂	Y ₀	Cylindrical bore	Tapered bore
400	540	106	4	2 350	4 300	320	23980R	23980RK	418	522	3	0.18	3.76	5.59	3.67	73.0	70.7
	600	148	5	3 390	5 790	408	23080R	23080RK	422	578	4	0.24	2.84	4.23	2.78	155	151
	600	148	5	3 690	5 860	398	23080RHA	23080RHAK	422	578	4	0.23	2.94	4.37	2.87	142	138
	600	200	5	4 820	8 110	444	24080R	24080RK30	422	578	4	0.32	2.09	3.12	2.05	206	203
	600	200	5	4 620	8 140	535	24080RHA	24080RHAK30	422	578	4	0.31	2.21	3.29	2.16	192	189
	650	200	6	4 730	7 780	521	23180R	23180RK	428	622	5	0.31	2.19	3.25	2.14	273	265
	650	200	6	5 410	8 300	542	23180RHA	23180RHAK	428	622	5	0.29	2.30	3.43	2.25	255	247
	650	250	6	5 840	9 140	499	24180R	24180RK30	428	622	5	0.37	1.82	2.70	1.78	338	333
	650	250	6	6 290	10 600	600	24180RHA	24180RHAK30	428	622	5	0.37	1.82	2.71	1.78	322	317
	720	256	6	6 540	9 850	590	23280R	23280RK	428	692	5	0.37	1.80	2.69	1.76	468	454
	720	256	6	7 320	10 600	665	23280RHA	23280RHAK	428	692	5	0.35	1.92	2.86	1.88	441	427
	420	560	106	4	2 330	4 320	331	23984R	23984RK	438	542	3	0.17	3.91	5.82	3.82	76.0
620		150	5	3 500	6 120	412	23084R	23084RK	442	598	4	0.23	2.90	4.31	2.83	164	159
620		150	5	3 820	6 230	425	23084RHA	23084RHAK	442	598	4	0.22	3.02	4.49	2.95	150	145
620		200	5	4 510	7 600	438	24084R	24084RK30	442	598	4	0.30	2.23	3.32	2.18	212	209
620		200	5	4 730	8 490	555	24084RHA	24084RHAK30	442	598	4	0.29	2.31	3.44	2.26	198	195
700		224	6	5 620	9 110	583	23184R	23184RK	448	672	5	0.33	2.03	3.02	1.98	363	352
700		224	6	6 330	9 630	616	23184RHA	23184RHAK	448	672	5	0.31	2.19	3.25	2.14	339	328
700		280	6	6 840	10 600	574	24184R	24184RK30	448	672	5	0.40	1.71	2.54	1.67	445	438
700		280	6	7 420	12 400	685	24184RHA	24184RHAK30	448	672	5	0.39	1.72	2.56	1.68	425	418
760		272	7.5	8 130	11 500	754	23284R	23284RK	456	724	6	0.37	1.84	2.74	1.80	556	540
760		272	7.5	8 230	11 900	735	23284RHA	23284RHAK	456	724	6	0.36	1.90	2.83	1.86	525	508
440		600	118	4	2 910	5 330	387	23988R	23988RK	458	582	3	0.18	3.75	5.58	3.66	101
	650	157	6	3 790	6 540	455	23088R	23088RK	468	622	5	0.24	2.76	4.11	2.70	188	183
	650	157	6	4 230	6 910	465	23088RHA	23088RHAK	468	622	5	0.22	3.04	4.53	2.97	172	167
	650	212	6	4 910	8 320	475	24088R	24088RK30	468	622	5	0.29	2.35	3.50	2.30	247	243
	650	212	6	5 290	9 560	618	24088RHA	24088RHAK30	468	622	5	0.30	2.28	3.39	2.23	231	227
	720	226	6	5 800	9 600	591	23188R	23188RK	468	692	5	0.33	2.08	3.09	2.03	378	366
	720	226	6	6 590	10 300	655	23188RHA	23188RHAK	468	692	5	0.30	2.25	3.34	2.20	353	341

[Remark] For bearings with lubrication holes and lubrication grooves on the outer ring, refer to page 371 and 372.

Spherical roller bearings

d (440) ~ (500) mm

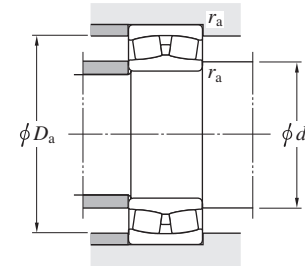
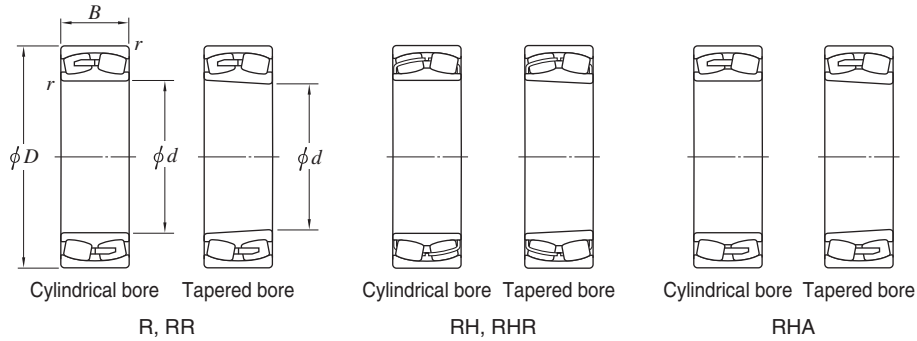

Boundary dimensions (mm)				Basic load ratings (kN)		Fatigue load limit (kN) C _u	Bearing No.		Mounting dimensions (mm)	Constant e	Axial load factors			(Refer.) Mass (kg)			
d	D	B	r (Refer.)	C _r	C _{0r}		Cylindrical bore	Tapered bore			d _a min.	D _a max.	r _a max.	Y ₁	Y ₂	Y ₀	Cylindrical bore
440	720	280	6	7 080	11 200	589	24188R	24188RK30	468	692	5	0.38	1.76	2.62	1.72	460	453
	720	280	6	7 540	12 900	707	24188RHA	24188RHAK30	468	692	5	0.38	1.79	2.67	1.75	439	432
	790	280	7.5	8 580	12 300	793	23288R	23288RK	476	754	6	0.36	1.86	2.77	1.82	613	595
	790	280	7.5	8 670	12 700	776	23288RHA	23288RHAK	476	754	6	0.35	1.93	2.88	1.89	580	562
460	600	90	3	1 800	3 660	306	23896R	23896RK	476	586	2.5	0.13	5.06	7.53	4.95	60.4	58.4
	620	118	4	2 890	5 350	404	23992R	23992RK	478	602	3	0.17	3.89	5.79	3.80	107	104
	680	163	6	4 060	7 170	480	23092R	23092RK	488	652	5	0.23	2.92	4.34	2.85	215	209
	680	163	6	4 520	7 430	497	23092RHA	23092RHAK	488	652	5	0.22	3.04	4.53	2.97	197	191
	680	218	6	5 740	10 100	536	24092R	24092RK30	488	652	5	0.30	2.23	3.32	2.18	277	272
	680	218	6	5 660	10 300	656	24092RHA	24092RHAK30	488	652	5	0.29	2.33	3.46	2.27	259	254
	760	240	7.5	6 510	10 800	648	23192R	23192RK	496	724	6	0.33	2.07	3.09	2.03	450	436
	760	240	7.5	7 240	11 200	697	23192RHA	23192RHAK	496	724	6	0.30	2.22	3.31	2.17	420	406
	760	300	7.5	7 320	12 200	597	24192R	24192RK30	496	724	6	0.35	1.95	2.90	1.91	550	541
	760	300	7.5	8 390	14 200	746	24192RHA	24192RHAK30	496	724	6	0.38	1.75	2.61	1.72	525	516
	830	296	7.5	9 520	13 700	867	23292R	23292RK	496	794	6	0.36	1.85	2.76	1.81	720	699
	830	296	7.5	9 600	14 200	856	23292RHA	23292RHAK	496	794	6	0.35	1.92	2.85	1.87	679	658
480	650	128	5	3 290	6 130	446	23996R	23996RK	502	628	4	0.18	3.75	5.59	3.67	123	119
	700	165	6	4 190	7 540	505	23096R	23096RK	508	672	5	0.22	3.01	4.47	2.94	225	218
	700	165	6	4 670	7 860	532	23096RHA	23096RHAK	508	672	5	0.22	3.12	4.64	3.05	206	199
	700	218	6	5 540	9 650	514	24096R	24096RK30	508	672	5	0.29	2.32	3.45	2.26	287	282
	700	218	6	5 800	10 700	492	24096RHA	24096RHAK30	508	672	5	0.28	2.41	3.59	2.35	268	263
	790	248	7.5	6 840	11 500	698	23196R	23196RK	516	754	6	0.32	2.09	3.12	2.05	503	488
	790	248	7.5	7 740	12 000	638	23196RHA	23196RHAK	516	754	6	0.30	2.24	3.34	2.19	470	455
	790	308	7.5	8 730	14 800	707	24196R	24196RK30	516	754	6	0.39	1.74	2.59	1.70	606	597
	790	308	7.5	9 880	15 900	792	24196RHA	24196RHAK30	516	754	6	0.38	1.78	2.65	1.74	580	568
	870	310	7.5	10 500	15 100	953	23296R	23296RK	516	834	6	0.36	1.85	2.75	1.81	831	807
	870	310	7.5	10 600	15 700	791	23296RHA	23296RHAK	516	834	6	0.35	1.91	2.85	1.87	785	761
	500	670	128	5	3 330	6 310	447	239/500R	239/500RK	522	648	4	0.17	3.87	5.76	3.79	131

[Remark] For bearings with lubrication holes and lubrication grooves on the outer ring, refer to page 371 and 372.

Spherical roller bearings

d (500) ~ 600 mm

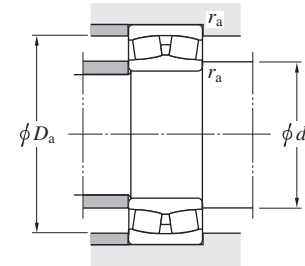
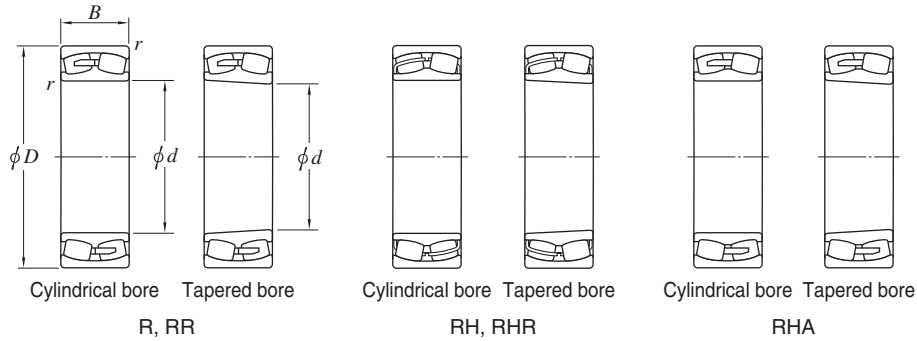

Boundary dimensions (mm)				Basic load ratings (kN)		Fatigue load limit (kN)	Bearing No.		Mounting dimensions (mm)			Constant	Axial load factors			(Refer.) Mass (kg)	
d	D	B	r (Refer.)	C _r	C _{0r}	C _u	Cylindrical bore	Tapered bore	d _a min.	D _a max.	r _a max.	e	Y ₁	Y ₂	Y ₀	Cylindrical bore	Tapered bore
500	720	167	6	4 490	8 090	561	230/500R	230/500RK	528	692	5	0.23	2.94	4.37	2.87	235	228
	720	218	6	5 620	10 300	545	240/500R	240/500RK30	528	692	5	0.28	2.39	3.56	2.34	297	292
	830	264	7.5	7 750	13 000	708	231/500R	231/500RK	536	794	6	0.33	2.05	3.05	2.00	595	577
	830	325	7.5	9 350	15 900	763	241/500R	241/500RK30	536	794	6	0.36	1.85	2.76	1.81	712	701
	920	336	7.5	11 000	16 700	908	232/500R	232/500RK	536	884	6	0.39	1.74	2.59	1.70	1 020	992
530	710	136	5	3 720	7 120	508	239/530R	239/530RK	552	688	4	0.17	3.86	5.75	3.78	157	152
	780	185	6	5 130	9 050	624	230/530R	230/530RK	558	752	5	0.24	2.84	4.23	2.78	314	304
	780	185	6	5 710	9 600	620	230/530RHA	230/530RHAK	558	752	5	0.22	3.08	4.59	3.02	307	297
	780	250	6	6 620	11 700	616	240/530R	240/530RK30	558	752	5	0.30	2.26	3.36	2.21	414	408
	870	272	7.5	9 010	14 200	874	231/530R	231/530RK	566	834	6	0.32	2.14	3.18	2.09	661	641
	870	335	7.5	10 300	17 200	847	241/530R	241/530RK30	566	834	6	0.38	1.78	2.65	1.74	796	784
	980	355	9.5	13 100	18 900	1 160	232/530R	232/530RK	574	936	8	0.37	1.82	2.71	1.78	1 230	1 200
560	680	90	3	2 050	4 470	366	238/560R	238/560RK	574	666	2	0.12	5.70	8.48	5.57	70.0	67.0
	750	140	5	3 880	7 350	528	239/560R	239/560RK	582	728	4	0.17	3.96	5.90	3.87	182	176
	750	140	5	3 900	7 470	517	239/560RHA	239/560RHAK	582	728	4	0.16	4.35	6.48	4.26	178	172
	820	195	6	5 690	10 300	678	230/560R	230/560RK	588	792	5	0.24	2.83	4.21	2.77	353	342
	820	258	6	7 280	12 800	693	240/560R	240/560RK30	588	792	5	0.29	2.34	3.49	2.29	468	460
	920	280	7.5	9 800	15 500	963	231/560R	231/560RK	596	884	6	0.31	2.20	3.27	2.15	763	740
	920	355	7.5	10 800	17 500	865	241/560R	241/560RK30	596	884	6	0.39	1.75	2.60	1.71	945	930
	1 030	365	9.5	14 000	20 300	1 240	232/560R	232/560RK	604	986	8	0.36	1.86	2.77	1.82	1 390	1 350
	1 030	365	9.5	14 400	21 900	970	232/560RR	232/560RRK	604	986	8	0.36	1.86	2.77	1.82	1 400	1 360
600	800	150	5	4 420	8 550	592	239/600R	239/600RK	622	778	4	0.17	3.94	5.87	3.86	218	211
	870	200	6	6 890	11 900	722	230/600RR	230/600RRK	628	842	5	0.22	3.08	4.59	3.02	405	393
	870	200	6	6 830	12 300	789	230/600RRHA	230/600RRHAK	628	842	5	0.21	3.24	4.83	3.17	406	394
	870	272	6	8 130	15 000	758	240/600R	240/600RK30	628	842	5	0.30	2.27	3.38	2.22	546	538
	980	300	7.5	11 400	18 400	1 100	231/600R	231/600RK	636	944	6	0.31	2.18	3.25	2.13	917	888
	980	375	7.5	12 400	20 600	963	241/600R	241/600RK30	636	944	6	0.38	1.77	2.63	1.73	1 120	1 100
	1 090	388	9.5	16 100	24 000	1 410	232/600R	232/600RK	644	1 046	8	0.36	1.85	2.76	1.81	1 640	1 590

[Remark] For bearings with lubrication holes and lubrication grooves on the outer ring, refer to page 371 and 372.

Spherical roller bearings

d 630 ~ 800 mm

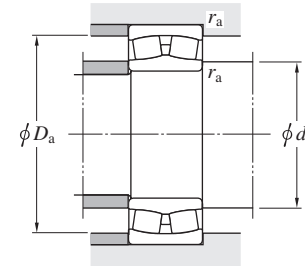
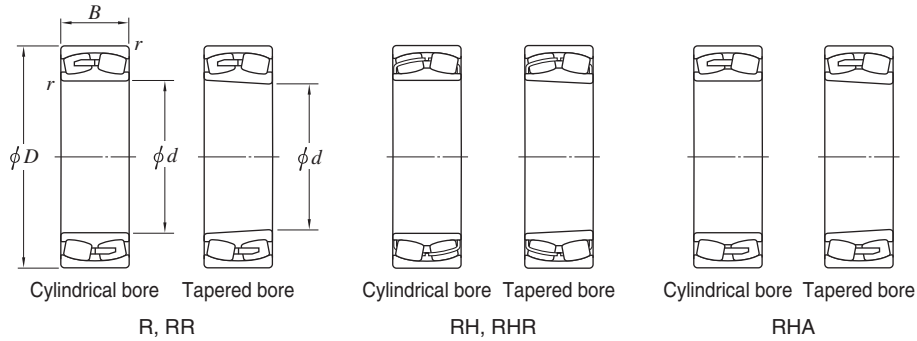

Boundary dimensions (mm)				Basic load ratings (kN)		Fatigue load limit (kN)	Bearing No.		Mounting dimensions (mm)			Constant	Axial load factors			(Refer.) Mass (kg)	
d	D	B	r (Refer.)	C _r	C _{0r}	C _u	Cylindrical bore	Tapered bore	d _a min.	D _a max.	r _a max.	e	Y ₁	Y ₂	Y ₀	Cylindrical bore	Tapered bore
630	850	165	6	5 060	9 680	657	239/630R	239/630RK	658	822	5	0.18	3.81	5.67	3.73	277	268
	920	212	7.5	7 530	13 000	813	230/630RHA	230/630RHAK	666	884	6	0.21	3.19	4.75	3.12	484	469
	920	290	7.5	9 030	16 600	832	240/630R	240/630RK30	666	884	6	0.29	2.30	3.42	2.25	659	650
	920	290	7.5	9 490	17 600	1 080	240/630RHA	240/630RHAK30	666	884	6	0.28	2.37	3.53	2.32	654	643
	1 030	315	7.5	12 100	19 500	1 150	231/630R	231/630RK	666	994	6	0.31	2.19	3.26	2.14	1 070	1 040
	1 030	400	7.5	14 600	25 000	1 160	241/630R	241/630RK30	666	994	6	0.38	1.75	2.61	1.72	1 330	1 310
	1 150	412	12	18 000	27 100	1 560	232/630R	232/630RK	684	1 096	10	0.37	1.84	2.74	1.80	1 940	1 880
670	900	170	6	5 540	10 800	730	239/670R	239/670RK	698	872	5	0.17	3.92	5.83	3.83	317	308
	980	230	7.5	8 610	15 500	978	230/670R	230/670RK	706	944	6	0.22	3.01	4.47	2.94	609	589
	980	308	7.5	10 900	20 400	983	240/670R	240/670RK30	706	944	6	0.3	2.28	3.39	2.23	813	800
	1 090	336	7.5	13 300	21 800	1 250	231/670R	231/670RK	706	1 054	6	0.31	2.17	3.23	2.12	1 270	1 240
	1 090	412	7.5	14 700	24 800	766	241/670R	241/670RK30	706	1 054	6	0.37	1.83	2.73	1.79	1 520	1 500
710	950	180	6	6 440	12 900	849	239/710R	239/710RK	738	922	5	0.17	3.89	5.79	3.80	365	353
	1 030	236	7.5	9 000	16 300	1 020	230/710R	230/710RK	746	994	6	0.22	3.05	4.54	2.98	681	657
	1 030	315	7.5	11 700	22 000	1 320	240/710RHA	240/710RHAK	746	994	8	0.28	2.41	3.59	2.35	886	871
	1 150	345	9.5	14 900	24 800	1 420	231/710R	231/710RK	754	1 106	8	0.30	2.22	3.30	2.17	1 440	1 400
	1 150	438	9.5	18 200	32 200	1 420	241/710R	241/710RK30	754	1 106	8	0.36	1.88	2.80	1.84	1 790	1 760
750	1 000	185	6	6 590	13 100	867	239/750R	239/750RK	778	972	5	0.17	4.00	5.95	3.91	410	396
	1 090	250	7.5	9 680	17 500	1 130	230/750R	230/750RK	786	1 054	6	0.22	3.14	4.67	3.07	809	781
	1 090	250	7.5	10 300	18 600	1 130	230/750RHA	230/750RHAK	786	1 054	6	0.21	3.20	4.76	3.12	799	775
	1 090	335	7.5	12 100	23 400	1 110	240/750R	240/750RK30	786	1 054	6	0.28	2.39	3.55	2.33	1 060	1 040
	1 220	365	9.5	16 700	28 000	1 590	231/750R	231/750RK	794	1 176	8	0.30	2.22	3.31	2.17	1 720	1 670
800	1 060	195	6	7 420	15 200	974	239/800R	239/800RK	828	1 032	5	0.17	4.02	5.99	3.93	480	464
	1 060	195	6	7 310	14 900	956	239/800RHA	239/800RHAK	828	1 032	5	0.15	4.47	6.65	4.37	480	464
	1 150	258	7.5	10 800	20 100	1 240	230/800R	230/800RK	836	1 114	6	0.21	3.15	4.69	3.08	909	876
	1 150	345	7.5	14 100	27 500	1 290	240/800R	240/800RK30	836	1 114	6	0.28	2.44	3.64	2.39	1 190	1 170
	1 280	375	9.5	17 400	29 400	1 640	231/800R	231/800RK	844	1 236	8	0.29	2.34	3.48	2.29	1 910	1 850

[Remark] For bearings with lubrication holes and lubrication grooves on the outer ring, refer to page 371 and 372.

d 850 ~ 1 400 mm

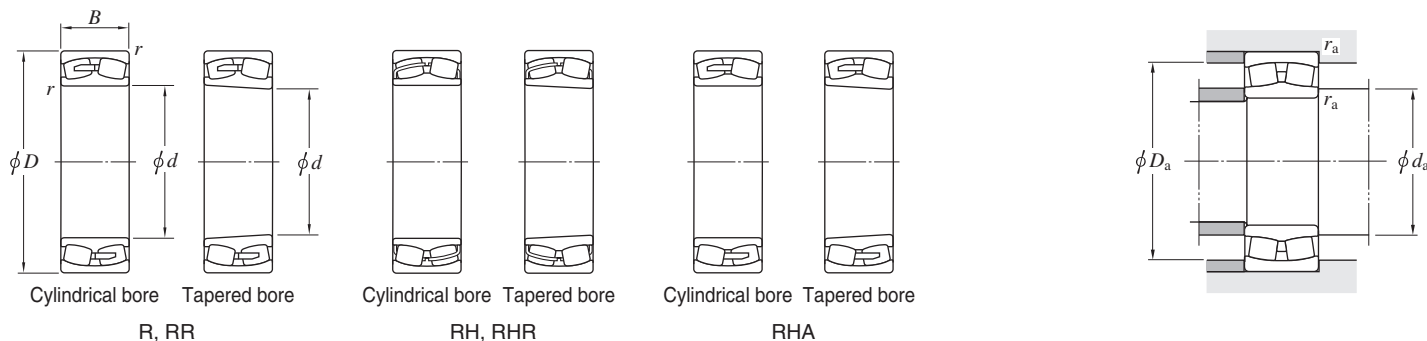

Boundary dimensions (mm)				Basic load ratings (kN)		Fatigue load limit (kN) C_u	Bearing No.		Mounting dimensions (mm)			Constant e	Axial load factors			(Refer.) Mass (kg)	
d	D	B	r (Refer.)	C_r	C_{0r}		Cylindrical bore	Tapered bore	d_a min.	D_a max.	r_a max.		Y_1	Y_2	Y_0	Cylindrical bore	Tapered bore
850	1 120	200	6	8 020	16 700	1 070	239/850R	239/850RK	878	1 092	5	0.16	4.14	6.17	4.05	545	528
	1 220	272	7.5	12 000	22 600	1 360	230/850R	230/850RK	886	1 184	6	0.21	3.17	4.72	3.10	1 080	1 050
	1 220	365	7.5	14 700	29 000	1 300	240/850R	240/850RK30	886	1 184	6	0.28	2.34	3.61	2.37	1 410	1 390
	1 360	400	12	20 200	34 200	1 920	231/850R	231/850RK	904	1 306	10	0.30	2.26	3.37	2.21	2 290	2 220
900	1 180	206	6	8 580	18 100	1 160	239/900R	239/900RK	928	1 152	5	0.16	4.24	6.32	4.15	610	590
	1 280	280	7.5	12 900	24 800	1 450	230/900R	230/900RK	936	1 244	6	0.21	3.20	4.77	3.13	1 200	1 160
	1 280	375	7.5	17 000	34 100	1 660	240/900RHA	240/900RHAK	936	1 244	8	0.26	2.61	3.89	2.56	1 560	1 540
	1 420	412	12	21 200	37 100	2 100	231/900R	231/900RK	954	1 366	10	0.29	2.29	3.42	2.24	2 530	2 450
950	1 250	224	7.5	9 750	20 700	1 280	239/950R	239/950RK	986	1 214	6	0.16	4.15	6.18	4.06	755	731
	1 360	300	7.5	14 400	27 700	1 610	230/950R	230/950RK	986	1 324	6	0.21	3.20	4.77	3.13	1 470	1 420
	1 360	412	7.5	19 800	41 000	1 910	240/950RHA	240/950RHAK	986	1 324	8	0.27	2.51	3.74	2.46	1 980	1 950
1 000	1 220	165	6	5 820	13 600	947	238/1000R	238/1000RK	1 028	1 192	5	0.12	5.65	8.42	5.53	410	396
	1 320	236	7.5	10 300	21 500	1 320	239/1000R	239/1000RK	1 036	1 284	6	0.16	4.14	6.16	4.05	895	866
	1 420	308	7.5	15 400	30 000	1 740	230/1000R	230/1000RK	1 036	1 384	6	0.21	3.26	4.85	3.18	1 620	1 570
	1 420	412	7.5	20 300	41 800	1 810	240/1000R	240/1000RK30	1 036	1 384	6	0.26	2.57	3.82	2.51	2 120	2 090
1 060	1 280	165	6	6 080	14 500	1 010	238/1060R	238/1060RK	1 088	1 252	5	0.11	6.33	9.42	6.19	435	420
	1 400	250	7.5	11 900	25 300	1 540	239/1060R	239/1060RK	1 096	1 364	6	0.16	4.14	6.17	4.05	1 040	1 010
	1 500	438	9.5	21 400	43 800	1 900	240/1060R	240/1060RK30	1 104	1 456	8	0.27	2.51	3.74	2.46	2 490	2 450
1 120	1 460	250	7.5	12 400	26 600	1 640	239/1120R	239/1120RK	1 156	1 424	6	0.16	4.34	6.47	4.25	1 150	1 110
	1 580	345	9.5	19 000	37 200	2 090	230/1120R	230/1120RK	1 164	1 536	8	0.21	3.28	4.88	3.21	2 190	2 120
	1 580	462	9.5	23 900	49 400	2 100	240/1120R	240/1120RK30	1 164	1 536	8	0.28	2.45	3.65	2.40	2 900	2 860
1 180	1 540	272	7.5	13 600	29 800	1 730	239/1180R	239/1180RK	1 216	1 504	6	0.16	4.22	6.29	4.13	1 330	1 280
1 250	1 630	280	7.5	15 200	33 800	1 970	239/1250R	239/1250RK	1 286	1 594	6	0.16	4.31	6.41	4.21	1 600	1 550
1 400	1 820	315	9.5	18 300	41 400	2 340	239/1400R	239/1400RK	1 444	1 776	8	0.16	4.32	6.43	4.22	2 230	2 160

[Remark] For bearings with lubrication holes and lubrication grooves on the outer ring, refer to page 371 and 372.

Thrust ball bearings

■ Single direction

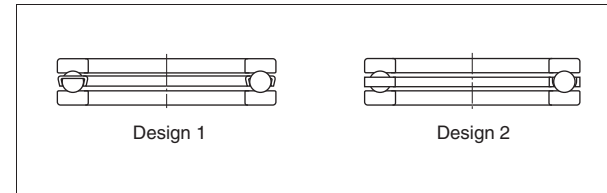

- Axial load can be accommodated in one direction.
- Although it is designed to carry high axial load, is not suitable for high-speed operation.
- The rolling elements normally contacts the shaft washer (or housing washer) with contact angle 90°.

Boundary dimensions	As specified in JIS B 1512.
Tolerances	As specified in JIS B 1514, class 0 or 6. (refer to Table 2-7 on page 30.)
Allowable misalignment	Misalignment not allowed.
Amount of preload for thrust ball bearings	<p>When a thrust ball bearing is rotated at high speed, balls slide on raceway due to centrifugal force and the gyro moment, which often causes the raceway to suffer from smearing or other defects.</p> <p>To eliminate such sliding, it is necessary to mount the bearing without clearance, and apply an axial load (preload) larger than the minimum necessary axial load determined by the following equation.</p> $F_{a \min} = 5.1 \left[\frac{n}{1\ 000} \right]^2 \cdot \left[\frac{C_{0a}}{1\ 000} \right]^2 \times 10^{-3} \dots\dots (\text{contact angle : } 90^\circ)$ <p>where :</p> <p>$F_{a \min}$: minimum necessary axial load N</p> <p>n : rotational speed min⁻¹</p> <p>C_{0a} : static axial load rating N</p> <p>When an axial load from the outside is lower than 0.001 3 C_{0a}, there is no adverse effect on the bearing, as long as lubrication is satisfactory.</p> <p>Generally, deep groove and angular contact ball bearings are recommended for applications when a portion of rotation under axial load is present at high speed.</p>
Standard cages	Pressed cage (Design 1) or machined cage (Design 2)
Equivalent axial load	<p>Dynamic equivalent axial load $P_a = F_a$</p> <p>Static equivalent axial load $P_{0a} = F_a$</p>



Single direction thrust ball bearings

d 100 ~ (160) mm

d (160) ~ (320) mm

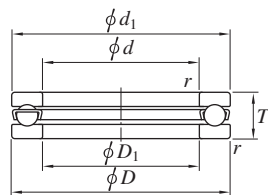

Design 1



Design 2

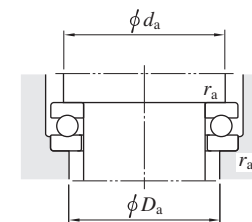

Boundary dimensions (mm)				Basic load ratings (kN)		Fatigue load limit (kN)	Bearing No.	De-sign	Dimensions (mm)		Mounting dimensions (mm)			(Refer.) Mass (kg)
d	D	T	$r_{min.}$	C_a	C_{0a}	C_u			d_1 max.	D_1 min.	d_a min.	D_a max.	r_a max.	
100	135	25	1	106	268	11.2	51120	1	135	102	121	114	1	0.990
	150	38	1.1	183	410	16.6	51220	1	150	103	130	120	1	2.36
	170	55	1.5	296	595	23.2	51320	1	170	103	142	128	1.5	5.11
	210	85	3	460	983	35.7	51420	2	205	103	165	145	2.5	14.6
110	145	25	1	109	288	11.5	51122	1	145	112	131	124	1	1.08
	160	38	1.1	191	450	17.6	51222	1	160	113	140	130	1	2.57
	190	63	2	334	704	25.9	51322	2	187	113	158	142	2	7.72
	230	95	3	474	1 070	37.1	51422	2	225	113	181	159	2.5	19.8
120	155	25	1	111	305	11.9	51124	1	155	122	141	134	1	1.16
	170	39	1.1	192	470	17.7	51224	1	170	123	150	140	1	2.86
	210	70	2.1	389	869	30.5	51324	2	205	123	173	157	2	10.6
	250	102	4	601	1 460	48.5	51424	2	245	123	196	174	3	25.0
130	170	30	1	130	350	13.0	51126	1	170	132	154	146	1	1.87
	190	45	1.5	254	620	22.2	51226	1	187	133	166	154	1.5	4.09
	225	75	2.1	413	958	32.5	51326	2	220	134	186	169	2	13.0
	270	110	4	623	1 540	49.0	51426	2	265	134	212	188	3	31.4
140	180	31	1	133	375	13.5	51128	1	178	142	164	156	1	2.02
	200	46	1.5	234	650	19.6	51228	1	197	143	176	164	1.5	4.46
	240	80	2.1	458	1 130	36.9	51328	1	235	144	199	181	2	15.5
	280	112	4	650	1 680	52.2	51428	2	275	144	222	198	3	33.9
150	190	31	1	137	400	13.9	51130	1	188	152	174	166	1	2.15
	215	50	1.5	266	652	21.8	51230	2	212	153	189	176	1.5	5.64
	250	80	2.1	451	1 130	36.0	51330	2	245	154	209	191	2	16.3
	300	120	4	711	1 910	57.4	51430	2	295	154	238	212	3	41.6
160	200	31	1	140	425	14.4	51132	1	198	162	184	176	1	2.28
	225	51	1.5	279	718	23.4	51232	2	222	163	199	186	1.5	6.53

Boundary dimensions (mm)				Basic load ratings (kN)		Fatigue load limit (kN)	Bearing No.	De-sign	Dimensions (mm)		Mounting dimensions (mm)			(Refer.) Mass (kg)
d	D	T	$r_{min.}$	C_a	C_{0a}	C_u			d_1 max.	D_1 min.	d_a min.	D_a max.	r_a max.	
160	270	87	3	512	1 340	41.3	51332	2	265	164	225	205	2.5	21.0
	320	130	5	852	2 410	70.3	51432	2	315	164	254	226	4	51.2
170	215	34	1.1	168	510	16.7	51134	1	213	172	197	188	1	3.25
	240	55	1.5	326	834	26.3	51234	2	237	173	212	198	1.5	8.12
	280	87	3	579	1 570	47.4	51334	2	275	174	235	215	2.5	22.0
	340	135	5	943	2 730	77.2	51434	2	335	174	270	240	4	60.0
180	225	34	1.1	168	525	16.7	51136	1	222	183	207	198	1	3.39
	250	56	1.5	332	874	26.9	51236	2	247	183	222	208	1.5	8.68
	300	95	3	578	1 580	46.2	51336	2	295	184	251	229	2.5	28.1
190	240	37	1.1	213	655	20.2	51138	1	237	193	220	210	1	3.95
	270	62	2	385	1 060	31.4	51238	2	267	194	238	222	2	11.7
	320	105	4	679	1 950	55.3	51338	2	315	195	266	244	3	36.0
200	250	37	1.1	215	675	20.4	51140	1	247	203	230	220	1	4.13
	280	62	2	392	1 110	32.2	51240	2	277	204	248	232	2	12.2
	340	110	4	745	2 220	61.1	51340	2	335	205	282	258	3	42.9
220	270	37	1.1	221	740	21.3	51144	1	267	223	250	240	1	4.50
	300	63	2	428	1 310	36.6	51244	2	297	224	268	252	2	13.5
240	300	45	1.5	301	1 020	28.0	51148	2	297	243	276	264	1.5	7.38
	340	78	2.1	553	1 800	47.8	51248	2	335	244	299	281	2	23.1
260	320	45	1.5	289	990	26.2	51152	2	317	263	296	284	1.5	7.93
	360	79	2.1	556	1 880	48.1	51252	2	355	264	319	301	2	25.0
280	350	53	1.5	411	1 430	36.4	51156	2	347	283	322	308	1.5	12.0
300	380	62	2	454	1 610	39.4	51160	2	376	304	348	332	2	17.5
	420	95	3	713	2 600	61.9	51260	2	415	304	371	349	2.5	42.5
320	400	63	2	474	1 760	41.9	51164	2	396	324	368	352	2	19.0

Single direction thrust ball bearings

d (320) ~ 530 mm

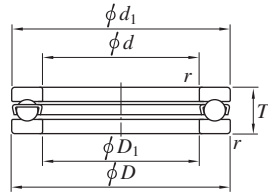

Design 1



Design 2

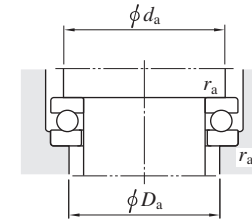

Boundary dimensions (mm)				Basic load ratings (kN)		Fatigue load limit (kN)	Bearing No.	De-sign	Dimensions (mm)		Mounting dimensions (mm)			(Refer.) Mass (kg)
d	D	T	r min.	C_a	C_{0a}	C_u			d_1 max.	D_1 min.	d_a min.	D_a max.	r_a max.	
320	440	95	3	721	2 710	62.9	51264	2	435	325	391	369	2.5	45.0
	460	96	3	730	2 830	63.8								
340	420	64	2	483	1 860	43.1	51168	2	416	344	388	372	2	20.5
	460	96	3	730	2 830	63.8								
360	440	65	2	493	1 960	44.3	51172	2	436	364	408	392	2	21.5
	500	110	4	876	3 500	76.1								
380	460	65	2	494	2 010	44.3	51176	2	456	384	428	412	2	23.0
	520	112	4	889	3 650	77.8								
400	480	65	2	503	2 110	45.4	51180	2	476	404	448	432	2	24.0
	540	112	4	903	3 810	79.4								
420	500	65	2	512	2 210	46.6	51184	2	495	424	468	452	2	25.0
	580	130	5	1 020	4 420	89.4								
440	540	80	2.1	652	2 930	59.7	51188	2	535	444	499	481	2	41.5
	600	130	5	1 040	4 620	91.6								
460	560	80	2.1	633	2 850	57.1	51192	2	555	464	519	501	2	43.0
	620	130	5	1 060	4 830	93.8								
480	580	80	2.1	570	2 610	51.1	51196	2	575	484	539	521	2	44.0
500	600	80	2.1	683	3 300	63.6	511/500	2	595	505	559	541	2	46.0
530	640	85	3	729	3 570	66.8	511/530	2	635	535	595	575	2.5	57.5

Tapered roller thrust bearings



- Tapered roller thrust bearings come in three types, single direction type, double direction type, and screw-down spindle type (single direction full complement type). They are suitable for extremely heavy axial load and impact load.
- The housing washer and shaft washer raceways are so designed that the extension lines of both raceways intersect at one point on the bearing centerline axis which promotes geometrically true rolling motion of the rolling elements.
- The contact areas between the rib provided for shaft washer and/or housing washer and the spherically ground roller large end face are designed so that the rollers can be guided securely, and proper oil film is formed.

■ Single direction (page 410)

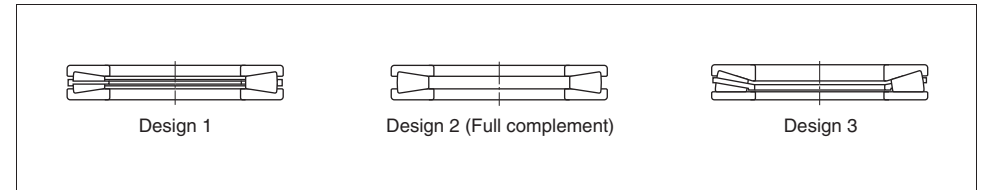

- Bearings having ribs for both shaft and housing washers are suitable for the locations where the bearings can be securely fixed in radial direction, and mainly used for crane hook and swivel of oil excavator.
- If extremely heavy axial load is required, use the full complement type bearings (Design 2).
- Bearings having flat housing washer raceway (Design 3) allow some misalignment of shaft (against housing hole) during rotation.

■ Double direction (page 414)

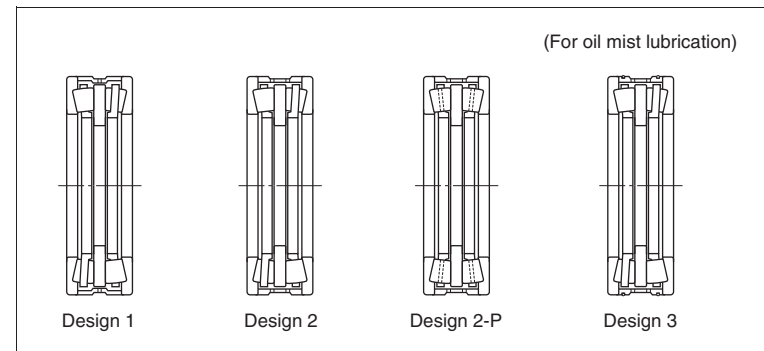

- The bearing of this type can support axial load in both directions, and is mainly used to support the axial load on roll neck of rolling mills.
- Since the shaft washer is treated with a clearance fit to the shaft, the shaft washer must be tightened and fixed securely with a sleeve.
- The axial clearance is commonly adjusted by means of spacer. The bearing without spacer is pre-loaded by spring, etc. for use.
- Some bearings have lubrication holes and O-rings on the spacer for oil mist lubrication.

■ For screw down spindles (Single direction full complement)

THR ... Type (page 418)

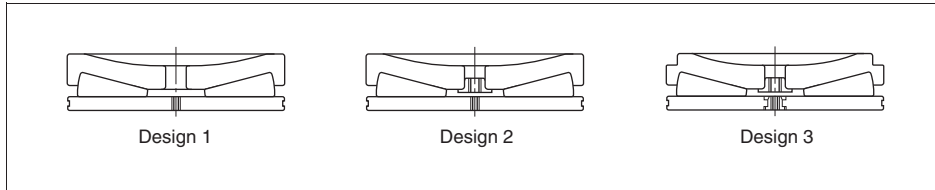

THR ... X Type (page 420)



- The bearings, suitable for low-speed and heavy load, have been designed for screw down spindles.
- The shaft washer surface is ground to convex or concave spherical surface to suit the profiles of the shaft end faces of screw-down spindles.
- Since the spherical shaft washer surface supports screw-down spindles, some misalignment of screw-down spindles during rotation is allowable. Some spindle runout is also allowable, since the housing washer raceway is designed flat.

- The bearings can be handled easily, as the shaft washer has the lifting hole in the center (some bearings have lifting nuts in the lifting holes: Design 2, 3, 5), and the housing washer also has lifting tapped hole.
- In many cases, housing washer is fixed to the housing with full dog point set screws. Thus, the outside surface is equipped with a groove to receive the tip of the set screws.

Boundary dimensions	Custom-manufactured to dimensions required for specific equipment.
Tolerances	Consult with JTEKT, as special tolerances are adopted for specific application. Generally equivalent to class 0 specified in JIS (refer to Table 2-8 on page 31).
Misalignment	No misalignment is allowable.
Standard cage	Machined cage
Equivalent load	Dynamic equivalent load $P_a = F_a$ Static equivalent load $P_{0a} = F_a$

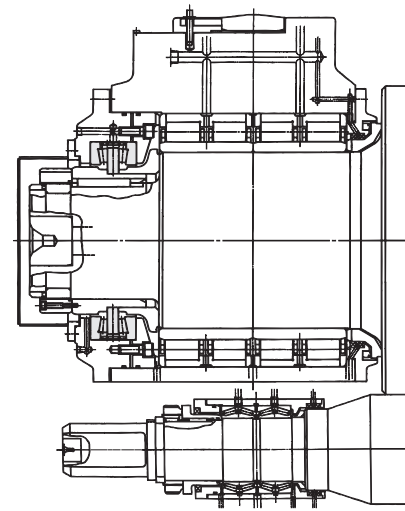

Mounting example of double direction tapered roller thrust bearing on the rolling mill roll neck

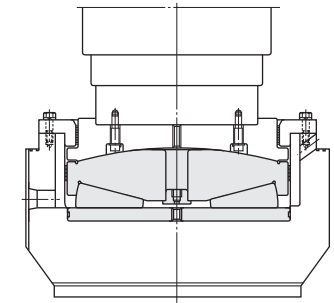

Mounting example of tapered roller thrust bearing for screw down spindle

Single direction tapered roller thrust bearings

d 114.3 ~ 340 mm

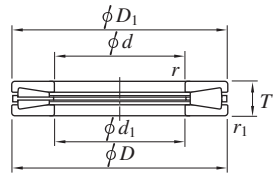

Design 1



Design 1-1

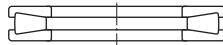

Design 2

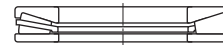

Design 3

Boundary dimensions										Basic load ratings (kN)		Fatigue load limit (kN) C_u	Bearing No.	Design	Max. fillet radius (mm)		Mass (kg)
d mm	D mm	T mm	D_1 mm	d_1 mm	$r^{1)}$	$r_1^{1)}$	C_a	C_{0a}	Shaft r_a	Housing r_b							
114.3	250	53.975	250	114.3	4	4	1 200	3 960	333	THR2325	1	—	—	14.0			
115	280	70	280	117	6	6	1 620	5 160	413	T232807	1	—	—	24.0			
152.400	317.500	69.850	317.500	152.400	6.4	6.4	1 900	6 530	520	T611	1	4	4	31.0			
152.4	317.5	69.85	317.5	152.7	6.4	6.4	1 880	6 290	501	THR303207A	3	—	—	29.0			
174.625	358.775	82.550	358.775	174.625	6.4	6.4	2 440	8 570	644	T691	1	4	4	45.0			
	358.775	82.550	358.775	174.625	6.4	6.4	3 060	11 600	850	T691V	2	4	4	46.0			
177.800	368.300	82.550	368.300	177.800	7.9	7.9	2 580	9 150	677	T711	1	5	5	48.0			
180	360	109	358	190	6	6	2 810	7 690	627	THR363611	3	—	—	47.0			
203.200	419.100	92.075	419.100	203.200	9.5	9.5	3 240	11 600	839	T811	1	6	6	69.0			
203.2	419.1	92.075	416.7	203.2	9.5	9.5	3 200	11 200	810	THR404292	3	—	—	68.0			
228.600	482.600	104.775	482.600	228.600	SP	11.2	4 240	16 300	1 080	T911	1-1	7	7	107			
234.950	546.100	127.000	546.100	234.950	15.9	15.9	6 950	28 400	1 740	T921V	2	11	11	175			
241	404	110	404	241	5	5	2 750	8 140	656	THR484011	3	3	3	62.0			
254	539.75	117.48	539.75	254	11.1	11.1	5 170	20 200	1 290	THR515412	3	—	—	143			
279.400	603.250	136.520	603.250	279.400	SP	11.1	6 900	26 800	1 680	T1120	1-1	7	7	210			
	603.250	136.520	603.250	279.700	11.1	11.1	8 910	37 900	2 220	T1120V	2	7	7	220			
290	395	80	395	291	SP	SP	1 500	4 780	412	THR584008	3	2.5	2.5	30.0			
300	663.5	165	658	306	12	12	7 970	30 000	1 810	THR6066	3	—	—	312			
340	460	96	460	340	4	4	1 890	6 960	555	THR684610	3	—	—	53.6			

[Note] 1) SP indicates the specially chamfered form.

Single direction tapered roller thrust bearings

d 406.4 ~ 830 mm

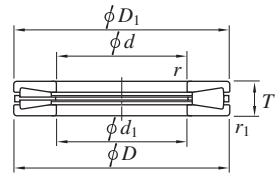

Design 1



Design 1-1

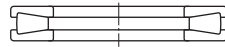

Design 2

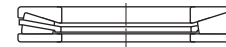

Design 3

Boundary dimensions									Basic load ratings (kN)		Fatigue load limit (kN) C_u	Bearing No.	Design	Max. fillet radius (mm)		Mass (kg)
d mm	D mm	T mm	D_1 mm	d_1 mm	$r^{1)}$ mm	$r_1^{1)}$ mm	C_a	C_{0a}	Shaft r_a	Housing r_b						
406.4	711.2	146.05	711.2	406.4	SP	9.7	8 090	32 500	2 050	T16021	1-1	—	—	256		
609.6	812.8	101.6	812.8	609.6	SP	SP	5 500	27 300	1 760	THR610	3	—	—	152		
749.3	955.975	127	952.5	749.8	5.1	5.1	6 990	30 500	1 980	THR749	3	2	2	230		
830	1 010	80	1 010	830	5	5	3 490	20 300	1 240	THR830	1	—	—	136		

[Note] 1) SP indicates the specially chamfered form.

Double direction tapered roller thrust bearings

d 160 ~ (420) mm

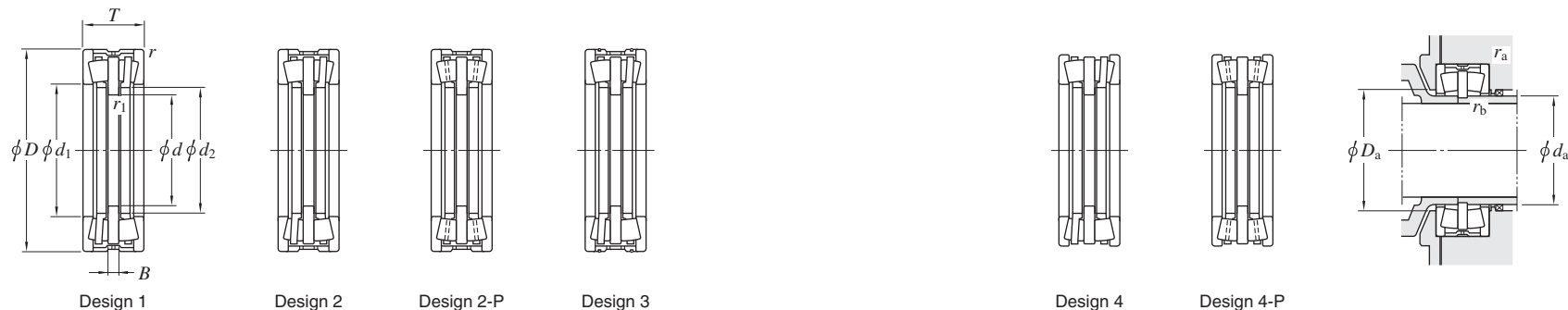

Boundary dimensions (mm)								Basic load ratings (kN)		Fatigue load limit (kN)	Bearing No.	Design	Mounting dimensions (mm)				Mass (kg)
d	D	T	B	d_1	d_2	r	r_1	C_a	C_{0a}	C_u			d_a min.	D_a max.	r_a max.	r_b max.	
160	280	130	50	190	190	2	1.5	823	2 950	286	2THR322813	1	184	196	1	1	33.0
170	240	84	20	184	182	4	1.5	402	1 310	133	2THR342408A	2	179	192	2.5	0.8	12.0
	240	84	20	184	182	4	1.5	420	1 400	142	2THR342408B	2	176	190	3	1	12.0
180	280	90	20	210	205	2	1	800	2 710	250	2THR362809A	4	199	216	1	0.5	19.0
	400	200	50	210	210	3	1	3 060	9 620	729	2THR364020	2	204	216	2	0.5	130
200	430	231	100	260	254	4	1.5	2 410	9 470	722	2THR404323-2	2	245	266	3	1	170
220	300	96	26	240	232	2	1	677	2 350	225	2THR443010	1	226	246	1	0.5	19.0
	300	96	22	240	232	2	1	677	2 350	225	2THR443010A	1	226	246	1	0.5	18.0
	340	130	39	250	245.6	2	1	1 150	3 870	344	2THR443413	4	239.6	256	1	0.5	40.0
	372	195	75	254	246	4	1.5	1 890	6 280	511	2THR443720	4	240	260	3	1	85.0
250	380	100	22	275	270	2	1.1	1 130	4 840	389	2THR503810C	1	264	281	1	0.5	40.0
260	360	92	20	285	276	2	1	904	3 630	330	2THR52369	2	270	291	1	0.5	25.0
	360	92	20	285	276	2	1	904	3 630	330	2THR52369/DP	3	270	291	1	0.5	25.0
291	520	266	118	349	349	12	2	2 660	10 800	811	2THR585227	2	343	357	10.5	1.5	245
320	470	130	30	350	340	3	1	1 640	6 080	498	2THR644713	2	334	358	1.5	0.5	70.0
350	490	130	30	390	380	3	1	1 610	6 200	503	2THR704913A	1	374	398	1.5	0.5	70.0
	490	130	30	390	380	3	1	1 610	6 200	503	2THR704913A/DP	3	374	398	1.5	0.5	70.0
	490	130	30	390	380	4	2	1 610	6 200	503	2THR704913A/DP1	3	375	398	2.5	1	70.0
351	670	308	120	435	430	12	3	4 330	19 500	1 320	2THR706731	1	424	443	10	2	505
	670	319	131	435	430	12	3	4 330	19 500	1 320	2THR706732	1	424	443	10	2	505
380	560	130	32	430	416	3	1.5	1 960	8 860	660	2THR765613	2	410	438	1.5	0.5	110
	560	130	32	430	416	3	1.5	1 960	8 860	660	2THR765613A	3	410	438	1.5	0.5	110
	560	130	32	430	416	4	2.5	1 960	8 860	660	2THR765613A/DP	3	410	438	2.5	1.5	100
420	620	170	35	465	455	3	1.5	3 220	14 000	1 030	2THR846217	2-P	449	473	1.5	0.5	160

Double direction tapered roller thrust bearings

d (420) ~ 550 mm

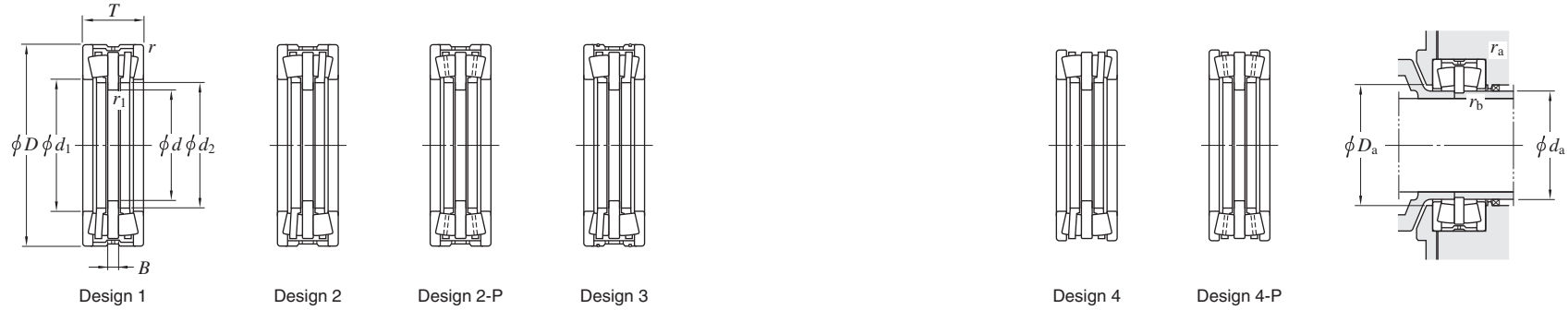

Boundary dimensions (mm)								Basic load ratings (kN)		Fatigue load limit (kN)	Bearing No.	Design	Mounting dimensions (mm)				Mass (kg)
d	D	T	B	d_1	d_2	r	r_1	C_a	C_{0a}	C_u			d_a min.	D_a max.	r_a max.	r_b max.	
420	650	235	85	496	486	4	1.5	3 460	14 500	1 040	2THR846524	2-P	480	504	2	1	260
440	650	240	90	492.5	485	7	1.5	3 590	15 200	1 070	2THR886524	4	479	502	5	0.5	270
470	720	200	40	535	516	5	3	4 370	19 700	1 380	2THR947220	2-P	508	545	3	2	270
482	680	250	90	535	524	7	2	3 860	16 000	1 140	2THR966825	4-P	516	545	5	1	280
520	860	382	168	625	610	20	2	6 530	32 800	2 080	2THR520	2-P	602	635	15	1	850
550	760	230	50	610	590	5	2	3 630	15 000	1 080	2THR550	2-P	580	622	3	1	290

Tapered roller thrust bearings for screw down spindle

THR...X type (Full complement)

D 149.225 ~ 520.000 mm

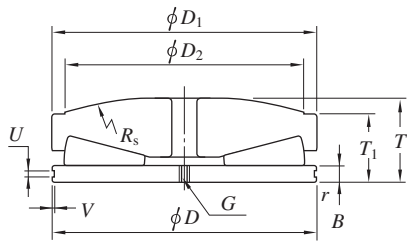

Design 1

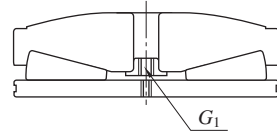

Design 2

Boundary dimensions					Basic load ratings		Bearing No.	Design	Dimensions (mm)							Mass (kg)			
D	D ₁	D ₂	T	r	C _{0a}	B			T ₁	R _s	U	V	G	G ₁					
mm	1/25.4	mm	1/25.4	mm	1/25.4	mm	1/25.4	mm	mm	mm	mm	mm	mm	mm	mm	mm	mm		
149.225	5.8750	146.863	5.7820	127.0	5.0000	54.528	2.1468	1.6	2 190	THR149X	1	12.700	47.625	457.2	4.8	1.2	M12	—	6.00
174.625	6.8750	172.263	6.7820	152.4	6.0000	60.702	2.3898	1.6	2 860	THR175X	2	12.700	52.375	457.2	4.8	1.2	M12	M16	10.0
	6.8750	172.263	6.7820	152.4	6.0000	61.001	2.4016	1.6	2 860	THR175X-1	1	12.700	52.388	800.0	4.8	1.2	W 1/2	—	10.0
	6.8750	174.549	6.8720	152.4	6.0000	60.708	2.3901	1.6	2 860	THR175X-2	2	12.700	52.375	457.0	4.8	1.2	M12	M16	10.0
203.200	8.0000	200.838	7.9070	177.8	7.0000	74.729	2.9421	1.6	3 970	THR203X	1	15.875	65.075	508.0	6.35	1.2	M12	—	16.0
	8.0000	200.838	7.9070	177.8	7.0000	74.729	2.9421	1.6	3 970	THR203X-1	2	15.875	65.075	508.0	6.35	1.2	M12	M8	16.0
266.700	10.5000	264.338	10.4070	228.6	9.0000	93.491	3.6807	1.6	7 730	THR267X	1	19.050	80.963	609.6	7.9	2.0	M20	—	35.0
	10.5000	264.338	10.4070	228.6	9.0000	93.491	3.6807	1.6	7 730	THR267X-2	2	19.050	80.963	609.6	7.9	2	M20	M30	35.0
275.000	10.8288	270.000	10.6299	234.0	9.2126	98.994	3.8974	3.0	4 250	THR275X	1	20.000	85.000	609.6	—	—	—	—	40.0
320.675	12.6250	318.313	12.5320	279.4	11.0000	109.922	4.3276	1.6	11 700	THR321AX	2	22.225	95.250	762.0	10.3	2.4	M36	M42	60.0
	12.6250	318.313	12.5320	279.4	11.0000	109.922	4.3276	1.6	11 700	THR321BX	2	22.225	95.250	762.0	—	—	M36	M42	60.0
	12.6250	318.313	12.5320	279.4	11.0000	110.382	4.3457	1.6	11 700	THR321X	1	22.225	95.250	762.0	10.3	2.4	M20	—	60.0
377.825	14.8750	375.463	14.7820	330.2	13.0000	127.639	5.0252	1.6	15 600	THR378X	2	25.400	111.125	914.4	10.3	2.4	M24	M42	95.0
409.575	16.1250	407.213	16.0320	355.6	14.0000	139.979	5.5110	3.2	18 700	THR410X	2	28.575	122.225	1 016.0	10.3	2.4	M24	M30	120
438.150	17.2500	435.788	17.1570	381.0	15.0000	149.442	5.8835	3.2	21 500	THR438X	2	31.750	130.175	1 016.0	13.5	3.2	M12	M24	150
	17.2500	435.788	17.1570	381.0	15.0000	149.882	5.9009	3.2	21 500	THR438X-4	2	31.750	130.175	1 066.8	—	—	M12	M24	150
482.600	19.0000	480.210	18.9059	432.0	17.0079	144.065	5.6719	3.2	24 600	THR483XC	2	38.100	130.180	1 905.0	13.5	3.2	M24	M30	180
490.220	19.3000	492.938	19.4070	431.8	17.0000	169.440	6.6709	3.2	28 000	THR495X-1	1	34.925	146.050	1 066.8	12.7	3.2	M24	—	220
	19.3000	492.938	19.4070	431.8	17.0000	169.440	6.6709	3.2	28 000	THR495X-2	2	34.925	146.050	1 066.8	12.7	3.2	M24	M30	220
495.300	19.5000	492.938	19.4070	431.8	17.0000	169.440	6.6709	3.2	28 000	THR495X	1	34.925	146.050	1 066.8	13.5	3.3	M24	—	220
	19.5000	492.938	19.4070	431.8	17.0000	169.440	6.6709	3.3	28 000	THR495X-3	2	34.925	146.050	1 066.8	13.5	3.3	M24	M30	240
514.350	20.2500	521.386	20.5270	403.2	15.8740	188.712	7.4296	1.6	32 700	THR521X	2	34.925	154.813	635.0	—	—	W1	W1-1/4	250
520.000	20.4724	521.513	20.5320	457.2	18.0000	174.783	6.8812	3.2	32 700	THR524X-1	1	34.925	152.400	1 270.0	12.7	3.2	M24	—	250

Tapered roller thrust bearings for screw down spindle

THR...X type (Full complement)

D 523.875 ~ 900.000 mm

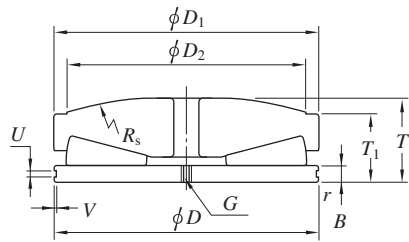

Design 1

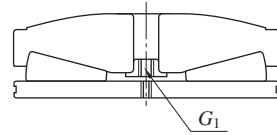

Design 2

Boundary dimensions					Basic load ratings (kN)		Design	Dimensions (mm)							Mass (kg)				
D	D ₁	D ₂	T	r	C _{0a}	Bearing No.		B	T ₁	R _s	U	V	G	G ₁					
mm	1/25.4	mm	1/25.4	mm	1/25.4	mm	1/25.4	mm	mm	mm	mm	mm	mm	mm					
523.875	20.6250	521.513	20.5320	457.2	18.0000	174.783	6.8812	3.2	32 700	THR524X	1	34.925	152.400	1 270.0	13.5	3.2	M24	—	250
533.400	21.0000	531.010	20.9059	457.2	18.0000	177.169	6.9752	1.6	32 700	THR533X	2	31.750	161.920	1 981.2	9.5	6	M24	M36	270
555.625	21.8750	553.260	21.7819	482.6	19.0000	189.438	7.4582	3.2	36 300	THR556AX	2	38.100	165.100	1 295.4	12.7	3.2	1-8UNC	1*1/4-7UNC	305
	21.8750	553.260	21.7819	482.6	19.0000	189.438	7.4582	3.2	36 300	THR556BX	2	38.100	165.100	1 270	—	—	M24	M36	310
	21.8750	553.260	21.7819	482.6	19.0000	189.438	7.4582	3.2	36 300	THR556D-2X	2	38.100	165.100	1 270	11	6.7	M24	M36	320
	21.8750	553.260	21.7819	482.6	19.0000	189.438	7.4582	3.2	36 300	THR556X-1	2	38.100	165.100	1 295.4	12.7	3.2	M24	M36	305
581.025	22.8750	578.663	22.7820	508.0	20.0000	192.511	7.5792	3.2	38 400	THR581X	2	38.100	168.275	1 422.4	13.5	3.2	M24	M42	340
	22.8750	578.663	22.7820	508.0	20.0000	196.650	7.7421	3.2	38 400	THR581X-3	2	38.100	168.275	1 308.1	13.5	3.2	M24	M42	350
609.600	24.0000	607.238	23.9070	533.4	21.0000	202.831	7.9855	3.2	44 600	THR610X	2	38.100	177.800	1 524.0	13.5	3.2	M24	M30	390
	24.0000	607.238	23.9070	533.4	21.0000	202.831	7.9855	3.2	44 600	THR610X-1	2	38.100	177.800	1 524.0	13.5	3.2	M30	M42	390
641.350	25.2500	638.988	25.1570	553.8	21.8031	211.492	8.3265	3.2	49 400	THR641X	2	38.100	184.150	1 524.0	13.5	3.2	M24	M30	450
	25.2500	638.988	25.1570	558.8	22.0000	211.854	8.3407	3	49 400	THR641CX	2	38.100	184.150	1 524.0	—	—	M24	M42	460
710.000	27.9528	710.000	27.9528	630.0	24.8031	259.107	10.2011	3.5	54 900	THR710XA	2	40.000	200.000	1 400.0	—	—	M24	M48	680
800.000	31.4961	798.000	31.4173	720.0	28.3465	260.268	10.2468	5	71 800	THR800X	2	50.000	214.000	1 524.0	—	—	M30	M30	870
	31.4961	840.000	33.0709	740.0	29.1339	265.000	10.4331	7	77 800	THR840X	2	50.000	221.000	1 800.0	—	—	M36	M48	940
847.600	33.3701	841.000	33.1102	650.0	25.5906	248.000	9.7638	5	77 800	THR848X	2	43.000	212.000	1 652.0	—	—	M42	M42	930
	33.3701	841.000	33.1102	650.0	25.5906	248.000	9.7638	5	77 800	THR848X-1	2	43.000	212.000	1 652.0	—	—	M36	M42	890
900.000	35.4331	900.000	35.4331	870.0	34.2520	228.739	9.0055	2	81 100	THR900X	2	40.000	177.840	1 800.0	11.0	7.5	M24	M48	970
	35.4331	930.000	36.6142	820.0	32.2835	275.000	10.8268	5	98 200	THR930XB	2	60.000	223.000	1 800.0	—	—	M36	M48	1 170

Spherical thrust roller bearings

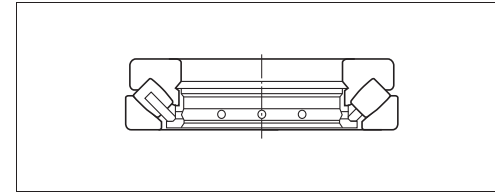

- Spherical thrust roller bearings are designed to carry high axial loads. They can also support radial load if magnitude is no more than 55 % of the axial load being carried.
- Having a spherical housing washer raceway surface, these bearings are self-alignings.
- These bearings are not suitable for high-speed rotation. In general, they are used with oil lubrication.

Boundary dimensions	As specified in JIS B 1512.
Tolerances	As specified in JIS B 1514, class 0. (refer to Table 2-8 on page 31.)
Allowable aligning angle	0.035 – 0.052 rad (2° – 3°) in general, depending on bearing series.
Amount of preload for spherical thrust roller bearings	<p>Spherical thrust roller bearings sometimes suffer from scuffing, smearing, or other defects due to sliding which occurs between the roller and raceway surface under normal operation.</p> <p>To eliminate such sliding, it is necessary to mount the bearing without clearance, and apply an axial load (preload) larger than the minimum necessary axial load determined by the following equation. (the higher value determined by the two equations should be taken)</p> $F_{a \min} = \frac{C_{0a}}{2\,000}$ $F_{a \min} = 1.8F_r + 1.33 \left[\frac{n}{1\,000} \right]^2 \cdot \left[\frac{C_{0a}}{1\,000} \right]^2 \times 10^{-4}$ <p>where :</p> <ul style="list-style-type: none"> $F_{a \min}$: minimum necessary axial load N F_r : radial load N n : rotational speed min⁻¹ C_{0a} : static axial load rating N
Standard cage	Machined cage
Equivalent axial load	<p>Dynamic equivalent axial load $P_a = 1.2 F_r + F_a$</p> <p>Static equivalent axial load $P_{0a} \cong 2.7 F_r + F_a$ (Note : $F_r / F_a \leq 0.55$)</p>



Spherical thrust roller bearings

d 100 ~ (220) mm

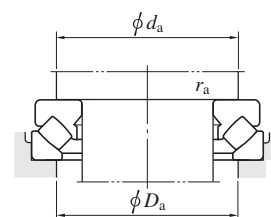
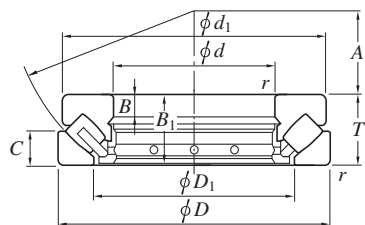

Boundary dimensions (mm)				Basic load ratings (kN)		Fatigue load limit (kN)	Bearing No.	Dimensions (mm)						Mounting dimensions (mm)			(Refer.) Mass (kg)
d	D	T	$r_{min.}$	C_a	C_{0a}	C_u		d_1	D_1	B	B_1	C	A	d_a min.	D_a max.	r_a max.	Mass
100	170	42	1.5	481	1 270	118	29320R 29420R	163	129	14	40	20.8	58	130	150	1.5	3.91
	210	67	3	911	2 220	166		200	146	24	64	32	62	150	175	2.5	11.2
110	190	48	2	628	1 690	147	29322R 29422R	182	143	16	45.5	23	64	145	165	2	5.67
	230	73	3	1 120	2 810	203		220	162	26	69	35	69	165	190	2.5	14.7
120	210	54	2.1	759	2 030	182	29324R 29424R	200	159	18	51	26	70	160	180	2	7.90
	250	78	4	1 300	3 270	241		236	174	29	74	37	74	180	205	3	18.5
130	225	58	2.1	894	2 440	209	29326R 29426R	215	171	19	55	28	76	170	195	2	9.45
	270	85	4	1 490	3 870	270		255	189	31	81	41	81	195	225	3	23.5
140	240	60	2.1	898	2 470	206	29328R 29428R	230	183	20	57	29	82	185	205	2	11.1
	280	85	4	1 560	4 080	289		268	199	31	81	41	86	205	235	3	24.8
150	250	60	2.1	965	2 740	233	29330R 29430R	240	194	20	57	29	87	195	215	2	11.7
	300	90	4	1 730	4 620	334		285	214	32	86	44	92	220	250	3	28.3
160	270	67	3	1 150	3 280	272	29332R 29432R	260	208	23	64	32	92	210	235	2.5	15.6
	320	95	5	1 990	5 370	375		306	229	34	91	45	99	230	265	4	36.3
170	280	67	3	1 190	3 450	286	29334R 29434R	270	216	23	64	32	96	220	245	2.5	16.3
	340	103	5	2 120	5 880	389		324	243	37	99	50	104	245	285	4	44.2
180	300	73	3	1 380	4 000	330	29336R 29436R	290	232	25	69	35	103	235	260	2.5	20.7
	360	109	5	2 450	6 590	447		342	255	39	105	52	110	260	300	4	52.1
190	320	78	4	1 570	4 610	369	29338R 29438R	308	246	27	74	38	110	250	275	3	25.4
	380	115	5	2 790	7 690	504		360	271	41	111	55	117	275	320	4	61.4
200	280	48	2	641	2 270	151	29240	271	236	15	45	24	108	235	255	2	8.90
	340	85	4	1 810	5 340	415	29340R	325	261	29	81	41	116	265	295	3	31.5
	400	122	5	3 060	8 470	575	29440R	380	286	43	117	59	122	290	335	4	72.1
220	300	48	2	670	2 340	148	29244	292	254	15	45	24	117	260	275	2	9.5
	360	85	4	1 840	5 590	439	29344R	345	280	29	81	41	125	285	315	3	33.8

Spherical thrust roller bearings

d (220) ~ (400) mm

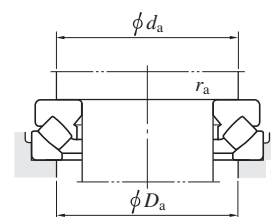
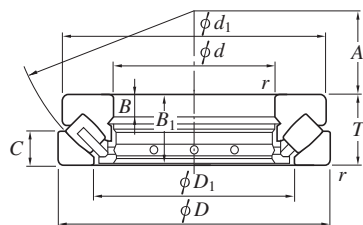

Boundary dimensions (mm)				Basic load ratings (kN)		Fatigue load limit (kN)	Bearing No.	Dimensions (mm)						Mounting dimensions (mm)			(Refer.) Mass (kg)
d	D	T	$r_{min.}$	C_a	C_{0a}	C_u		d_1	D_1	B	B_1	C	A	d_a min.	D_a max.	r_a max.	Mass
220	420	122	6	3 160	8 990	619	29444R	400	308	43	117	58	132	310	355	5	76.9
240	340	60	2.1	1 030	3 670	233	29248	330	283	19	57	30	130	285	305	2	16.9
	380	85	4	1 790	5 330	99.0	29348A	365	300	29	81	41	135	300	330	3	35.5
	440	122	6	3 260	9 510	659	29448R	420	326	43	117	59	142	330	375	5	81.4
260	360	60	2.1	1 050	3 720	240	29252	350	302	19	57	30	139	305	325	2	18.5
	420	95	5	1 960	6 040	389	29352	405	329	32	91	45	148	330	365	4	49.1
	480	132	6	3 760	11 100	764	29452R	460	357	48	127	64	154	360	405	5	106
280	380	60	2.1	1 030	4 020	225	29256	370	323	19	57	30	150	325	345	2	19.0
	440	95	5	2 200	6 870	439	29356	423	348	32	91	46	158	350	390	4	53.2
	520	145	6	4 560	13 600	907	29456R	495	387	52	140	68	166	390	440	5	138
300	420	73	3	1 330	4 880	302	29260	405	353	21	69	38	162	355	380	2.5	30.5
	480	109	5	2 470	7 780	496	29360	460	379	37	105	50	168	380	420	4	74.9
	540	145	6	4 670	14 200	925	29460R	515	402	52	140	70	175	410	460	5	144
320	440	73	3	1 780	6 480	321	29264R	430	372	21	69	38	172	375	400	2.5	32.7
	500	109	5	2 890	9 380	573	29364	482	399	37	105	53	180	400	440	4	78.0
	580	155	7.5	5 190	16 100	1 040	29464R	555	435	55	149	75	191	435	495	6	179
340	460	73	3	1 800	6 420	307	29268R	445	395	21	69	37	183	395	420	2.5	34.7
	540	122	5	3 810	12 700	890	29368R	520	428	41	117	59	192	430	470	4	106
	620	170	7.5	6 190	19 400	1 210	29468R	590	462	61	164	82	201	465	530	6	224
360	500	85	4	1 650	6 080	332	29272	485	423	25	81	44	194	420	455	3	51.8
	560	122	5	3 890	13 200	923	29372R	540	448	41	117	59	202	450	495	4	110
	640	170	7.5	6 440	20 600	1 300	29472R	610	480	61	164	82	210	485	550	6	235
380	520	85	4	1 750	6 610	343	29276	505	441	27	81	42	202	440	475	3	52.8
	600	132	6	4 430	15 000	1 030	29376R	580	477	44	127	63	216	480	525	5	140
	670	175	7.5	6 780	22 000	1 300	29476R	640	504	63	168	85	230	510	575	6	264
400	540	85	4	1 980	7 610	377	29280	526	460	27	81	42	212	460	490	3	55.3
	620	132	6	4 630	16 100	1 080	29380R	596	494	44	127	64	225	500	550	5	144

Spherical thrust roller bearings

d 800 ~ 1 060 mm

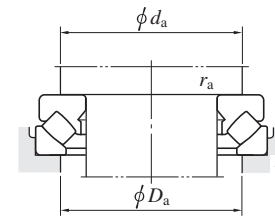
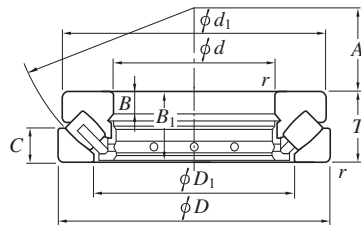

Boundary dimensions (mm)				Basic load ratings (kN)		Fatigue load limit (kN)	Bearing No.	Dimensions (mm)						Mounting dimensions (mm)			(Refer.) Mass (kg)
d	D	T	$r_{\min.}$	C_a	C_{0a}	C_u		d_1	D_1	B	B_1	C	A	d_a min.	D_a max.	r_a max.	
800	1 180	230	9.5	11 500	45 700	1 860	293/800	1 146	965	78	222	112	440	975	1 055	8	850
1 060	1 400	206	9.5	11 100	52 000	864	292/1060	1 370	1 208	66	199	108	566	1 210	1 285	8	850

Bearings for continuous casting machines

- In continuous casting machines, roll support bearings are used under heavy loads and at extremely low speed. In addition, the operating conditions are severe, resulting in exposure to splashing water and scales.
- SCP bearings for fixed side and SC bearings for free side are used for end of rolls.
- HSC bearing units with half-round outer ring is used for the intermediate support section of beetle-shape rolls, such as driving rolls.
- JTEKT bearings for continuous casting machines are designed based on a full complement cylindrical roller bearing, with reference to maximized static load ratings. Crowning are set up on rolling surface of its rollers, according to the size of loads, which contributes to solve stress concentration at specific location.
- The bearing has the self-aligning mechanism to absorb roll bending and misalignment due to heavy load.

■ SC bearings (free side)
(page 436)

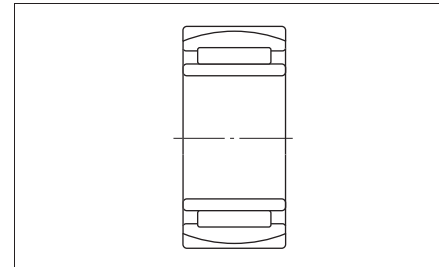

- To accommodate thermal contraction and expansion of roll, the inner ring of this bearing are designed to move smoothly in the axial direction.

■ SCP bearings (fixed side)
(page 436)

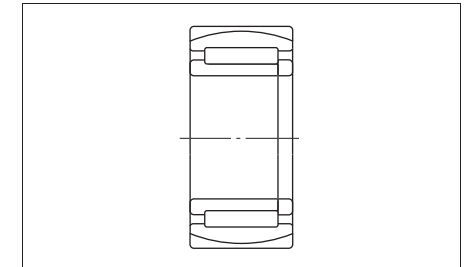

- The bearing has been developed for the purpose of improvement in short service life of spherical roller bearings most commonly used for continuous casting machines.
- The ribs provided for the inner and outer rings and loose rib allow accommodation of axial loads generated by thermal contraction and expansion of rolls.

■ HSC bearing units with half-round outer ring (page 442)

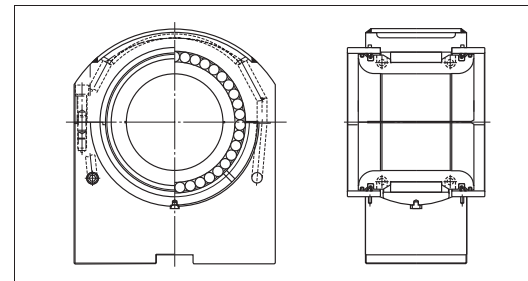

- To accommodate thermal contraction and expansion of roll, the inner ring and roller of this bearing are designed to move smoothly in the axial direction.
- This unit has unique structure, with a half-round outer ring placed on the loaded side only.
- This special half-round outer ring and compact seal design realizes a 15 % increase in static load rating over that of conventional products.
- The unique jacket design adjusts the flow of water and enables a high cooling efficiency, equivalent to that of conventional products with a lower water flow rate of 55 %.

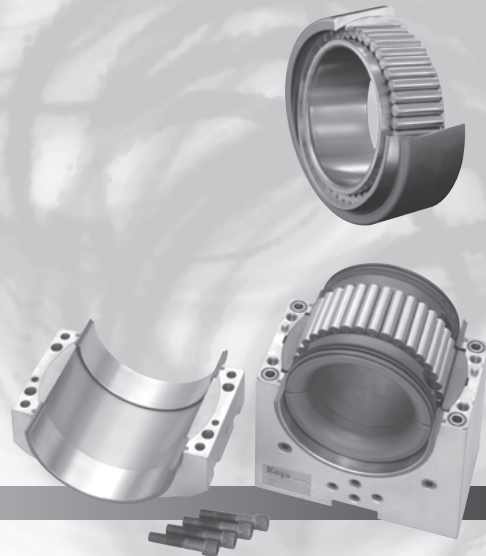

d 50 ~ (110) mm

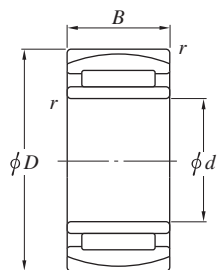

Design 1

SC bearings (free side)

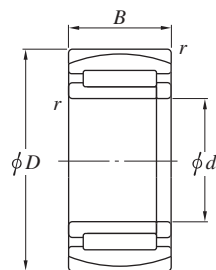

Design 2

SCP bearings (fixed side)

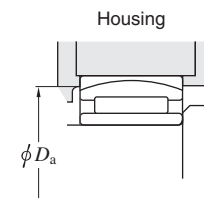

Boundary dimensions (mm)				Acceptable roll heat expansion (mm)	Basic load ratings (kN)		Bearing No.	Corresponding spherical roller bearing Bearing No.	Basic load ratings (kN)		Mass (kg)	Mounting dimensions (mm) D_a		Design
d	D	B	$r_{min.}$		C_r	C_{0r}			C_r	C_{0r}		min.	max.	
50	110	40	2	±4.5	164	254	SC101140VA	22310RHR	204	237	2.1	96	99	1
55	90	32	1.1	±3.5	89.9	202	SC119032VA	—	—	—	0.9	81	82	1
		100	25											
65	120	31	1.5	±4	118	206	SC131231V-1A	22213RHR	178	211	1.7	110	111	1
		140	48											
70	125	31	1.5	±6	126	213	SC141331VA	22214RHR	187	222	1.8	116	117	1
		150	51											
75	130	31	1.5	±5	148	237	SC151331VA	22215RHR	193	236	1.9	120	121	1
85	150	65	3	±8	280	621	SC171565VA	24217RHB	370	558	5.4	129	137	1
		150	65											
90	160	40	2	±4.5	240	427	SC181640-1VA	22218RHR	298	381	3.8	147	149	1
	160	40	2	—	194	400	SCP181640V-1A	22218RHR	298	381	3.9	147	149	2
	160	52.4	2	±5.5	309	555	SC181652VA	23218RH	336	482	4.9	144	148	1
	160	52.4	1.1	—	271	566	SCP181652V-2A	23218RH	336	482	5.1	144	148	2
	160	45/48	2	±5.5	249	507	SC181645/48V-1A	—	—	—	4.4	147	150	1
100	150	50	1.5	±6	232	543	SC201550VA	—	—	—	3.4	137	139	1
	150	50	1.5	—	232	543	SCP201550VA	—	—	—	3.4	137	139	2
	165	52	2	±5.5	279	600	SC201752V-1A	23120RH	328	510	4.8	149	153	1
105	160	56	2	±9	242	594	SC211656VA	24021RHA	317	550	4.4	144	149	1
110	170	45	2	±5.5	260	523	SC221745V-3A	23022RH	300	486	4.0	158	160	1
	170	45	2	—	260	523	SCP221745V-3A	23022RH	300	486	4.1	158	160	2
	170	60	2	±8	279	722	SC221760V-1A	24022RH	375	647	5.5	152	157	1
	170	64	2	±10	279	722	SC221764VA	—	—	—	5.8	151	157	1
	180	56	2	±7.5	296	667	SC221856V-8A	23122RH	385	605	6.1	162	167	1
	180	69	2	±9	355	842	SC221869V-3A	24122RH	469	778	7.6	157	164	1

Bearings for continuous casting machines

d (110) ~ (150) mm

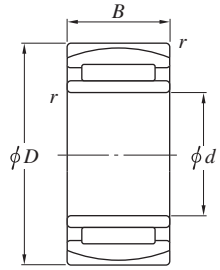

Design 1

SC bearings (free side)

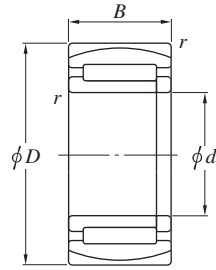

Design 2

SCP bearings (fixed side)

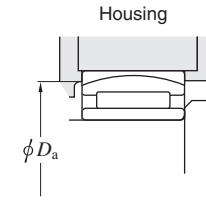

Boundary dimensions (mm)				Acceptable roll heat expansion (mm)	Basic load ratings (kN)		Bearing No.		Corresponding spherical roller bearing			Mass (kg)	Mounting dimensions (mm)		Design	
d	D	B	$r_{min.}$		C_r	C_{0r}			Bearing No.	Basic load ratings (kN)			D_a	min.		max.
										C_r	C_{0r}					
110	180	69	2	—	355	842	SCP221869V-3A	24122RH	469	778	7.8	157	164	2		
	200	53	2.1	—	333	626	SCP222053VA	22222RHR	491	642	8.2	182	187	2		
120	180	46	2	±6	231	588	SC241846V-2A	23024RH	314	524	4.5	168	170	1		
	180	46	2	—	231	588	SCP241846V-2A	23024RH	314	524	4.6	168	170	2		
	180	54	2	±12	246	516	SC241854VA	—	—	—	5.0	165	169	1		
	180	58	2	±8	274	726	SC241858V-1A	—	—	—	5.7	164	168	1		
	180	60	2	±9	274	726	SC241860V-1A	24024RH	397	709	5.8	163	168	1		
	180	56/46	2	±10	279	626	SC241856/46VA	—	—	—	5.2	165	169	1		
	200	80	2	±9.5	521	1 120	SC242080VA	24124RH	605	1 020	11.1	174	183	1		
	200	80	2	—	431	1 040	SCP242080V-3A	24124RH	605	1 020	12.0	174	183	2		
130	200	52	2	—	295	701	SCP262052V-1A	23026RH	404	674	6.7	186	189	2		
	200	69	2	±9	381	969	SC262069V-1A	24026RH	512	914	8.7	179	186	1		
	200	69	2	—	381	969	SCP262069V-1A	24026RH	512	914	8.9	179	186	2		
	200	79/69	2	±11	443	1 090	SC262079/69VA	—	—	—	9.6	177	185	1		
	210	64	2	±10	408	882	SC262164VA	23126RH	494	799	9.2	190	196	1		
	210	80	2	±11.5	448	1 120	SC262180V-2A	24126RH	620	1 080	11.9	184	193	1		
	210	80	2	—	448	1 120	SCP262180V-2A	24126RH	620	1 080	12.2	184	193	2		
	230	64	3	±9	442	950	SC262364V-2A	22226RHR	658	914	12.5	209	215	1		
	140	210	53	2	±6	331	834	SC282153V-1A	23028RH	422	723	7.1	195	199	1	
210		53	2	—	331	834	SCP282153V-1A	23028RH	422	723	7.2	195	199	2		
210		69	2	±9.5	431	1 010	SC282169RVA	24028RH	524	957	8.8	191	196	1		
210		69	2	—	431	1 010	SCP282169RVA	24028RH	524	957	9.3	191	196	2		
225		68	2.1	±7	512	1 150	SC282368RVA	23128RH	565	940	11.1	204	210	1		
225		68	2.1	—	465	1 020	SCP282368V-1A	23128RH	565	940	11.6	204	210	2		
225		85	2.1	±11.5	521	1 300	SC282385V-1A	24128RH	702	1 220	14.4	199	208	1		
225		85	2.1	—	521	1 300	SCP282385V-1A	24128RH	702	1 220	14.8	199	208	2		
150		225	75	2.1	±9	492	1 220	SC302375V-6A	24030RH	593	1 100	11.4	203	209	1	
	225	75	2.1	—	492	1 220	SCP302375V-6A	24030RH	593	1 100	11.8	203	209	2		

d (150) ~ 220 mm

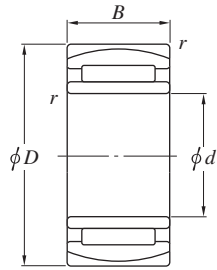

Design 1

SC bearings (free side)

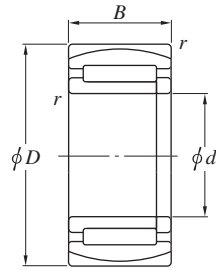

Design 2

SCP bearings (fixed side)

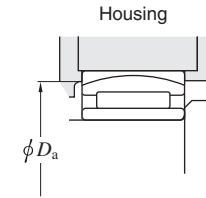

d	Boundary dimensions (mm)			Acceptable roll heat expansion (mm)	Basic load ratings (kN)		Bearing No.	Corresponding spherical roller bearing Bearing No.	Basic load ratings (kN)		Mass (kg)	Mounting dimensions (mm) D_a		Design
	D	B	$r_{min.}$		C_r	C_{0r}			C_r	C_{0r}		min.	max.	
150	250	100	2.1	±14	666	1 650	SC3025100V-1A	24130RH	915	1 590	21.9	218	230	1
	270	96	3	±12	806	1 670	SC302796VA	23230RH	959	1 540	26.2	236	247	1
160	240	80	2.1	±13	542	1 280	SC322480-2VA	24032RH	679	1 270	13.6	216	225	1
	270	109	2.1	±13.5	867	1 980	SC3227109VA	24132RH	1 070	1 890	28.0	233	247	1
	340	114	4	±15	1 230	2 300	SC3234114VA	22332RHA	1 420	1 940	55.3	303	316	1
170	260	90	2.1	±14	622	1 560	SC342690V-1A	24034RH	828	1 540	18.7	232	241	1
	260	90	2.1	—	622	1 560	SCP342690V-1A	24034RH	828	1 540	19.1	232	241	2
	310	110	4	±14	1 010	2 180	SC3431110VA	23234RHA	1 210	1 940	40.1	270	285	1
180	280	100	2.1	±14	743	1 890	SC3628100V-1A	24036RH	984	1 830	25.0	248	260	1
	320	112	4	±15	950	2 350	SC3632112V-1A	23236RHA	1 320	2 170	43.5	280	295	1
	320	112	4	—	950	2 350	SCP3632112V-1A	23236RHA	1 320	2 170	44.1	280	295	2
190	290	75	2.1	—	595	1 530	SCP382975V-1A	23038RHA	789	1 430	20.3	268	274	2
	290	100	2.1	±14	768	2 030	SC3829100V-1A	24038RHA	1 010	1 920	26.1	259	269	1
	290	100	2.1	—	768	2 030	SCP3829100V-1A	24038RHA	1 010	1 920	26.8	259	269	2
	320	104	3	±12	1 030	2 270	SC3832104VA	23138RHA	1 210	2 080	37.2	288	298	1
	320	128	4	±15.5	1 120	2 790	SC3832128VA	24138RHA	1 460	2 630	46.7	278	293	1
	320	128	4	—	1 120	2 790	SCP3832128VA	24138RHA	1 460	2 630	47.8	278	293	2
	340	120	4	±16	1 110	2 720	SC3834120V-1A	23238RHA	1 490	2 470	53.0	301	315	1
200	310	82	2.1	—	692	1 810	SCP403182VA	23040RHA	940	1 680	25.9	282	291	2
	310	109	2.1	±11	978	2 550	SC403111RVA	24040RHA	1 180	2 230	33.5	273	286	1
	340	112	3	±16	1 080	2 490	SC4034112V-1A	23140RHA	1 380	2 340	46.0	304	317	1
	340	140	3	±19	1 350	3 090	SC4034140VA	24140RHA	1 660	2 970	56.1	292	313	1
220	370	150	4	±19	1 540	3 750	SC4437150VA	24144RHA	1 920	3 550	72.3	320	340	1

D 195 ~ (260) mm

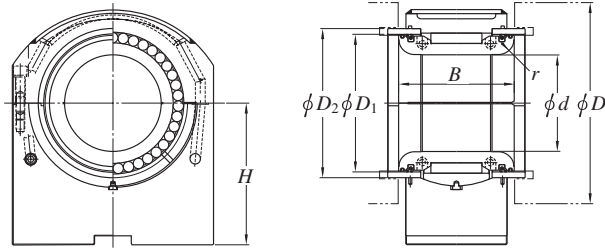

Roll outside dia.	Boundary dimensions (mm)						Housing unit No.		Seal type		Bearing No.	Acceptable roll heat expansion (mm)	Basic load ratings (kN)	
	D	d	B	H	D ₁	D ₂			r	Recovery type			Non-recovery type	C _r
195	100	145	175	133	143	C8	PBA391H	—	○	HSC2017-1C3	±7	373	876	
220	110	139	225	155	168	18	PBA399H	○	—	HSC2219-7C3	±9	402	876	
	110	139	225	155	168	18	PBA360H	○	—	HSC2219-6C3	±9	433	966	
225	100	169	132	140	150	15	PBA328H	—	○	HSC2019C3	±8	603	1 250	
230	110	113	185	160	173	13	PBA171H	—	○	HSC2219-3C3	±8	337	619	
	110	113	185	160	173	13	PBA171H	○	—	HSC2219-8C3	±8	337	619	
	110	141	246	160	173	18	PBA171AXH	—	○	HSC2219-1C3	±8	528	1 120	
	110	148	351	160	173	13	PBA171AH	—	○	HSC2219C3	±8	421	846	
	110	148	351	160	173	13	PBA171AH	○	—	HSC2219-9C3	±8	421	846	
	110	150	190	160	173	15	PBA208H	—	○	HSC2219-2C3	±8	554	1 190	
	110	150	190	160	173	15	PBA208H	○	—	HSC2219-11C3	±8	554	1 190	
	110	154	180	160	173	20	PBA368H	—	○	HSC2219-4C3	±8	554	1 190	
110	154	180	160	173	20	PBA404H	○	—	HSC2220C3	±9	575	1 270		
235	140	145	175	175	186.5	C8	PBA339H	—	○	HSC2821C3	±5	431	1 160	
240	115	202	251	160	175	15	PBA316H	—	○	HSC2321C3	±10	745	1 550	
	115	202	251	160	175	15	PBA316H	○	—	HSC2321-2C3	±10	745	1 550	
	120	173	230	165	180	15	PBA396H	○	—	HSC2421-2C3	±9	673	1 510	
250	120	151	190	172	185	20	PBA411H	○	—	HSC2421-6C3	±9	576	1 310	
	120	153	185	175	190	20	PBA336H	—	○	HSC2421C3	±8	651	1 380	
	120	153	145	175	190	20	PBA336AH	—	○	HSC2421C3	±8	651	1 380	
	120	154	175	170	188	20	PBA378H	○	—	HSC2421-1C3	±10	578	1 190	
	120	154	190	175	190	20	PBA251H-2	○	—	HSC2421-4C3	±9	605	1 400	
	120	154	180	175	190	20	PBA251H	—	○	HSC2421-3C3	±9	605	1 400	
	120	154	180	170	185	20	PBA407H	○	—	HSC2421-5C3	±9	605	1 400	
255	125	174	180	180	195	20	PBA410H	○	—	HSC2522C3	±9	793	1 740	
260	120	154	180	170	188	20	PBA379H	○	—	HSC2421-1C3	±10	578	1 190	

D (260) ~ 320 mm

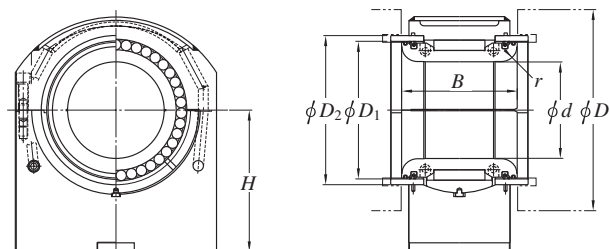

Roll outside dia. <i>D</i>	Boundary dimensions (mm)						Housing unit No.	Seal type		Bearing No.	Acceptable roll heat expansion (mm)	Basic load ratings (kN)	
	<i>d</i>	<i>B</i>	<i>H</i>	<i>D</i> ₁	<i>D</i> ₂	<i>r</i>		Recovery type	Non-recovery type			<i>C</i> _r	<i>C</i> _{0r}
260	130	157	180	185	200	20	PBA412H	○	—	HSC2622-2C3	±9	623	1 480
265	140	175	242.5	190	205	20	PBA397H	○	—	HSC2823-2C3	±9	699	1 640
	140	191	250	190	205	20	PBA355H	—	○	HSC2823-1C3	±7	721	1 710
270	130	154	190	185	200	20	PBA252H	—	○	HSC2622C3	±9	623	1 480
	140	126	205	199	212	16	PBA176H	—	○	HSC2823C3	±8	505	992
	140	126	205	199	212	16	PBA176H	○	—	HSC2823-3C3	±8	505	992
	140	174	205	199	212	20	PBA207H	—	○	HSC2824-1C3	±8	863	1 980
	140	174	205	199	212	20	PBA207H	○	—	HSC2824-4C3	±8	863	1 980
275	150	163	175	190	203.5	C10	PBA389H	—	○	HSC3024C3	±7	711	1 800
280	130	174	205	185	200	20	PBA337H	—	○	HSC2624C3	±8	846	1 910
	130	174	160	185	200	20	PBA337AH	—	○	HSC2624C3	±8	846	1 910
	145	196	260	200	215	20	PBA356H	—	○	HSC2925-1C3	±6	840	1 930
290	140	139	215	208	223	16	PBA177H	—	○	HSC2825C3	±8	863	1 980
	140	139	215	208	223	16	PBA177H	○	—	HSC2825-1C3	±8	863	1 980
	145	178	215	208	223	20	PBA206H	—	○	HSC2925C3	±8	967	2 260
	145	178	215	208	223	20	PBA206H	○	—	HSC2925-2C3	±8	967	2 260
295	145	208	270	200	215	20	PBA357H	—	○	HSC2926C3	±6	880	2 260
305	150	169	205	205	220	20	PBA408H	○	—	HSC3025C3	±8.5	855	1 990
	310	140	184	215	205	220	20	PBA338H	—	○	HSC2827C3	±8	1 000
	140	184	175	205	220	20	PBA338AH	—	○	HSC2827C3	±8	1 000	2 210
320	150	187	220	220	235	20	PBA380H	—	○	HSC3028C3	±9	1 040	2 370
	160	150	291	240	255	18	PBA178H	—	○	HSC3228C3	±8	816	1 680
	160	150	291	240	255	18	PBA178H	○	—	HSC3228-2C3	±8	816	1 680
	160	199	270	215	230	20	PBA398H	○	—	HSC3227C3	±9	1 000	2 410
	165	228	280	230	245	25	PBA358H	—	○	HSC3328C3	±6	1 030	2 550

D 340 ~ 370 mm

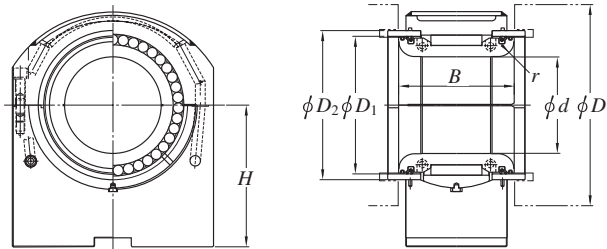

Roll outside dia. D	Boundary dimensions (mm)						Housing unit No.	Seal type		Bearing No.	Acceptable roll heat expansion (mm)	Basic load ratings (kN)	
	d	B	H	D_1	D_2	r		Recovery type	Non-recovery type			C_r	C_{0r}
340	180	235	280	245	260	25	PBA359H	—	○	HSC3630C3	±6	1 140	2 720
370	190	233	280	326	336	20	PBA324H	—	○	HSC3834C3	±7	1 540	3 540

Cylindrical roller bearings for the backing shafts of multi-roll mills

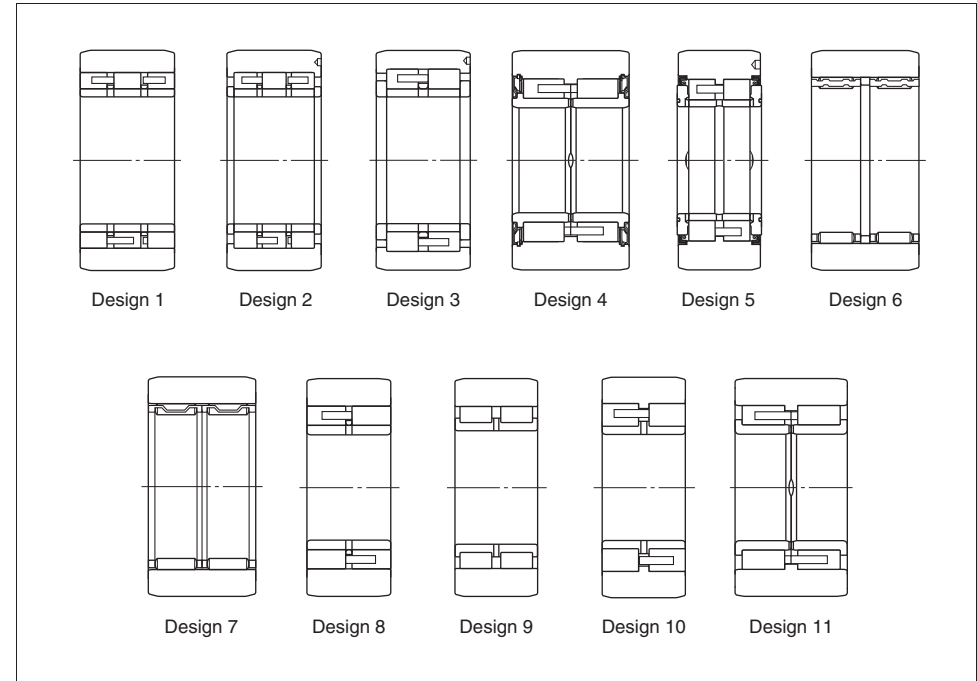

- Since the bearing is used as the back up roll in multi-roll mills, the outer ring is designed thicker than ordinary bearings.
- Since high accuracy is required for these bearings under high pressure, they are designed to have high load rating and accuracy.
- Since several bearings are mounted on a shaft, radial runout of outer ring and variations of bearing section height per unit after assembly are minimized.
- Even if the outside surface of bearing's outer ring gets rough due to foreign matters caught in, the bearing can be used again by grinding.
- Bearings installed on the backing shaft come in cylindrical roller bearing and long cylindrical roller bearing. Either of both type bearings is used appropriately depending on the characteristics of rolling mills. Above all, the cylindrical roller bearing is most commonly used.
- **These bearings are commonly used for the backing shafts of multi-roll mills.**

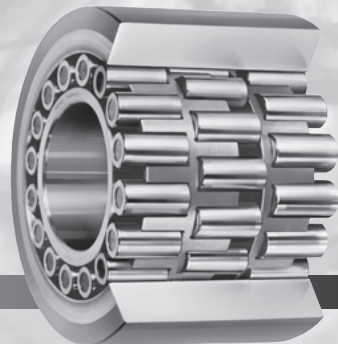

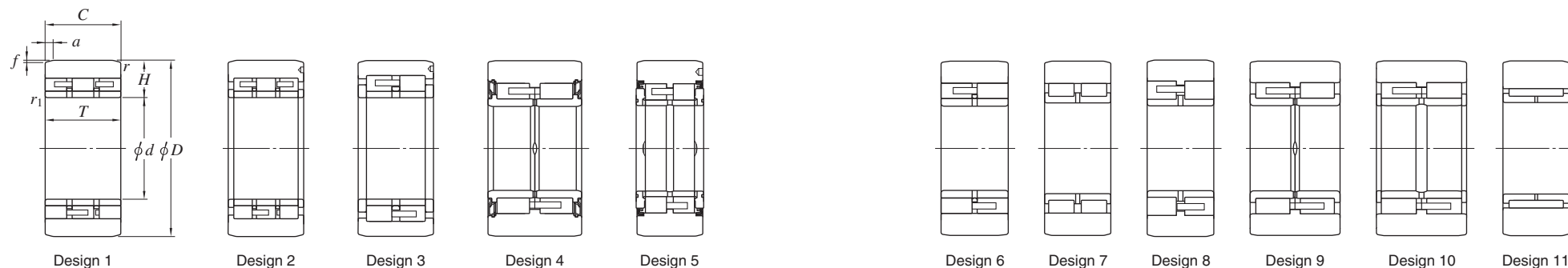

Boundary dimensions (mm)						Basic load ratings (kN)		Fatigue load limit (kN) C_u	Bearing No.	Design	Bearing section height at the time of manufacture (mm) H	Mass (kg)	Compatible rolling mill model	Number of bearings used
d	D	T	C	r	r_1	C_r	C_{0r}							
31.75	76.2	46.23	45.85	0.8	1.5	121	183	31.5	06DC0846A	7	22.200	1.27	ZR34	40
54.999	120	25.999	25.999	1.6	1.6	99.3	138	18.8	11N1226V	11	32.4672	1.69	ZR24	24, 56
55	120	52.197	52	1.6	1.6	254	341	45.9	11DC1252	7	32.483	3.27	ZR24	40
70	160	90	90	1.5	1.5	434	546	81.2	14DC1690LDS-1	9	44.977	10.1	ZR33	40
	160.070	90	90	1.5	1.5	475	667	101	14DC1690ADS	1	45.000	10.5	ZR33	32, 48, 72
90	190	100	100	3	3	593	770	109	18DC19100NDS	9	49.980	14.7	ZR25	48
99.995	225	120	120	1.5	1.5	780	995	135	20DC23120KDS-2	4	62.474	26.0	ZR23	32, 40, 48
100	225	100	100	3	1.5	683	838	114	20DC23100NDS-1	9	62.480	21.7	ZR23	40
	225.021	80	80	1.5	1.5	759	991	136	20DC23080DS	6	62.474	18.2	ZR23	12(36)
	225.021	120	120	1.5	1.5	1 020	1 440	199	20DC23120MDS	1	62.474	27.2	ZR23	32
130	300	160	159.5	4	3.5	1 660	2 340	297	26DC30160DS	1	84.9617	64.8	ZR22	40, 48
	300	172.644	172.644	4	3.5	1 950	2 900	363	26DC30170MDS	1	84.955	72.6	ZR22	40, 48
	300	172.644	172.644	4	3.5	1 650	2 210	275	26DC30170KDS-3	4	84.955	70.0	ZR22	40, 48
179.984	406.430	223.960	217	4	0.5	2 940	4 500	515	36DC41217DS+DP	1	113.155	161	ZR21	40, 48
	406.430	224.250	220	4	3	2 430	3 530	405	36DC41224KDS	4	113.181	160	ZR21	32, 48
180	406.420	171.040	171.040	4	4	2 580	3 810	450	36DC41171DS	1	113.155	130	ZR21	48, 56
	406.420	171.040	171.040	4	1	2 390	3 340	389	36DC41171ADS	10	113.155	124	ZR21	48, 56
	406.420	171.040	171.040	4	3	2 090	2 960	346	36DC41171KDS	4	113.155	125	ZR21	48
	406.420	224.250	224	4	3	2 860	4 230	480	36DC41224QDS	9	113.155	162	ZR21	40, 48
50	120	80	80	1.5	1.5	335	379	56.4	10DC1280DS	3	34.976	5.15	12-ROLL MILL	32
	120	85	85	1.5	1.5	379	427	63.2	10DC1285DS	3	34.984	5.4	12-ROLL MILL	32
60	160	95	95	1.5	2	498	589	88.3	12DC1695DS	3	46.484	11.5	12-ROLL MILL	20(32)
65	170	100	100	2	2	498	597	89.6	13DC17100DS	3	52.480	13.5	12-ROLL MILL	10(34)

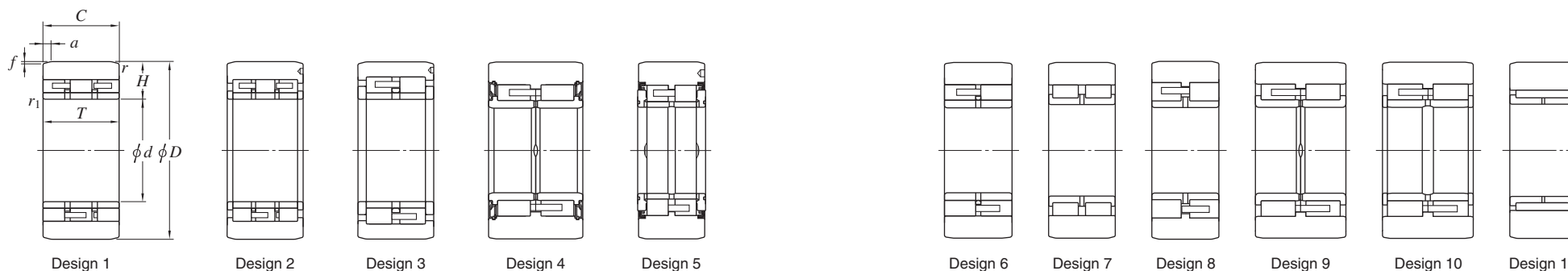

Boundary dimensions (mm)						Basic load ratings (kN)		Fatigue load limit (kN) C_u	Bearing No.	Design	Bearing section height at the time of manufacture (mm) H	Mass (kg)	Compatible rolling mill model	Number of bearings used
d	D	T	C	r	r_1	C_r	C_{0r}							
90	230	100	100	2	3	802	982	133	18DC23100DS 18DC26125DS	3	69.980	24.2	12-ROLL MILL 12-ROLL MILL	24(34)
	260	125	125	2	2	1 150	1 520	197			84.970	41.3		34
100	260	95	95	2	2	871	1 060	143	20DC2695DS 20DC26105DS 20DC26130DS	3	79.970	30.2	12-ROLL MILL 12-ROLL MILL 12-ROLL MILL	32
	260	105	105	2	2	975	787	161			79.970	33.5		32
	260	130	130	2	2	1 190	1 580	204			79.970	41.5		32
110	280	165	165	2	2	1 390	1 880	250	22DC28165DS	2	84.965	60.2	12-ROLL MILL	10(34)
120	280	165	165	2	3	1 380	1 940	244	24DC28165DS 24DC35165ADS	3	79.965	57.7	12-ROLL MILL 12-ROLL MILL	14(38)
	350	165	165	2	3	1 710	2 220	273			114.965	98.3		24(34)
130	350	175	175	2	3	1 750	2 300	281	26DC35175DS	10	109.965	101	12-ROLL MILL	24(38)
62	155	90	90	1	2	445	529	78.3	12DC1690DS 12DC16110DS	3	46.484	9.97	20-ROLL MILL 20-ROLL MILL	8(44)
	155	110	110	1	2	505	622	95.6			46.484	12.2		36(44)
90	220	95	95	2	2	664	795	112	18DC2295DS 18DC22130ADS	3	64.982	20.9	20-ROLL MILL 20-ROLL MILL	40
	220	130	130	2	2	873	1 130	158			64.982	28.7		32, 40
115	260	140	140	3	2	1 220	1 690	225	23DC26140DS	2	72.470	41.9	20-ROLL MILL	40
65	165	70	70	1.5	2	531	586	90.1	13DC1770DS	8	49.982	8.83	20-ROLL MILL	40
90	220	94	94	2	1.5	860	997	138	18DC2294DS 18DC2294/96DS	8	64.976	21.2	20-ROLL MILL 20-ROLL MILL	40
	220	96	94	3	3	618	700	101			65.000	21.0		64
130	300.020	130	129	2	3	1 300	1 740	215	26DC30130DS 26DC30130BDS 26DC30132ADS	3	85.010	52.2	20-ROLL MILL 20-ROLL MILL 20-ROLL MILL	56
	300.020	130	129	4	3.5	1 340	1 620	206			85.010	51.8		—
	300.020	132	129	2	3	1 430	1 830	231			85.010	53.8		72

Slewing rim bearings for tunnel-boring machine

- These bearings are designed to support the main cutters of tunnel-boring machines.

■ DTR...T (triple-row combined roller type) (page 456)

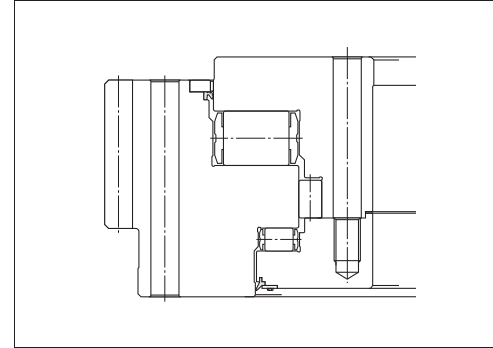

The DTR...T slewing rim bearing is a triple-row combined cylindrical roller bearing. This bearing is provided with various features required to support the main cutters of tunnel-boring machines, including superior impact resistance, high load ratings, and excellent sealing performance. When used with forced oil circulation, this bearing is provided with oil supply and oil drain ports.

As the sealing mechanism of this bearing, a labyrinth, dust seal, or pressure-resistant seal featuring high sealing performance (resistant to a static pressure of 0.3 MPa) can be selected, depending on the lubrication method used.

For convenience of transportation, DTR...T bearings with the bearing rings split cylindrically into two or four parts are also available (SP/DTR...T).

■ 2TR... (double-row tapered roller type) (page 464)

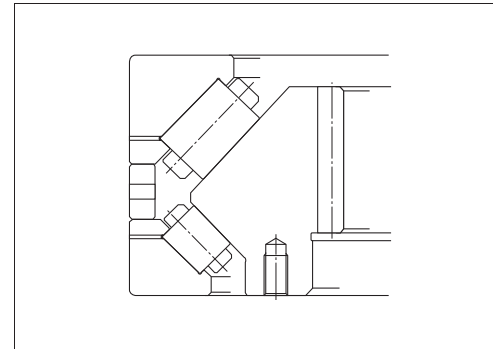

The 2TR... slewing rim bearing is a double-row tapered roller bearing. To ensure high axial load ratings, this bearing features a large contact angle. Large-sized rollers are provided on the axial load-accommodating side.

The bearing ring on the non-gear side is made from bearing steel. It is treated through normal hardening, so therefore does not have any "soft zone," which an induction-hardened bearing may have, thus eliminating limits in determining the location of the non-gear-side bearing ring on machines or equipment.

The 2TR... bearing was developed to support the main cutters (oil bath lubrication) of tunnel-boring machines.

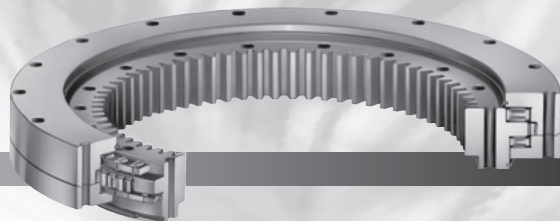

Slewing rim bearings for tunnel-boring machine

DTR...T type (With internal gear)

D_a 2 550 ~ 5 200 mm

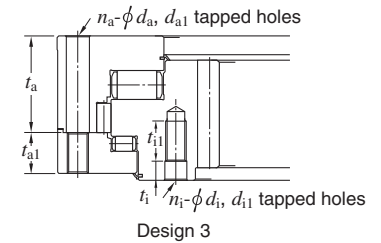
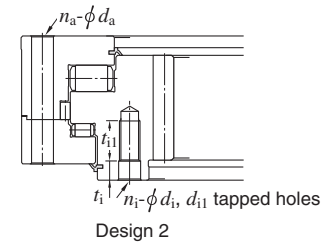
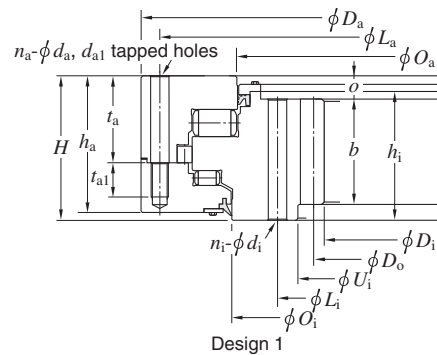

Bearing No.	De- sign	Outside dia. D_a	Bore dia. D_i	Height H	Gear data (pressure angle 20°)			Dimensions							Mounting-hole of outer ring						Mounting-hole of inner ring						Roller PCD	Basic static axial load rating C_{0a} (kN)	Gear specifications		(Refer.) Mass (kg)
					D_o	Module	No. of tooth	b	h_a	h_i	o	O_a	O_i	U_i	Qty.	L_a	n_a	d_a	t_a	d_{a1}	t_{a1}	Qty.	L_i	n_i	d_i	t_i			d_{i1}	t_{i1}	
DTR2096TBGS	1 ¹⁾	2 550	2 096	240	2 128	16	133	190	175	210	30	2 298	2 324	2 180	2 500	48	φ24	110	M22	45	2 230	48	φ24	—	—	—	2 357	20 900	—	○	2 150
DTR2156TBGS-1	1 ²⁾	2 595	2 156	240	2 184	14	156	190	175	210	30	2 384	2 383	2 230	2 545	48	φ24	120	M22	40	2 285	48	φ24	—	—	—	2 428	19 000	—	○	2 140
DTR2176TBGS	1 ¹⁾	2 630	2 176	240	2 208	16	138	190	175	210	30	2 378	2 404	2 260	2 580	48	φ24	110	M22	45	2 310	48	φ24	—	—	—	2 437	21 400	—	○	2 200
DTR2160TBGS	1	2 660	2 160	220	2 192	16	137	160	195	190	30	2 420	2 425	2 240	2 600	60	φ26	123	M24	50	2 300	60	φ26	—	—	—	2 474	20 200	—	○	2 480
DTR2240TBGS	1 ¹⁾	2 705	2 240	240	2 272	16	142	190	175	210	30	2 451	2 477	2 325	2 655	60	φ24	110	M22	45	2 380	60	φ24	—	—	—	2 510	22 300	—	○	2 360
DTR2296ATBGS-1	1 ²⁾	2 735	2 296	200	2 324	16	142	190	175	210	30	2 451	2 477	2 325	2 655	60	φ24	110	M22	45	2 380	60	φ24	—	—	—	2 550	29 500	—	○	2 360
DTR2208TBG	1	2 855	2 208	275	2 240	16	140	150	265	240	35	2 512	2 575	2 295	2 790	48	φ33	175	M30	50	2 350	48	φ33	—	—	—	2 595	35 000	—	○	4 470
DTR2674TBGS	2	3 025	2 674	245	2 702	14	193	160	230	215	30	2 855	2 920	2 750	3 140	48	φ33	—	—	—	2 810	48	φ33	30	M30	60	2 940	39 500	—	○	3 790
DTR2816TBGS	1	3 460	2 816	260	2 848	16	178	160	245	230	30	3 125	3 180	2 900	3 400	60	φ30	155	M27	50	2 960	72	φ30	—	—	—	3 210	43 500	—	○	5 240
DTR2960TBGS-1	1	3 645	2 960	300	3 000	20	150	225	270	265	35	3 300	3 320	3 065	3 570	48	φ39	165	M36	60	3 140	60	φ39	—	—	—	3 375	50 300	—	○	6 570
DTR3080TBGS	3	3 750	3 080	295	3 120	20	156	220	280	245	50	3 310	3 415	3 180	3 660	72	φ45	197	M42	83	3 260	72	—	—	M42	85	3 419	63 500	—	○	6 540
DTR3240ATBGS-1	1	3 925	3 240	300	3 280	20	164	225	270	265	35	3 580	3 600	3 345	3 850	48	φ39	165	M36	60	3 420	60	φ39	—	—	—	3 655	53 000	—	○	7 120
DTR3250TBGS	1	3 925	3 250	300	3 280	20	164	225	270	265	35	3 570	3 610	3 355	3 850	48	φ39	165	M36	60	3 430	60	φ39	—	—	—	3 655	53 000	0.25	○	6 970
DTR3834BTBGS	3	4 480	3 834	305	3 870	18	215	200	280	275	30	4 050	4 155	3 925	4 400	60	φ39	197	M36×3	83	4 000	60	φ39	40	M36×3	80	4 159	78 600	—	○	8 120
DTR3996TBGS-1	3	4 700	3 996	348	4 032	18	224	210	328	296	52	4 215	4 330	4 085	4 615	88	φ39	225	M36	103	4 175	88	φ39	50	M36	75	4 335	92 100	—	○	10 500
DTR4176ATBGS	1	5 200	4 176	380	4 224	24	176	290	345	340	40	4 560	4 755	4 300	5 080	100	φ48	230	M45	75	4 395	100	φ48	—	—	—	4 733	159 000	—	○	6 970

[Notes] 1) Without oil seals.
2) With seal upper side only.

Slewing rim bearings for tunnel-boring machine

DTR...T type (With external gear)

D_a 2 688 ~ 4 550 mm

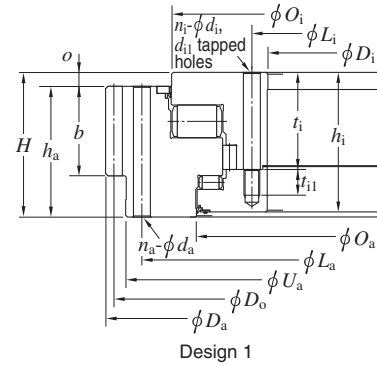

Design 1

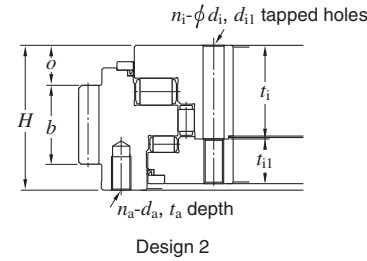

Design 2

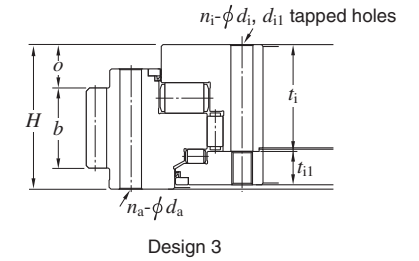

Design 3

Bearing No.	De- sign	Outside dia. D_a	Bore dia. D_i	Height H	Gear data (pressure angle 20°)			Dimensions							Mounting-hole of outer ring				Mounting-hole of inner ring						Roller PCD	Basic static axial load rating C_{0a} (kN)	Gear specifications		(Refer.) Mass (kg)
					D_o	Module	No. of tooth	b	h_a	h_i	o	O_a	O_i	U_a	L_a	n_a	d_a	t_a	L_i	n_i	d_i	t_i	d_{i1}	t_{i1}			Addendum modification coefficient	Induction hardened tooth flanks and bottoms	
DTR2060TAGS	1	2 688	2 060	260	2 656	16	166	160	230	245	30	2 340	2 395	2 610	2 550	60	φ30	—	2 120	60	φ30	155	M27	50	2 310	31 100	—	○	3 780
DTR2150TAGS	1	2 830	2 150	300	2 800	20	140	180	240	285	60	2 480	2 540	2 730	2 650	48	φ39	—	2 235	48	φ39	178	M36	70	2 445	39 500	0.25	○	4 670
DTR2045TAGS	1	2 880	2 045	310	2 840	20	142	225	275	300	35	2 375	2 567	2 774	2 700	44	φ42	—	2 125	40	φ42	195	M39	70	2 420	79 700	—	○	6 320
DTR2020ATAG	1	2 950	2 020	400	2 900	25	116	270	355	375	45	2 420	2 550	2 825	2 720	64	φ48	—	2 120	48	φ48	265	M45	70	2 430	53 100	—	○	8 700
DTR2350TAGS-1	1	3 030	2 350	295	3 000	20	150	180	235	280	60	2 649	2 745	2 930	2 860	48	φ39	—	2 425	48	φ39	197	M36	83	2 645	47 700	0.25	○	4 980
DTR2510CTAGS	1	3 256	2 510	335	3 212	22	146	225	295	310	40	2 860	2 902	3 134	3 060	52	φ48	—	2 590	42	φ48	197	M45	70	2 820	50 700	—	○	6 660
DTR2475TAGS-1	1	3 275	2 475	355	3 225	25	129	270	315	345	40	2 850	2 905	3 134	3 060	52	φ48	—	2 555	42	φ48	225	M45	70	2 813	56 700	—	○	7 800
DTR2475TAGS-2	1	3 328	2 475	380	3 264	32	102	295	340	345	40	2 850	2 905	3 134	3 060	52	φ48	—	2 555	42	φ48	225	M45	70	2 813	56 700	—	○	8 570
DTR2735TAGS	1	3 490	2 735	350	3 460	20	173	190	290	335	60	3 087	3 185	3 390	3 315	64	φ39	—	2 810	64	φ39	215	M36	70	3 062	62 600	0.25	○	7 700
DTR2760TAGS-1	1	3 636	2 760	415	3 600	24	150	240	335	400	80	3 150	3 305	3 515	3 440	80	φ39	—	2 845	80	φ39	282	M36	75	3 155	81 500	0.25	○	10 900
DTR2870TAGS-8	1	3 696	2 870	365	3 648	24	152	290	325	350	40	3 240	3 305	3 534	3 460	72	φ48	—	2 960	60	φ48	248	M45	65	3 205	66 100	—	○	9 390
DTR2990TAG-1	2	3 740	2 990	350	3 696	22	168	190	295	335	60	3 410	3 470	3 630	3 535	48	M48	80	3 085	48	φ52	228	M48	107	3 365	60 500	—	○	8 380
DTR3460TAGS	1 ¹⁾	3 984	3 460	245	3 920	14	280	190	215	245	30	3 722	3 735	3 865	3 815	48	φ33	—	3 515	48	φ33	140	M30	50	3 663	40 600	—	○	4 350
DTR3400TAGS	1	4 250	3 400	365	4 200	25	168	290	325	350	40	3 770	3 873	4 120	4 030	100	φ48	—	3 490	80	φ48	248	M45	65	3 745	84 600	—	○	11 300
DTR3330TAGS-3	1	4 268	3 330	435	4 224	22	192	290	395	415	40	3 810	3 893	4 140	4 050	100	φ48	—	3 420	80	φ48	287	M45	85	3 745	99 600	—	○	14 800
DTR3205TAGS-1	1	4 464	3 205	550	4 416	24	184	400	500	480	50	3 650	4 042	4 340	4 230	100	φ62	—	3 295	80	φ48	320	M45	85	3 755	200 000	—	○	25 600
DTR3450TAG	1	4 500	3 450	540	4 450	25	178	250	460	520	80	3 990	4 083	4 350	4 265	108	φ48	—	3 540	91	φ48	360	M45×3 110	3 905	128 000	—	○	21 000	
DTR3600TAGS-1	1	4 550	3 600	435	4 500	25	180	300	390	415	45	4 080	4 163	4 410	4 320	100	φ48	—	3 690	80	φ48	287	M45	85	4 015	107 000	—	○	16 100

[Note] 1) Without oil seals.

Slewing rim bearings for tunnel-boring machine

DTR...T type (With external gear)

D_a 4 851 ~ 7 200 mm

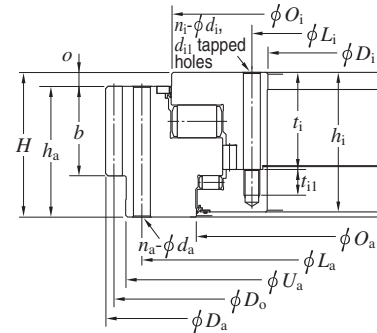

Design 1

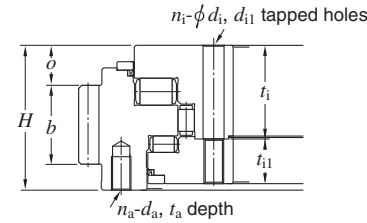

Design 2

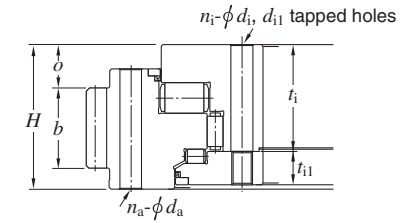

Design 3

Bearing No.	De-sign	Outside dia. D_a	Bore dia. D_i	Height H	Gear data (pressure angle 20°)			Dimensions							Mounting-hole of outer ring				Mounting-hole of inner ring						Roller PCD	Basic static axial load rating C_{0a} (kN)	Gear specifications		(Refer.) Mass (kg)
					D_o	Module	No. of tooth	b	h_a	h_i	o	O_a	O_i	U_a	Qty. L_a	n_a	d_a	t_a	Qty. L_i	n_i	d_i	t_i	d_{i1}	t_{i1}			Addendum modification coefficient	Induction hardened tooth flanks and bottoms	
DTR3915TAGS	1	4 851	3 915	420	4 818	22	219	260	350	405	70	4 327	4 480	4 735	4 640	120	$\phi 45$	—	4 010	96	$\phi 48$	282	M45	75	4 330	113 000	0.25	○	16 500
DTR4075TAGS	1	4 851	4 075	365	4 818	22	219	260	295	345	70	4 440	4 538	4 740	4 650	96	$\phi 45$	—	4 160	96	$\phi 45$	225	M42	80	4 415	92 100	0.25	○	11 800
DTR4210TAG-2	3	5 202.4	4 210	400	5 152	28	184	224	335	390	119	4 710	4 780	5 070	4 950	60	$\phi 60$	—	4 330	72	$\phi 60$	297	M56	93	4 652	114 000	—	○	17 500
DTR4555ATAGS	1	5 500	4 555	420	5 456	22	248	260	380	405	40	4 975	5 117	5 385	5 290	120	$\phi 48$	—	4 650	96	$\phi 48$	282	M45	75	4 970	131 000	—	○	19 400
DTR4600TAG	1	5 544	4 600	420	5 500	22	250	260	380	405	40	5 075	5 160	5 430	5 335	96	$\phi 48$	—	4 695	96	$\phi 48$	282	M45	75	5 020	123 000	—	○	19 700
DTR4510TAG-1	1	5 550	4 510	440	5 500	25	220	320	390	430	50	5 035	5 140	5 420	5 310	100	$\phi 60$	—	4 620	100	$\phi 60$	300	M56	85	4 993	135 000	—	○	22 200
DTR5850TAG	1	7 200	5 850	535	7 140	30	238	300	455	515	80	6 415	6 713	7 045	6 930	120	$\phi 62$	—	5 960	120	$\phi 62$	375	M56	85	6 475	345 000	—	○	46 000

Slewing rim bearings for tunnel-boring machine

SP/DTR...T type (Splitted race and with external gear)

D_a 2 950 ~ 7 140 mm

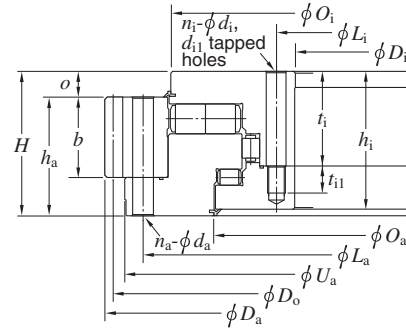

Design 1 (quarter split type)

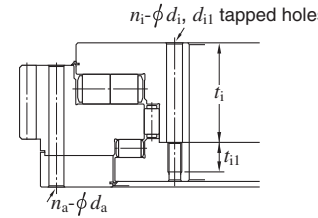

Design 2 (double split type)

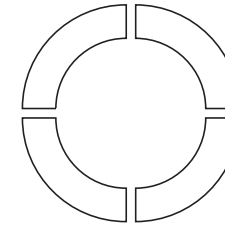

quarter split type

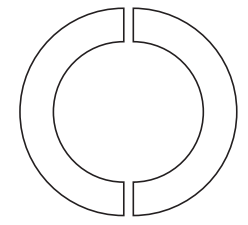

double split type

Bearing No.	De-sign	Outside dia. D_a	Bore dia. D_i	Height H	Gear data (pressure angle 20°)			Dimensions							Mounting-hole of outer ring			Mounting-hole of inner ring					Roller PCD	Basic static axial load rating C_{0a} (kN)	Gear specifications Induction hardened tooth flanks and bottoms	(Refer.) Mass (kg)	
					D_o	Module	No. of tooth	b	h_a	h_i	o	O_a	O_i	U_a	L_a	Qty.	n_a	d_a	L_i	Qty.	n_i	d_i					t_i
SP/DTR2020ATAG	1	2 950	2 020	400	2 900	25	116	270	355	375	45	2 420	2 550	2 825	2 720	64	φ50	2 120	48	φ50	265	M45	70	2 430	47 200	○	8 700
SP/DTR4430TAG	1	5 550	4 430	410	5 500	25	220	250	360	390	50	4 925	5 140	5 420	5 310	80	φ62	4 550	80	φ62	280	M56	110	4 955	159 000	○	22 300
SP/DTR4860TAG	1	6 050	4 860	450	6 000	25	240	250	370	430	80	5 370	5 640	5 920	5 810	80	φ62	4 980	80	φ62	295	M56	85	5 420	222 000	○	28 000
SP/DTR5060TAG	1	6 250	5 060	450	6 200	25	248	250	370	430	80	5 570	5 840	6 120	6 010	80	φ62	5 180	80	φ62	295	M56	85	5 620	232 000	○	29 100
SP/DTR5060TAG-2	1	6 250	5 060	450	6 200	25	248	285	405	430	45	5 570	5 840	6 120	6 010	80	φ62	5 180	72	φ62	300	M56	85	5 620	232 000	○	30 000
SP/DTR5060TAG-1	1	6 300	5 060	450	6 240	30	208	250	370	430	80	5 570	5 840	6 120	6 010	96	φ62	5 180	72	φ62	300	M56	85	5 620	232 000	○	29 700
SP/DTR5790TAG	1	7 140	5 790	535	7 080	30	236	300	455	515	80	6 340	6 685	6 985	6 870	120	φ62	5 900	96	φ62	235	M56	85	6 415	319 000	○	45 600

Slewing rim bearings for tunnel-boring machine

2TR...type (with internal gear)

D_a 2 580 ~ 3 800 mm

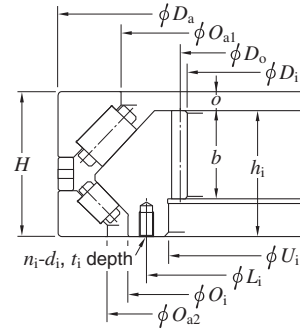

Design 1

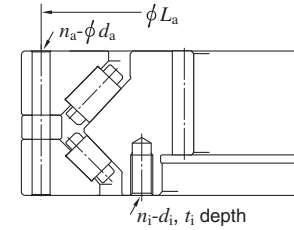

Design 2

Bearing No.	De-sign	Outside dia. D_a	Bore dia. D_i	Outer ring width H	Gear data (pressure angle 20°)			Dimensions							Mounting-hole of outer ring			Mounting-hole of inner ring				Basic static axial load rating C_{0a} (kN)	Gear specifications Induction hardened tooth flanks and bottoms	(Refer.) Mass (kg)
					D_o	Module	No. of tooth	b	h_i	o	O_{a1}	O_{a2}	O_i	U_i	L_a	Qty. n_a	d_a	L_i	Qty. n_i	d_i	t_i			
2TR2048-1CS	1	2 580	2 048	320	2 080	16	130	160	260	60	2 320	2 385	2 310	2 140	—	—	—	2 230	48	M30×3	50	13 600	○	3 530
2TR2376CS	2	2 800	2 376	180	2 400	12	200	130	180	—	2 582	2 605	2 550	2 450	2 750	84	$\phi 23.5$	2 500	84	M27	50	7 200	○	1 920
2TR2448-1CS	1	2 980	2 448	330	2 480	16	155	160	265	65	2 710	2 770	2 700	2 540	—	—	—	2 630	60	M30×3	50	15 200	○	4 240
2TR2450CS	1	2 980	2 464	330	2 492	14	178	160	265	65	2 710	2 770	2 700	2 540	—	—	—	2 630	60	M30×3	50	15 200	○	4 200
2TR3000ACS	2	3 500	2 996	210	3 024	14	216	160	210	-10	3 256	3 266	3 210	3 070	3 455	96	$\phi 23$	3 140	96	M33×3	50	10 000	○	3 300
2TR3180-1CS	1	3 797	3 180	330	3 220	20	161	220	285	45	3 516	3 580	3 488	3 305	—	—	—	3 405	96	M36×3	60	20 300	○	6 390
2TR3216CS	1	3 800	3 216	330	3 248	16	203	200	285	45	3 516	3 580	3 488	3 305	—	—	—	3 405	96	M33×3	55	20 300	○	6 200

Spherical roller bearing for wind turbine generator main shaft

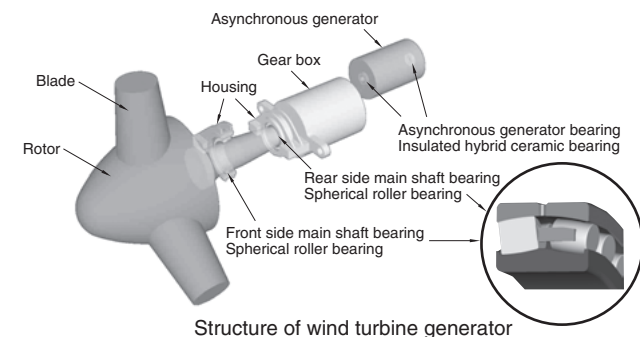
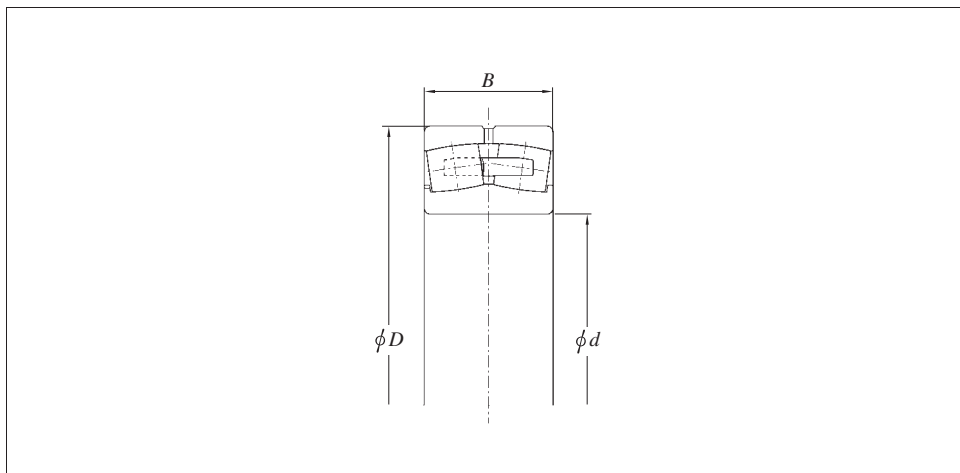

Structure of wind turbine generator

Features of spherical roller bearing for wind turbine generator main shaft

- The bearing, featuring superior radial load rating, can accommodate radial load and axial load in both directions.
- Optimization of raceway profile allows stable rotation performance.
- It absorbs misalignment in mounting and deflection. (Allowable aligning angle : 1° or more)

Bearing No.	Boundary dimensions (mm)			Bearing No.	Boundary dimensions (mm)			Bearing No.	Boundary dimensions (mm)		
	<i>d</i>	<i>D</i>	<i>B</i>		<i>d</i>	<i>D</i>	<i>B</i>		<i>d</i>	<i>D</i>	<i>B</i>
24156	280	460	180	24188	440	720	280	240/630	630	920	290
23060	300	460	118	24096	480	700	218	240/710	710	1 030	315
23160	300	500	160	230/530	530	780	185	230/750	750	1 090	250
23064	320	480	121	230/560	560	820	195	230/850	850	1 220	272
24064	320	480	160	240/600	600	870	272	240/900	900	1 280	375
23188	440	720	226	230/630	630	920	212	240/950	950	1 360	412

Back-up roll units for hot leveler

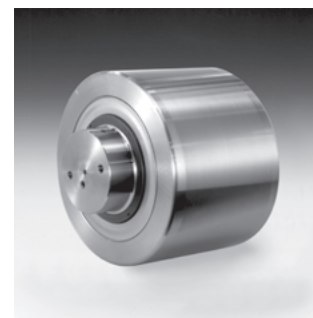
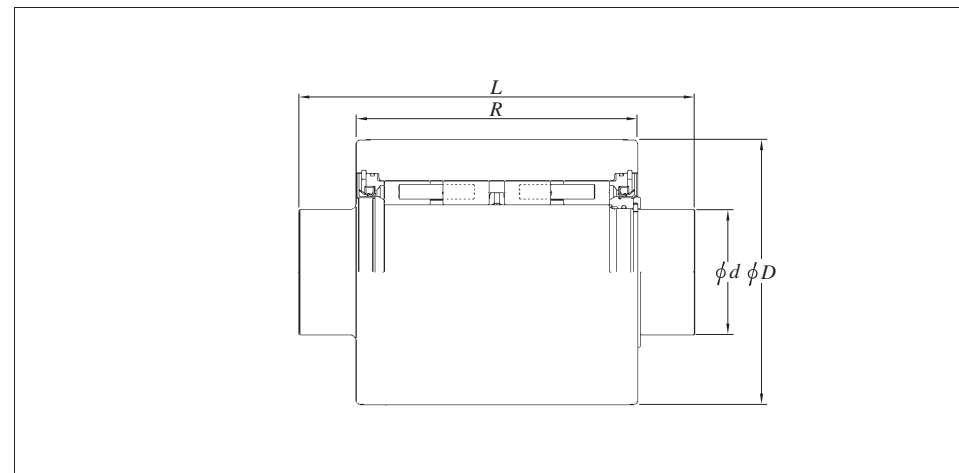

Boundary dimensions (mm)				Bearing No.	Basic load ratings (kN)		Mass (kg)
<i>D</i>	<i>d</i>	<i>R</i>	<i>L</i>		<i>C_r</i>	<i>C_{0r}</i>	
190	75	191	280	RM783C	591	964	42
200	90	230	310	RM962A	830	1 590	55
255	120	300	410	RM876B	1 440	2 890	120
310	130	370	480	RM1004	2 200	4 450	209
320	150	277	380	RM782H	1 760	3 340	171
412	180	295	420	RM736D	2 810	5 540	309
442	185	320	460	RM821C	2 910	5 350	374

Back-up roll units for tension leveler

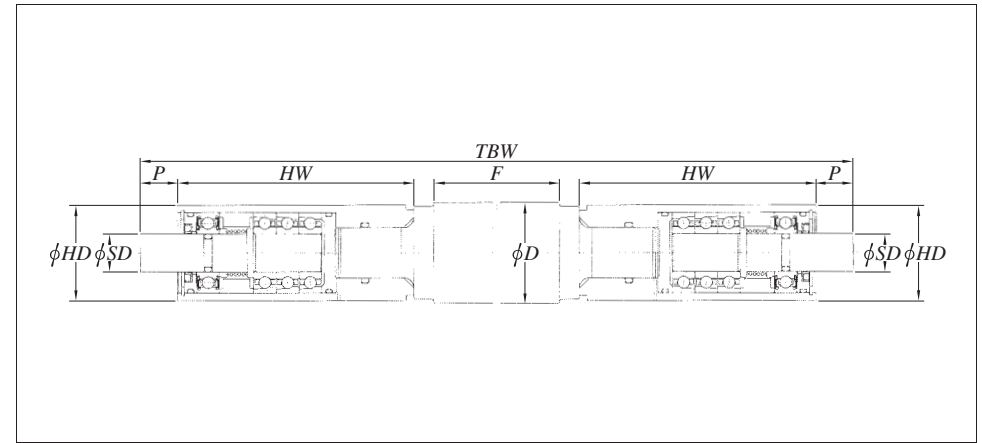
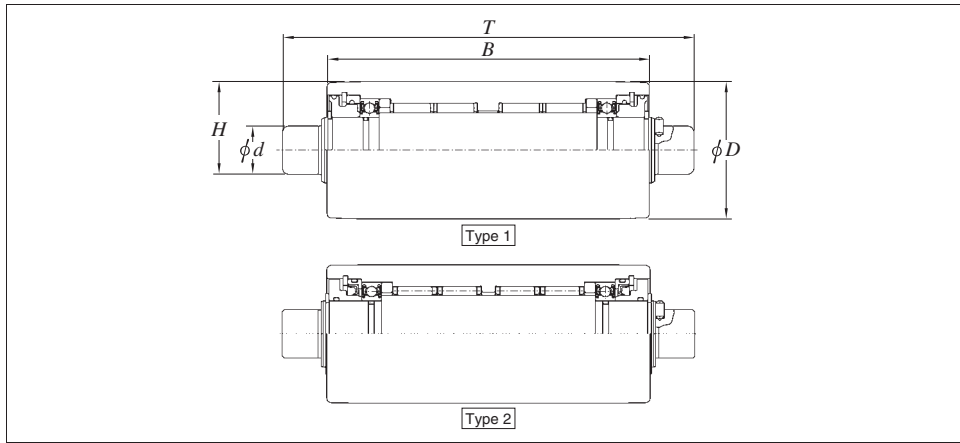

Boundary dimensions (mm)					Bearing No.	Basic load ratings (kN)		Types
D	B	d	T	H		C _r	C _{0r}	
47	115	20	145	33.5	TLW47115	58.5	113	2
50	80	24	106	37	TLD50080	42	70.5	1
	115	20	153	35	TLD50115	75.8	120	1
	180	20	218	35	TLD50180	75.8	120	1
51	150	22	191	36.5	TLD51150	75.8	120	1
	240	22	281	36.5	TLD51240	75.8	120	1
53	128	24	178	38.5	TLW53128	53.3	122	2
	218	24	268	38.5	TLW53218	53.3	122	2
63	163	22.2	204	42.5	TLD63163	92.6	187	1
	240	22	281	42.5	TLW63240	92.6	187	2
	275	22.2	316	42.5	TLD63275	92.6	187	1
	352	22	393	42.5	TLW63352	92.6	187	2
Boundary dimensions (mm)								
D	B	d	T	H	Bearing No.	Basic load ratings (kN)		Types
65	155	24	205	44.5	TLW65155A	92.6	187	2
	204	24	243	44.5	TLD65204	92.6	187	1
	258	24	308	44.5	TLW65258A	92.6	187	2
	275	24	314	44.5	TLD65275	92.6	187	1
75	155	30	205	52.5	TLW75155E	147	253	2
	170	30	215	52.5	TLD75170A	147	253	1
	258	30	308	52.5	TLW75258E	147	253	2
	265	30	310	52.5	TLD75265A	147	253	1
90	170	31	218	60.5	TLW90170	149	227	2
	280	31	328	60.5	TLW90280	149	227	2
130	285	69.5	348	99.75	TLW130285E	154	349	2
	450	69.5	513	99.75	TLW130450E	154	349	2

Boundary dimensions (mm)							Bearing No.	Mass (kg)
D	F	SD	HW	P	TBW	HD		
30	1 250	8	92	10	1 466	26	WTL301250S08B	7.5
	1 500	8	92	10	1 716	26	WTL301500S08A	8.9
38	1 250	12	70	10	1 410	29	WTL381250AS12F	11.5
	1 500	12	92	10	1 716	32	WTL381500S12	14.2
40	1 250	12	80	10	1 482	29	WTL401250AS12E	13.1
	1 500	12	92	10	1 716	32	WTL401500AS12D-1	15.6
46	1 900	15	94	14.75	2 133.5	38	WTL461900S15	26.0
50	1 250	12	92	10	1 466	32	WTL501250S12D	20.2
	1 500	12	92	10	1 716	32	WTL501500AS12D-1	23.3
52	1 900	15	94	14.75	2 133.5	38	WTL521900S15B-1	32.5
60	1 250	12	80	10	1 482	29	WTL601250S12E	28.6
	1 500	25	110	15	1 810	56	WTL601500S25	36.5
	1 900	15	94	14.75	2 133.5	38	WTL601900S15B-1	43.0
80	1 250	12	92	10	1 466	32	WTL801250S12D	49.7
	1 500	12	92	10	1 716	32	WTL801500S12D-1	58.8
100	1 250	12	92	10	1 466	32	WTL1001250S12D	77.1
	1 500	12	92	10	1 716	32	WTL1001500S12	92.3

Ladder bearing for converter

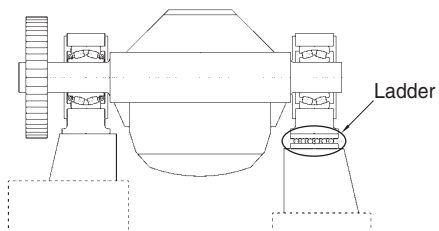
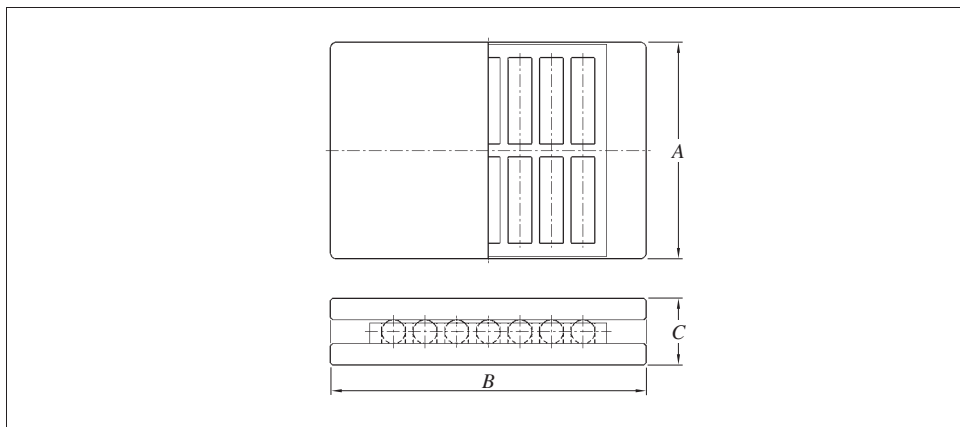

Ladder bearings smoothly absorb (let off) thermal expansion of the trunnion ring during operation.

Boundary dimensions (mm)			Bearing No.	Basic static load rating (kN) C _{0r}	Converter capacity (ton)
A	B	C			
83	340	90	THP83X340B	2 570	60
280	420	95	THP280X420	11 800	200
300	400	80	THP300X400B	6 690	150
400	400	85	THP400X400	14 900	200

Trunnion split bearing for converter

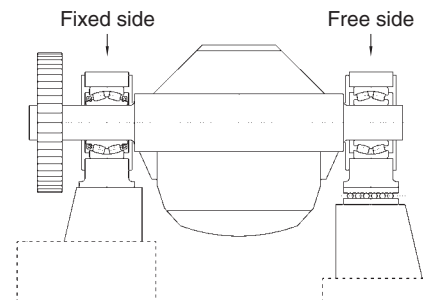

In integral type bearings, if they are required to be replaced at fixed side, all the tilting units surrounding the bearings must be removed, and exceedingly major replacement work has been required.

Use of split bearing enables easy handling of bearings and easy maintenance in the future.

Boundary dimensions (mm)				Bearing No.	Basic load ratings (kN)		Converter capacity (ton)
Bore diameter	Outside diameter	Inner ring width	Outer ring width		C _r	C _{0r}	
420	620	150	94	SP/92532W33CC3	2 130	4 060	160
750	1 090	395	250	SP/SR750W33-1C3	7 950	18 200	—
1 250	1 750	610	390	SP/SR1250W33-1C3	18 800	48 100	—
1 396	1 700	168+10	90	SP/SC1400CS780	2 780	8 620	—

Sealed bearing for sintered equipment

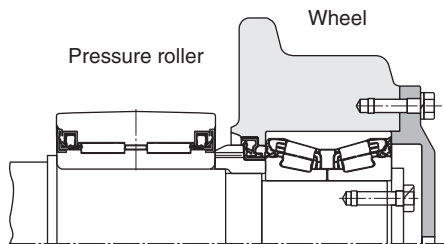
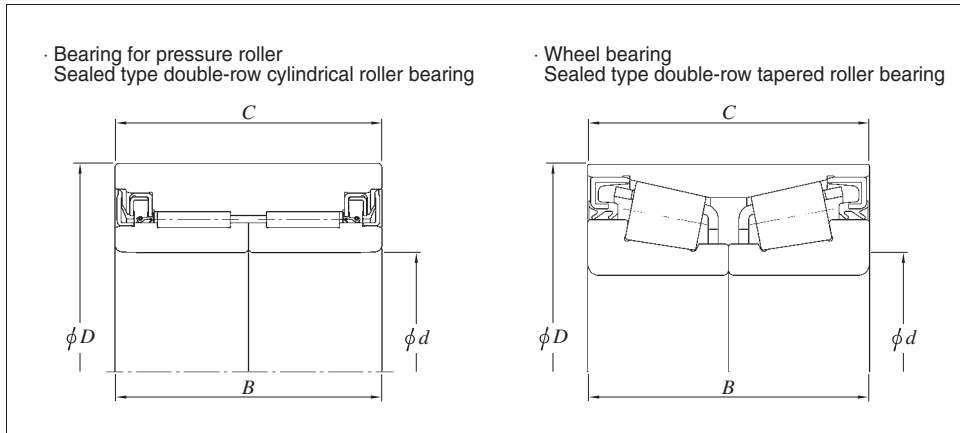

Bearing for pressure roller

- Special seals are provided on both sides to prevent ingress of sintered dusts.
- Special heat resistant grease withstanding high temperature and long use is adopted.
- High load rating full complement type.
- Thickness is optimized to secure strength of outer ring.
- Internal clearance of bearing is optimized.

Wheel bearing

- The seal mechanism prevents ingress of foreign matters into bearings.
- Special heat resistant grease withstanding high temperature and long use is adopted.
- Crowning is optimized to accommodate heavy load.
- Internal clearance of bearing is optimized.
- Bearing with the inner ring having locating snap ring to improve retrofitting performance is also available.

Bearing for pressure roller

Boundary dimensions (mm)				Bearing No.	Basic load ratings (kN)	
d	D	B	C		C _r	C _{0r}
120	210	132	132	24DCS21132V	449	1 400
130	210	150	150	26DCS21150V	540	1 830
160	250	140	140	32DCS25140BV	922	2 120

Wheel bearing

Boundary dimensions (mm)				Bearing No.	Basic load ratings (kN)	
d	D	B	C		C _r	C _{0r}
90	160	78	78	46T181608A-1RS-1	350	522
100	180	100	100	46T201810RS-5	443	676
110	200	90	90	46T222009BRS	477	704

Spherical roller bearings for shaker screens

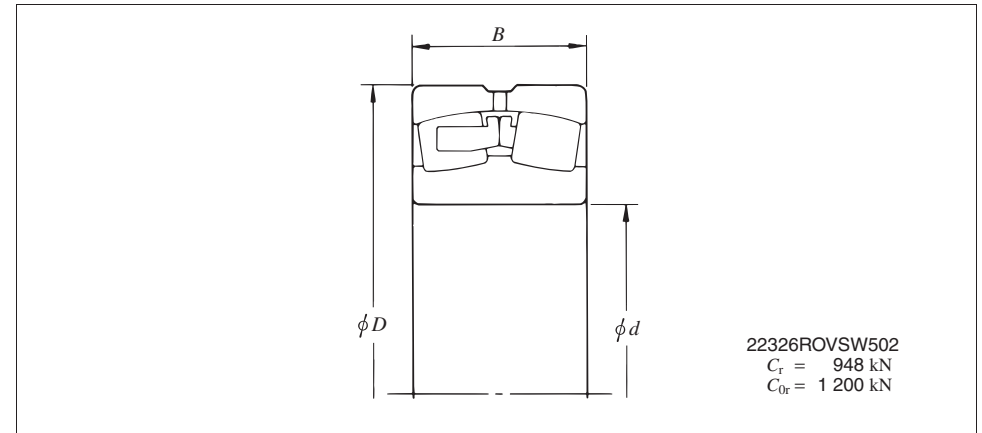

Features of the bearings for shaker screens

- (1) Considering lubricant flow under vibration and lubricating status of sliding surface, outer ring guided cage in special profile is used.
- (2) The cage is made of high-tensile brass casting for sufficient strength and resistance to wear.
- (3) While the bearing is rotated, peripheral speed difference occurs to the double row rollers. To prevent damages to cage including wear and breakage, separate and non-incorporated, prong type machined cage is used.
- (4) For smooth rolling motion of rollers, asymmetrical rollers having cone center are adopted.
- (5) Especially, bearing outside diameter tolerance is held to a small allowable variation.
- (6) C3 or C4 bearing internal clearance is used.

Bearing No.	Boundary dimensions (mm)		
	d	D	B
22320RROVSW502	100	215	73
22322RROVSW502	110	240	80
22324RROVSW502	120	260	86
22326RROVSW502	130	280	93
22328ROVSW502	140	300	102
22330ROVSW502	150	320	108

Bearing No.	Boundary dimensions (mm)		
	d	D	B
22332ROVSW502	160	340	114
22334ROVSW502	170	360	120
22336ROVSW502	180	380	126
22338ROVSW502	190	400	132
22340ROVSW502	200	420	138

• Bearing number of spherical roller bearings (mainly 223 series) should be followed by "R (RR) OVS W502".

Regrinding jigs for bearings for backing shafts

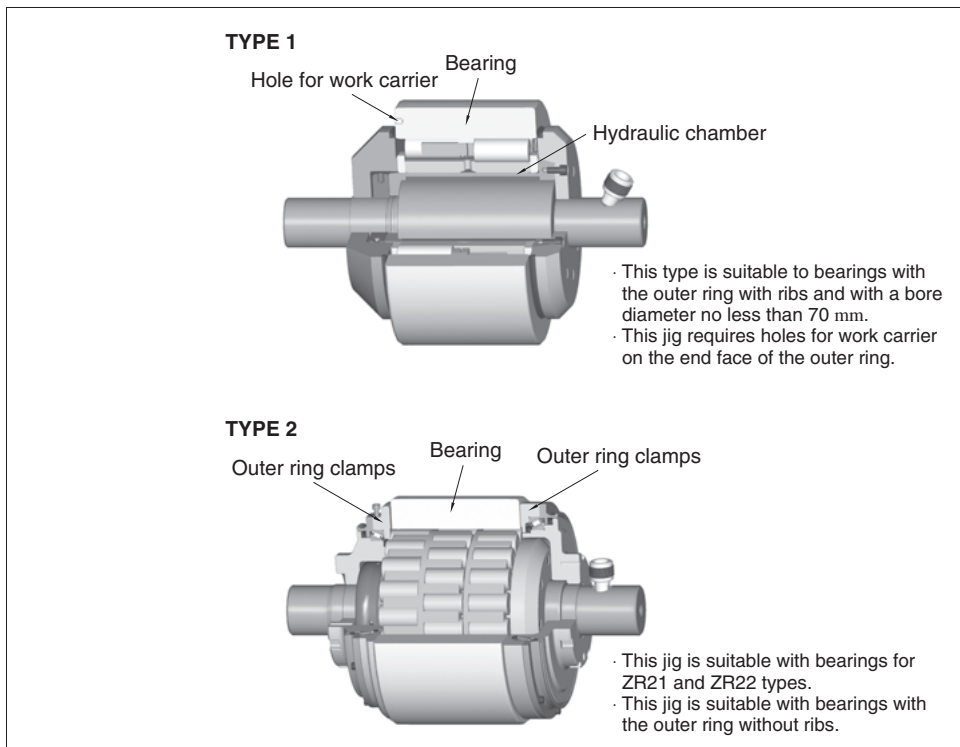

- The regrinding jig grinds the outside surfaces of bearings used on the backing shafts of multi-roll mills with high precision.
- The jig hydraulically grinds the outside surface while turning the outer ring and retaining the inner ring stationary, while it completely nullifies any clearance on the fitting surface between the jig and bearing and the internal clearance of the bearing, minimizing radial runout.
- The jig grinds bearing assemblies without need of disassembly, causing improvement in workability of installation and removal.

Oil / air lubricator for steel making and rolling equipment

- High sealing performance Elimination of ingress of foreign matters by pressure in chock (housing)
- High reliability of lubrication Superior lubricating performance by using oil of high viscosity and synthetic oil
- Clean working environment Clean environment by recovering oil

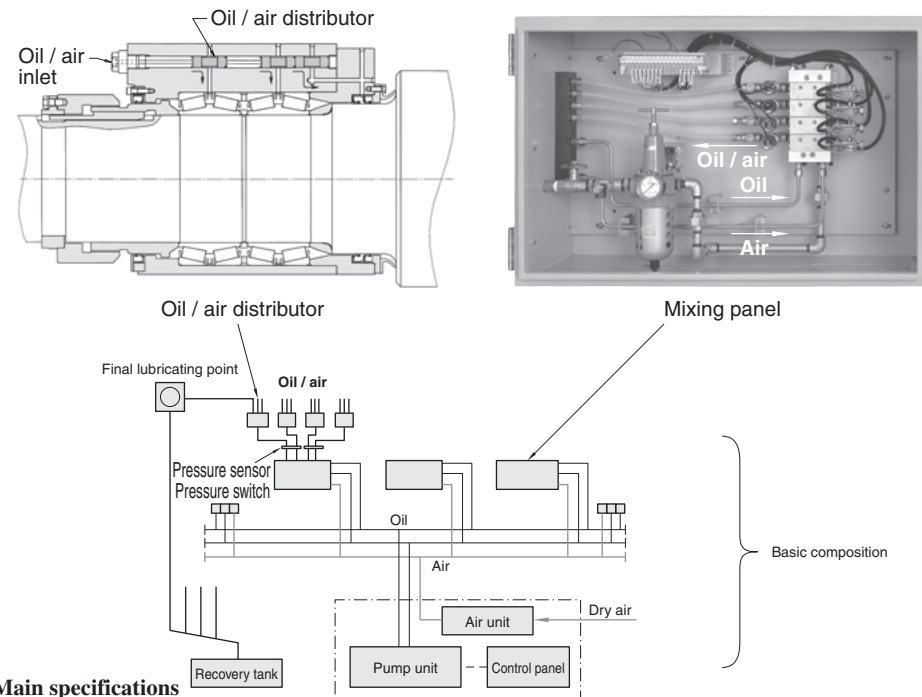

Main specifications

Lubricated object	Rolling mill roll neck bearing Rolling mill auxiliary roll bearing Continuous casting machine guide roll bearing Feed roll bearing, etc.
Tank capacity	From 250 to 2 000 ℓ
Number of lubricating points	1 000 points or more are available
Alarm unit	Respective sections in main unit End of oil and air piping
Lubricated oil q'ty	$Q = 0.085 \cdot d \cdot R/A$ Q : Lubricated oil q'ty cm ³ /hour d : Bearing bore diameter mm R : Bearing row number A : Speed coefficient (normally A = 5)

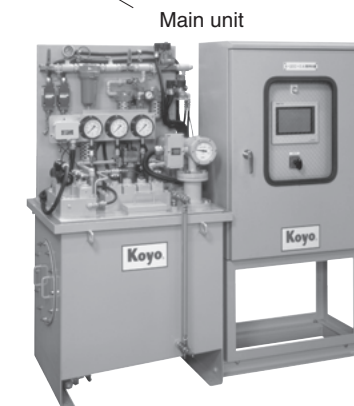

Supplementary table 1 (1) SI units and conversion factors

Mass	SI units	Other units ¹⁾	Conversion into SI units	Conversion from SI units
Angle	rad [radian(s)]	° [degree(s)] ' [minute(s)] " [second(s)]	* 1° = π /180 rad * 1' = π /10 800 rad * 1" = π /648 000 rad	1 rad = 57.295 78°
Length	m [meter(s)]	Å [Angstrom unit] μ [micron(s)] in [inch(es)] ft [foot(feet)] yd [yard(s)] mile [mile(s)]	1 Å = 10 ⁻¹⁰ m = 0.1 nm = 100 pm 1 μ = 1 μm 1 in = 25.4 mm 1 ft = 12 in = 0.304 8 m 1 yd = 3 ft = 0.914 4 m 1 mile = 5 280 ft = 1 609.344 m	1 m = 10 ¹⁰ Å 1 m = 39.37 in 1 m = 3.280 8 ft 1 m = 1.093 6 yd 1 km = 0.621 4 mile
Area	m ²	a [are(s)] ha [hectare(s)] acre [acre(s)]	1 a = 100 m ² 1 ha = 10 ⁴ m ² 1 acre = 4 840 yd ² = 4 046.86 m ²	1 km ² = 247.1 acre
Volume	m ³	ℓ, L [liter(s)] cc [cubic centimeters] gal(US) [gallon(s)] floz(US) [fluid ounce(s)] barrel(US) [barrels(US)]	* 1 ℓ = 1 dm ³ = 10 ⁻³ m ³ 1 cc = 1 cm ³ = 10 ⁻⁶ m ³ 1 gal(US) = 231 in ³ = 3.785 41 dm ³ 1 floz(US) = 29.573 5 cm ³ 1 barrel(US) = 158.987 dm ³	1 m ³ = 10 ³ ℓ 1 m ³ = 10 ⁶ cc 1 m ³ = 264.17 gal 1 m ³ = 33 814 floz 1 m ³ = 6.289 8 barrel
Time	s [second(s)]	min [minute(s)] h [hour(s)] d [day(s)]	* * *	
Angular velocity	rad/s			
Velocity	m/s	kn [knot(s)] m/h	* 1 kn = 1 852 m/h	1 km/h = 0.539 96 kn
Acceleration	m/s ²	G	1 G = 9.806 65 m/s ²	1 m/s ² = 0.101 97 G
Frequency	Hz [hertz]	c/s [cycle(s)/second]	1 c/s = 1 s ⁻¹ = 1 Hz	
Rotational frequency	s ⁻¹	rpm [revolutions per minute] min ⁻¹ r/min	* 1 rpm = 1 / 60 s ⁻¹	1 s ⁻¹ = 60 rpm
Mass	kg [kilogram(s)]	t [ton(s)] lb [pound(s)] gr [grain(s)] oz [ounce(s)] ton (UK) [ton(s)(UK)] ton (US) [ton(s)(US)] car [carat(s)]	* 1 t = 10 ³ kg 1 lb = 0.453 592 37 kg 1 gr = 64.798 91 mg 1 oz = 1/16 lb = 28.349 5 g 1 ton (UK) = 1 016.05 kg 1 ton (US) = 907.185 kg 1 car = 200 mg	1 kg = 2.204 6 lb 1 g = 15.432 4 gr 1 kg = 35.274 0 oz 1 t = 0.984 2 ton (UK) 1 t = 1.102 3 ton (US) 1 g = 5 car

[Note] * : Unit can be used as an SI unit.
No asterisk : Unit cannot be used.

Supplementary table 1 (2) SI units and conversion factors

Mass	SI units	Other units ¹⁾	Conversion into SI units	Conversion from SI units
Density	kg/m ³			
Linear density	kg/m			
Momentum	kg·m/s			
Moment of momentum, angular momentum	} kg·m ² /s			
Moment of inertia				
Force	N [newton(s)]	dyn [dyne(s)] kgf [kilogram-force] gf [gram-force] tf [ton-force] lbf [pound-force]	1 dyn = 10 ⁻⁵ N 1 kgf = 9.806 65 N 1 gf = 9.806 65×10 ⁻³ N 1 tf = 9.806 65×10 ³ N 1 lbf = 4.448 22 N	1 N = 10 ⁵ dyn 1 N = 0.101 97 kgf 1 N = 0.224 809 lbf
Moment of force	N·m [Newton meter(s)]	gf·cm kgf·cm kgf·m tf·m lbf·ft	1 gf·cm = 9.806 65×10 ⁻⁵ N·m 1 kgf·cm = 9.806 65×10 ⁻² N·m 1 kgf·m = 9.806 65 N·m 1 tf·m = 9.806 65×10 ³ N·m 1 lbf·ft = 1.355 82 N·m	1 N·m = 0.101 97 kgf·m 1 N·m = 0.737 56 lbf·ft
Pressure, Normal stress	Pa [Pascal(s)] or N/m ² {1 Pa = 1 N/m ² }	gf/cm ² kgf/mm ² kgf/m ² lbf/in ² bar [bar(s)] at [engineering air pressure] mH ₂ O, mAq [meter water column] atm [atmosphere] mHg [meter mercury column] Torr [torr]	1 gf/cm ² = 9.806 65×10 Pa 1 kgf/mm ² = 9.806 65×10 ⁶ Pa 1 kgf/m ² = 9.806 65 Pa 1 lbf/in ² = 6 894.76 Pa 1 bar = 10 ⁵ Pa 1 at = 1 kgf/cm ² = 9.806 65×10 ⁴ Pa 1 mH ₂ O = 9.806 65×10 ³ Pa 1 atm = 101 325 Pa 1 mHg = $\frac{101\ 325}{0.76}$ Pa 1 Torr = 1 mmHg = 133.322 Pa	1 MPa = 0.101 97 kgf/mm ² 1 Pa = 0.101 97 kgf/m ² 1 Pa = 0.145×10 ⁻³ lbf/in ² 1 Pa = 10 ⁻² mbar 1 Pa = 7.500 6×10 ⁻³ Torr
Viscosity	Pa·s [pascal second]	P [poise] kgf·s/m ²	10 ⁻² P = 1 cP = 1 mPa·s 1 kgf·s/m ² = 9.806 65 Pa·s	1 Pa·s = 0.101 97 kgf·s/m ²
Kinematic viscosity	m ² /s	St [stokes]	10 ⁻² St = 1 cSt = 1 mm ² /s	
Surface tension	N/m			

Supplementary table 1 (3) SI units and conversion factors

Mass	SI units	Other units ¹⁾	Conversion into SI units	Conversion from SI units
Work, energy	J [joule(s)] {1 J=1 N·m}	eV [electron volt(s)] * erg [erg(s)] kgf·m lbf·ft	1 eV = (1.602 189 2± 0.000 004 6)×10 ⁻¹⁹ J 1 erg = 10 ⁻⁷ J 1 kgf·m = 9.806 65 J 1 lbf·ft = 1.355 82 J	1 J = 10 ⁷ erg 1 J = 0.101 97 kgf·m 1 J = 0.737 56 lbf·ft
Power	W [watt(s)]	erg / s [ergs per second] kgf·m / s PS [French horse-power] HP [horse-power (British)] lbf·ft / s	1 erg / s = 10 ⁻⁷ W 1 kgf·m / s = 9.806 65 W 1 PS = 75 kgf·m / s = 735.5 W 1 HP = 550 lbf·ft / s = 745.7 W 1 lbf·ft / s = 1.355 82 W	1 W = 0.101 97 kgf·m / s 1 W = 0.001 36 PS 1 W = 0.001 34 HP
Thermo-dynamic temperature	K [kelvin(s)]			
Celsius temperature	°C [Celsius(s)] {t °C = (t + 273.15) K}	°F [degree(s) Fahrenheit]	t °F = $\frac{5}{9}(t - 32)$ °C	t °C = $(\frac{9}{5}t + 32)$ °F
Linear expansion coefficient	K ⁻¹	°C ⁻¹ [per degree]		
Heat	J [joule(s)] {1 J=1 N·m}	erg [erg(s)] kgf·m calIT [I. T. calories]	1 erg = 10 ⁻⁷ J 1 calIT = 4.186 8 J 1 McalIT = 1.163 kW·h	1 J = 10 ⁷ erg 1 J = 0.238 85 calIT 1 kW·h = 0.86 × 10 ⁶ calIT
Thermal conductivity	W / (m·K)	W / (m·°C) cal / (s·m·°C)	1 W / (m·°C) = 1 W / (m·K) 1 cal / (s·m·°C) = 4.186 05 W / (m·K)	
Coefficient of heat transfer	W / (m ² ·K)	W / (m ² ·°C) cal / (s·m ² ·°C)	1 W / (m ² ·°C) = 1 W / (m ² ·K) 1 cal / (s·m ² ·°C) = 4.186 05 W / (m ² ·K)	
Heat capacity	J/K	J / °C	1 J / °C = 1 J / K	
Massic heat capacity	J / (kg·K)	J / (kg·°C)		

[Note] * : Unit can be used as an SI unit.
No asterisk : Unit cannot be used.

Supplementary table 2 Inch/millimeter conversion

Inch	Inches										
	0	1	2	3	4	5	6	7	8	9	10
	mm										
0	0	0	0	0	0	0	0	0	0	0	0
1/64	0.015625	0.3969	25.4000	50.8000	76.2000	101.6000	127.0000	152.4000	177.8000	203.2000	228.6000
1/32	0.03125	0.7938	26.1938	51.5938	76.9938	102.3938	127.7938	153.1938	178.5938	203.9938	229.3938
3/64	0.046875	1.1906	26.5906	51.9906	77.3906	102.7906	128.1906	153.5906	178.9906	204.3906	229.7906
1/16	0.0625	1.5875	26.9875	52.3875	77.7875	103.1875	128.5875	153.9875	179.3875	204.7875	230.1875
5/64	0.078125	1.9844	27.3844	52.7844	78.1844	103.5844	128.9844	154.3844	179.7844	205.1844	230.5844
3/32	0.09375	2.3812	27.7812	53.1812	78.5812	103.9812	129.3812	154.7812	180.1812	205.5812	230.9812
7/64	0.109375	2.7781	28.1781	53.5781	78.9781	104.3781	129.7781	155.1781	180.5781	205.9781	231.3781
1/8	0.125	3.1750	28.5750	53.9750	79.3750	104.7750	130.1750	155.5750	180.9750	206.3750	231.7750
9/64	0.140625	3.5719	28.9719	54.3719	79.7719	105.1719	130.5719	155.9719	181.3719	206.7719	232.1719
5/32	0.15625	3.9688	29.3688	54.7688	80.1688	105.5688	130.9688	156.3688	181.7688	207.1688	232.5688
11/64	0.171875	4.3656	29.7656	55.1656	80.5656	105.9656	131.3656	156.7656	182.1656	207.5656	232.9656
3/16	0.1875	4.7625	30.1625	55.5625	80.9625	106.3625	131.7625	157.1625	182.5625	207.9625	233.3625
13/64	0.203125	5.1594	30.5594	55.9594	81.3594	106.7594	132.1594	157.5594	182.9594	208.3594	233.7594
7/32	0.21875	5.5562	30.9562	56.3562	81.7562	107.1562	132.5562	157.9562	183.3562	208.7562	234.1562
15/64	0.234375	5.9531	31.3531	56.7531	82.1531	107.5531	132.9531	158.3531	183.7531	209.1531	234.5531
1/4	0.25	6.3500	31.7500	57.1500	82.5500	107.9500	133.3500	158.7500	184.1500	209.5500	234.9500
17/64	0.265625	6.7469	32.1469	57.5469	82.9469	108.3469	133.7469	159.1469	184.5469	209.9469	235.3469
9/32	0.28125	7.1438	32.5438	57.9438	83.3438	108.7438	134.1438	159.5438	184.9438	210.3438	235.7438
19/64	0.296875	7.5406	32.9406	58.3406	83.7406	109.1406	134.5406	159.9406	185.3406	210.7406	236.1406
5/16	0.3125	7.9375	33.3375	58.7375	84.1375	109.5375	134.9375	160.3375	185.7375	211.1375	236.5375
21/64	0.328125	8.3344	33.7344	59.1344	84.5344	109.9344	135.3344	160.7344	186.1344	211.5344	236.9344
11/32	0.34375	8.7312	34.1312	59.5312	84.9312	110.3312	135.7312	161.1312	186.5312	211.9312	237.3312
23/64	0.359375	9.1281	34.5281	59.9281	85.3281	110.7281	136.1281	161.5281	186.9281	212.3281	237.7281
3/8	0.375	9.5250	34.9250	60.3250	85.7250	111.1250	136.5250	161.9250	187.3250	212.7250	238.1250
25/64	0.390625	9.9219	35.3219	60.7219	86.1219	111.5219	136.9219	162.3219	187.7219	213.1219	238.5219
13/32	0.40625	10.3188	35.7188	61.1188	86.5188	111.9188	137.3188	162.7188	188.1188	213.5188	238.9188
27/64	0.421875	10.7156	36.1156	61.5156	86.9156	112.3156	137.7156	163.1156	188.5156	213.9156	239.3156
7/16	0.4375	11.1125	36.5125	61.9125	87.3125	112.7125	138.1125	163.5125	188.9125	214.3125	239.7125
29/64	0.453125	11.5094	36.9094	62.3094	87.7094	113.1094	138.5094	163.9094	189.3094	214.7094	240.1094
15/32	0.46875	11.9062	37.3062	62.7062	88.1062	113.5062	138.9062	164.3062	189.7062	215.1062	240.5062
31/64	0.484375	12.3031	37.7031	63.1031	88.5031	113.9031	139.3031	164.7031	190.1031	215.5031	240.9031
1/2	0.5	12.7000	38.1000	63.5000	88.9000	114.3000	139.7000	165.1000	190.5000	215.9000	241.3000
33/64	0.515625	13.0969	38.4969	63.8969	89.2969	114.6969	140.0969	165.4969	190.8969	216.2969	241.6969
17/32	0.53125	13.4938	38.8938	64.2938	89.6938	115.0938	140.4938	165.8938	191.2938	216.6938	242.0938
35/64	0.546875	13.8906	39.2906	64.6906	90.0906	115.4906	140.8906	166.2906	191.6906	217.0906	242.4906
9/16	0.5625	14.2875	39.6875	65.0875	90.4875	115.8875	141.2875	166.6875	192.0875	217.4875	242.8875
37/64	0.578125	14.6844	40.0844	65.4844	90.8844	116.2844	141.6844	167.0844	192.4844	217.8844	243.2844
19/32	0.59375	15.0812	40.4812	65.8812	91.2812	116.6812	142.0812	167.4812	192.8812	218.2812	243.6812
39/64	0.609375	15.4781	40.8781	66.2781	91.6781	117.0781	142.4781	167.8781	193.2781	218.6781	244.0781
5/8	0.625	15.8750	41.2750	66.6750	92.0750	117.4750	142.8750	168.2750	193.6750	219.0750	244.4750
41/64	0.640625	16.2719	41.6719	67.0719	92.4719	117.8719	143.2719	168.6719	194.0719	219.4719	244.8719
21/32	0.65625	16.6688	42.0688	67.4688	92.8688	118.2688	143.6688	169.0688	194.4688	219.8688	245.2688
43/64	0.671875	17.0656	42.4656	67.8656	93.2656	118.6656	144.0656	169.4656	194.8656	220.2656	245.6656
11/16	0.6875	17.4625	42.8625	68.2625	93.6625	119.0625	144.4625	169.8625	195.2625	220.6625	246.0625
45/64	0.703125	17.8594	43.2594	68.6594	94.0594	119.4594	144.8594	170.2594	195.6594	221.0594	246.4594
23/32	0.71875	18.2562	43.6562	69.0562	94.4562	119.8562	145.2562	170.6562	196.0562	221.4562	246.8562
47/64	0.734375	18.6531	44.0531	69.4531	94.8531	120.2531	145.6531	171.0531	196.4531	221.8531	247.2531
3/4	0.75	19.0500	44.4500	69.8500	95.2500	120.6500	146.0500	171.4500	196.8500	222.2500	247.6500
49/64	0.765625	19.4469	44.8469	70.2469	95.6469	121.0469	146.4469	171.8469	197.2469	222.6469	248.0469
25/32	0.78125	19.8438	45.2438	70.6438	96.0438	121.4438	146.8438	172.2438	197.6438	223.0438	248.4438
51/64	0.796875	20.2406	45.6406	71.0406	96.4406	121.8406	147.2406	172.6406	198.0406	223.4406	248.8406
13/16	0.8125	20.6375	46.0375	71.4375	96.8375	122.2375	147.6375	173.0375	198.4375	223.8375	249.2375
53/64	0.828125	21.0344	46.4344	71.8344	97.2344	122.6344	148.0344	173.4344	198.8344	224.2344	249.6344
27/32	0.84375	21.4312	46.8312	72.2312	97.6312	123.0312	148.4312	173.8312	199.2312	224.6312	250.0312
55/64	0.859375	21.8281	47.2281	72.6281	98.0281	123.4281	148.8281	174.2281	199.6281	225.0281	250.4281
7/8	0.875	22.2250	47.6250	73.0250	98.4250	123.8250	149.2250	174.6250	200.0250	225.4250	250.8250
57/64	0.890625	22.6219	48.0219	73.4219	98.8219	124.2219	149.6219	175.0219	200.4219	225.8219	251.2219
29/32	0.90625	23.0188	48.4188	73.8188	99.2188	124.6188	150.0188	175.4188	200.8188	226.2188	251.6188
59/64	0.921875	23.4156	48.8156	74.2156	99.6156	125.0156	150.4156	175.8156	201.2156	226.6156	252.0156
15/16	0.9375	23.8125	49.2125	74.6125	100.0125	125.4125	150.8125	176.2125	201.6125	227.0125	252.4125
61/64	0.953125	24.2094	49.6094	75.0094	100.4094	125.8094	151.2094	176.6094	202.0094	227.4094	252.8094
31/32	0.96875	24.6062	50.0062	75.4062	100.8062	126.2062	151.6062	177.0062	202.4062	227.8062	253.2062
63/64	0.984375	25.0031	50.4031	75.8031	101.2031	126.6031	152.0031	177.4031	202.8031	228.2031	253.6031

Supplementary table 3 Steel hardness conversion

Rockwell C-scale 1 471.0 N (150 kgf)	Vicker's	Brinell		Rockwell		Shore
		Standard ball	Tungsten carbide ball	A-scale 588.4 N (60 kgf)	B-scale 980.7 N (100 kgf)	
68	940			85.6		97
67	900			85.0		95
66	865			84.5		92
65	832		739	83.9		91
64	800		722	83.4		88
63	772		705	82.8		87
62	746		688	82.3		85
61	720		670	81.8		83
60	697		654	81.2		81
59	674		634	80.7		80
58	653		615	80.1		78
57	633		595	79.6		76
56	613		577	79.0		75
55	595	-	560	78.5		74
54	577	-	543	78.0		72
53	560	-	525	77.4		71
52	544	500	512	76.8		69
51	528	487	496	76.3		68
50	513	475	481	75.9		67
49	498	464	469	75.2		66
48	484	451	455	74.7		64
47	471	442	443	74.1		63
46	458	432	432	73.6		62
45	446		421	73.1		60
44	434		409	72.5		58
43	423		400	72.0		57
42	412		390	71.5		56
41	402		381	70.9		55
40	392		371	70.4	-	54
39	382		362	69.9	-	52
38	372		353	69.4	-	51
37	363		344	68.9	-	50
36	354		336	68.4	(109.0)	49
35	345		327	67.9	(108.5)	48
34	336		319	67.4	(108.0)	47
33	327		311	66.8	(107.5)	46
32	318		301	66.3	(107.0)	44
31	310		294	65.8	(106.0)	43
30	302		286	65.3	(105.5)	42
29	294		279	64.7	(104.5)	41
28	286		271	64.3	(104.0)	41
27	279		264	63.8	(103.0)	40
26	272		258	63.3	(102.5)	38
25	266		253	62.8	(101.5)	38
24	260		247	62.4	(101.0)	37
23	254		243	62.0	100.0	36
22	248		237	61.5	99.0	35
21	243		231	61.0	98.5	35
20	238		226	60.5	97.8	34
(18)	230		219	-	96.7	33
(16)	222		212	-	95.5	32
(14)	213		203	-	93.9	31
(12)	204		194	-	92.3	29
(10)	196		187		90.7	28
(8)	188		179		89.5	27
(6)	180		171		87.1	26
(4)	173		165		85.5	25
(2)	166		158		83.5	24
(0)	160		152		81.7	24

Supplementary table 4 Viscosity conversion

Kinematic viscosity mm ² /s	Saybolt SUS (second)		Redwood R (second)		Engler E (degree)
	100 °F	210 °F	50 °C	100 °C	
2	32.6	32.8	30.8	31.2	1.14
3	36.0	36.3	33.3	33.7	1.22
4	39.1	39.4	35.9	36.5	1.31
5	42.3	42.6	38.5	39.1	1.40
6	45.5	45.8	41.1	41.7	1.48
7	48.7	49.0	43.7	44.3	1.56
8	52.0	52.4	46.3	47.0	1.65
9	55.4	55.8	49.1	50.0	1.75
10	58.8	59.2	52.1	52.9	1.84
11	62.3	62.7	55.1	56.0	1.93
12	65.9	66.4	58.2	59.1	2.02
13	69.6	70.1	61.4	62.3	2.12
14	73.4	73.9	64.7	65.6	2.22
15	77.2	77.7	68.0	69.1	2.32
16	81.1	81.7	71.5	72.6	2.43
17	85.1	85.7	75.0	76.1	2.54
18	89.2	89.8	78.6	79.7	2.64
19	93.3	94.0	82.1	83.6	2.76
20	97.5	98.2	85.8	87.4	2.87
21	102	102	89.5	91.3	2.98
22	106	107	93.3	95.1	3.10
23	110	111	97.1	98.9	3.22
24	115	115	101	103	3.34
25	119	120	105	107	3.46
26	123	124	109	111	3.58
27	128	129	112	115	3.70
28	132	133	116	119	3.82
29	137	138	120	123	3.95
30	141	142	124	127	4.07
31	145	146	128	131	4.20
32	150	150	132	135	4.32
33	154	155	136	139	4.45
34	159	160	140	143	4.57
35	163	164	144	147	4.70
36	168	170	148	151	4.83
37	172	173	153	155	4.96
38	177	178	156	159	5.08
39	181	183	160	164	5.21
40	186	187	164	168	5.34
41	190	192	168	172	5.47
42	195	196	172	176	5.59
43	199	201	176	180	5.72
44	204	205	180	185	5.85
45	208	210	184	189	5.98
46	213	215	188	193	6.11
47	218	219	193	197	6.24
48	222	224	197	202	6.37
49	227	228	201	206	6.50
50	231	233	205	210	6.63
55	254	256	225	231	7.24
60	277	279	245	252	7.90
65	300	302	266	273	8.55
70	323	326	286	294	9.21
75	346	349	306	315	9.89
80	371	373	326	336	10.5
85	394	397	347	357	11.2
90	417	420	367	378	11.8
95	440	443	387	399	12.5
100	464	467	408	420	13.2
120	556	560	490	504	15.8
140	649	653	571	588	18.4
160	742	747	653	672	21.1
180	834	840	734	757	23.7
200	927	933	816	841	26.3
250	1 159	1 167	1 020	1 051	32.9
300	1 391	1 400	1 224	1 241	39.5

[Remark] 1 mm²/s = 1 cSt (centi stokes)

Supplementary table 5 Shaft tolerances (deviation from nominal dimensions)

Unit : μm (Refer.)

Nominal shaft dia. (mm)		Deviation classes of shaft dia.																				Nominal shaft dia. (mm)		$\Delta_{dmp}^{(1)}$ of bearing (class 0)										
over	up to	d 6	e 6	f 6	g 5	g 6	h 5	h 6	h 7	h 8	h 9	h 10	js 5	js 6	js 7	j 5	j 6	k 5	k 6	k 7	m 5	m 6	m 7		n 5	n 6	p 6	r 6	r 7	over	up to			
30	50	-80 -96	-50 -66	-25 -41	-9 -20	-9 -25	0 -11	0 -16	0 -25	0 -39	0 -62	0 -100	± 5.5	± 8	± 12.5	+6 -5	+11 -5	+13 +2	+18 +2	+27 +2	+20 +9	+25 +9	+34 +9	+28 +17	+33 +17	+42 +26	+50 +34	+59 +34	30	50	0 -12			
50	80	-100 -119	-60 -79	-30 -49	-10 -23	-10 -29	0 -13	0 -19	0 -30	0 -46	0 -74	0 -120	± 6.5	± 9.5	± 15	+6 -7	+12 -7	+15 +2	+21 +2	+32 +2	+24 +11	+30 +11	+41 +11	+33 +20	+39 +20	+51 +32	+60 +41	+71 +41	50	65	0 -15			
80	120	-120 -142	-72 -94	-36 -58	-12 -27	-12 -34	0 -15	0 -22	0 -35	0 -54	0 -87	0 -140	± 7.5	± 11	± 17.5	+6 -9	+13 -9	+18 +3	+25 +3	+38 +3	+28 +13	+35 +13	+48 +13	+38 +23	+45 +23	+59 +37	+73 +51	+86 +51	80	100	0 -20			
120	180	-145 -170	-85 -110	-43 -68	-14 -32	-14 -39	0 -18	0 -25	0 -40	0 -63	0 -100	0 -160	± 9	± 12.5	± 20	+7 -11	+14 -11	+21 +3	+28 +3	+43 +3	+33 +15	+40 +15	+55 +15	+45 +27	+52 +27	+68 +43	+88 +63	+103 +63	120	140	0 -25			
180	250	-170 -199	-100 -129	-50 -79	-15 -35	-15 -44	0 -20	0 -29	0 -46	0 -72	0 -115	0 -185	± 10	± 14.5	± 23	+7 -13	+16 -13	+24 +4	+33 +4	+50 +4	+37 +17	+46 +17	+63 +17	+51 +31	+60 +31	+79 +50	+106 +77	+123 +77	180	200	0 -30			
250	315	-190 -222	-110 -142	-56 -88	-17 -40	-17 -49	0 -23	0 -32	0 -52	0 -81	0 -130	0 -210	± 11.5	± 16	± 26	+7 -16	+16 -16	+27 +4	+36 +4	+56 +4	+43 +20	+52 +20	+72 +20	+57 +34	+66 +34	+88 +56	+126 +94	+146 +94	250	280	0 -35			
315	400	-210 -246	-125 -161	-62 -98	-18 -43	-18 -54	0 -25	0 -36	0 -57	0 -89	0 -140	0 -230	± 12.5	± 18	± 28.5	+7 -18	+18 -18	+29 +4	+40 +4	+61 +4	+46 +21	+57 +21	+78 +21	+62 +37	+73 +37	+98 +62	+144 +108	+165 +108	315	355	0 -40			
400	500	-230 -270	-135 -175	-68 -108	-20 -47	-20 -60	0 -27	0 -40	0 -63	0 -97	0 -155	0 -250	± 13.5	± 20	± 31.5	+7 -20	+20 -20	+32 +5	+45 +5	+68 +5	+50 +23	+63 +23	+86 +23	+67 +40	+80 +40	+108 +68	+166 +126	+189 +126	400	450	0 -45			
500	630	-260 -304	-145 -189	-76 -120	-22 -54	-22 -66	0 -32	0 -44	0 -70	0 -110	0 -175	0 -280	± 16	± 22	± 35	-	-	+32 0	+44 0	+70 0	+58 +26	+70 +26	+96 +26	+76 +44	+88 +44	+122 +78	+194 +150	+220 +150	500	560	0 -50			
630	800	-290 -340	-160 -210	-80 -130	-24 -60	-24 -74	0 -36	0 -50	0 -80	0 -125	0 -200	0 -320	± 18	± 25	± 40	-	-	+36 0	+50 0	+80 0	+66 +30	+80 +30	+110 +30	+86 +50	+100 +50	+138 +88	+225 +175	+255 +175	630	710	0 -75			
800	1000	-320 -376	-170 -226	-86 -142	-26 -66	-26 -82	0 -40	0 -56	0 -90	0 -140	0 -230	0 -360	± 20	± 28	± 45	-	-	+40 0	+56 0	+90 0	+74 +34	+90 +34	+124 +34	+96 +56	+112 +56	+156 +100	+266 +210	+300 +210	800	900	0 -100			
1000	1250	-350 -416	-195 -261	-98 -164	-28 -75	-28 -94	0 -47	0 -66	0 -105	0 -165	0 -260	0 -420	± 23.5	± 33	± 52.5	-	-	+47 0	+66 0	+105 0	+87 +40	+106 +40	+145 +40	+113 +66	+132 +66	+186 +120	+316 +250	+355 +250	1000	1120	0 -125			
1250	1600	-390 -468	-220 -298	-110 -188	-30 -85	-30 -108	0 -55	0 -78	0 -125	0 -195	0 -310	0 -500	± 27.5	± 39	± 62.5	-	-	+55 0	+78 0	+125 0	+103 +48	+126 +48	+173 +48	+133 +78	+156 +78	+218 +140	+378 +300	+425 +300	1250	1400	0 -160			
1600	2000	-430 -522	-240 -332	-120 -212	-32 -97	-32 -124	0 -65	0 -92	0 -150	0 -230	0 -370	0 -600	± 32.5	± 46	± 75	-	-	+65 0	+92 0	+150 0	+123 +58	+150 +58	+208 +58	+157 +92	+184 +92	+262 +170	+462 +370	+520 +370	1600	1800	0 -200			

[Note] 1) Δ_{dmp} : single plane mean bore diameter deviation

Supplementary table 6 Housing bore tolerances (deviation from nominal dimensions)

Unit : μm (Refer.)

Nominal Bore dia. (mm)		Deviation classes of housing bore														Nominal Bore dia. (mm)		$\Delta D_{mp}^{(1)}$ of bearing (class 0)																						
over	up to	E 6	F 6	F 7	G 6	G 7	H 6	H 7	H 8	H 9	H 10	JS 5	JS 6	JS 7	J 6	J 7	K 5		K 6	K 7	M 5	M 6	M 7	N 5	N 6	N 7	P 6	P 7	R 7	over	up to									
50	80	+79	+49	+60	+29	+40	+19	+30	+46	+74	+120	± 6.5	± 9.5	± 15	+13	+18	+3	-10	+4	-15	+9	-21	-6	-19	-5	-24	0	-30	-15	-14	-9	-26	-21	-30	-21	-51	-30	50	65	0
		+60	+30	+30	+10	+10	0	0	0	0	0	0				-6																					-12	-32	-62	-38
80	120	+94	+58	+71	+34	+47	+22	+35	+54	+87	+140	± 7.5	± 11	± 17.5	+16	+22	+2	-13	+4	-18	+10	-25	-8	-23	-6	-28	0	-35	-18	-16	-10	-30	-24	-52	-59	-38	80	100	0	
		+72	+36	+36	+12	+12	0	0	0	0	0	0				-6																				-13	-41	-76	-73	-76
120	180	+110	+68	+83	+39	+54	+25	+40	+63	+100	+160	± 9	± 12.5	± 20	+18	+26	+3	-15	+4	-21	+12	-28	-9	-27	-8	-33	0	-40	-21	-20	-12	-36	-28	-68	-48	120	140	0		
		+85	+43	+43	+14	+14	0	0	0	0	0	0				-7																			-14	-50	-90	-90	-90	-53
180	250	+129	+79	+96	+44	+61	+29	+46	+72	+115	+185	± 10	± 14.5	± 23	+22	+30	+2	-18	+5	-24	+13	-33	-11	-31	-8	-37	0	-46	-25	-22	-14	-41	-33	-79	-60	180	200	0		
		+100	+50	+50	+15	+15	0	0	0	0	0	0				-7																			-16	-63	-109	-109	-109	-67
250	315	+142	+88	+108	+49	+69	+32	+52	+81	+130	+210	± 11.5	± 16	± 26	+25	+36	+3	-20	+5	-27	+16	-36	-13	-36	-9	-41	0	-52	-27	-25	-14	-47	-36	-88	-74	250	280	0		
		+110	+56	+56	+17	+17	0	0	0	0	0	0				-7																			-16	-78	-130	-130	-78	-113
315	400	+161	+98	+119	+54	+75	+36	+57	+89	+140	+230	± 12.5	± 18	± 28.5	+29	+39	+3	-22	+7	-29	+17	-40	-14	-39	-10	-46	0	-57	-30	-26	-16	-51	-41	-98	-87	315	355	0		
		+125	+62	+62	+18	+18	0	0	0	0	0	0				-7																			-18	-93	-150	-150	-93	-150
400	500	+175	+108	+131	+60	+83	+40	+63	+97	+155	+250	± 13.5	± 20	± 31.5	+33	+43	+2	-25	+8	-32	+18	-45	-16	-43	-10	-50	0	-63	-33	-27	-17	-55	-45	-108	-103	400	450	0		
		+135	+68	+68	+20	+20	0	0	0	0	0	0				-7																			-20	-166	-166	-109	-172	-103
500	630	+189	+120	+146	+66	+92	+44	+70	+110	+175	+280	± 16	± 22	± 35	-	-	0	-32	0	-44	0	-70	-26	-58	-26	-70	-26	-96	-44	-44	-114	-78	-78	-148	-150	500	560	0		
		+145	+76	+76	+22	+22	0	0	0	0	0	0				-																			-	-220	-225	-225	-225	-150
630	800	+210	+130	+160	+74	+104	+50	+80	+125	+200	+320	± 18	± 25	± 40	-	-	0	-36	0	-50	0	-80	-30	-66	-30	-80	-30	-110	-50	-50	-130	-88	-88	-168	-175	630	710	0		
		+160	+80	+80	+24	+24	0	0	0	0	0	0				-																			-	-255	-265	-265	-265	-175
800	1000	+226	+142	+176	+82	+116	+56	+90	+140	+230	+360	± 20	± 28	± 45	-	-	0	-40	0	-56	0	-90	-34	-74	-34	-90	-34	-124	-56	-56	-146	-100	-100	-190	-210	800	900	0		
		+170	+86	+86	+26	+26	0	0	0	0	0	0				-																			-	-300	-310	-310	-310	-210
1000	1250	+261	+164	+203	+94	+133	+66	+105	+165	+260	+420	± 23.5	± 33	± 52.5	-	-	0	-47	0	-66	0	-105	-40	-87	-40	-106	-40	-145	-66	-66	-171	-120	-120	-225	-250	1000	1120	0		
		+195	+98	+98	+28	+28	0	0	0	0	0	0				-																			-	-355	-365	-365	-365	-250
1250	1600	+298	+188	+235	+108	+155	+78	+125	+195	+310	+500	± 27.5	± 39	± 62.5	-	-	0	-55	0	-78	0	-125	-48	-103	-48	-126	-48	-173	-78	-78	-203	-140	-140	-265	-300	1250	1400	0		
		+220	+110	+110	+30	+30	0	0	0	0	0	0				-																			-	-425	-455	-455	-455	-300
1600	2000	+332	+212	+270	+124	+182	+92	+150	+230	+370	+600	± 32.5	± 46	± 75	-	-	0	-65	0	-92	0	-150	-58	-123	-58	-150	-58	-208	-92	-92	-242	-170	-170	-320	-370	1600	1800	0		
		+240	+120	+120	+32	+32	0	0	0	0	0	0				-																			-	-520	-550	-550	-550	-370
2000	2500	+370	+240	+305	+144	+209	+110	+175	+280	+440	+700	± 39	± 55	± 87.5	-	-	0	-78	0	-110	0	-175	-68	-146	-68	-178	-68	-243	-110	-110	-285	-195	-195	-370	-440	2000	2240	0		
		+260	+130	+130	+34	+34	0	0	0	0	0	0				-																			-	-615	-635	-635	-635	-440

[Note] 1) ΔD_{mp} : single plane mean outside diameter deviation

GLOBAL NETWORK

BEARING BUSINESS OPERATIONS

JTEKT CORPORATION NAGOYA HEAD OFFICE

No.7-1, Meieki 4-chome, Nakamura-ku, Nagoya, Aichi 450-8515, JAPAN
TEL : 81-52-527-1900
FAX : 81-52-527-1911

JTEKT CORPORATION OSAKA HEAD OFFICE

No.5-8, Minamisemba 3-chome, Chuo-ku, Osaka 542-8502, JAPAN
TEL : 81-6-6271-8451
FAX : 81-6-6245-3712

Sales & Marketing Headquarters

No.5-8, Minamisemba 3-chome, Chuo-ku, Osaka 542-8502, JAPAN
TEL : 81-6-6245-6087
FAX : 81-6-6244-9007

OFFICES

KOYO CANADA INC.

5324 South Service Road, Burlington, Ontario L7L 5H5, CANADA
TEL : 1-905-681-1121
FAX : 1-905-681-1392

JTEKT NORTH AMERICA CORPORATION

-Main Office-

47771 Halyard Drive, Plymouth, MI 48170, U.S.A.
TEL : 1-734-454-1500
FAX : 1-734-454-7059

-Cleveland Office-

29570 Clemens Road, P.O.Box 45028, Westlake, OH 44145, U.S.A.
TEL : 1-440-835-1000
FAX : 1-440-835-9347

KOYO MEXICANA, S.A. DE C.V.

Av. Insurgentes Sur 2376-505, Col. Chimalistac, Del. Álvaro Obregón, C.P. 01070, México, D.F.
TEL : 52-55-5207-3860
FAX : 52-55-5207-3873

KOYO LATIN AMERICA, S.A.

Edificio Banco del Pacífico Planta Baja, Calle Aquilino de la Guardia y Calle 52, Panama, REPUBLICA DE PANAMA
TEL : 507-208-5900
FAX : 507-264-2782/507-269-7578

KOYO ROLAMENTOS DO BRASIL LTDA.

Avenida Brigadeiro Faria Lima, 1744 - 1st Floor - C.J. 11 São Paulo - SP - Brazil CEP 01451-001
TEL : 55-11-3372-7500
FAX : 55-11-3887-3039

KOYO MIDDLE EAST FZCO

6EA 601, Dubai Airport Free Zone, P.O. Box 54816, Dubai, U.A.E.
TEL : 97-1-4299-3600
FAX : 97-1-4299-3700

KOYO BEARINGS INDIA PVT. LTD.

C/o Stylus Commercial Services PVT LTD, Ground Floor, The Beech, E-1, Manyata Embassy Business Park, Outer Ring Road, Bengaluru-560045, INDIA
TEL : 91-80-4276-4567 (Reception Desk of Service Office)
FAX : 91-80-4276-4568

JTEKT (THAILAND) CO., LTD.

172/1 Moo 12 Tambol Bangwua, Amphur Bangpakong, Chachoengsao 24180, THAILAND
TEL : 66-38-533-310-7
FAX : 66-38-532-776

PT. JTEKT INDONESIA

Jl. Surya Madya Plot I-27b, Kawasan Industri Surya Cipta, Kutanegara, Ciampel, Karawang Jawa Barat, 41363 Indonesia
TEL : 62-267-8610-270
FAX : 62-267-8610-271

KOYO SINGAPORE BEARING (PTE.) LTD.

27, Penjuru Lane, Level 5, Phase 1 Warehouse #05-01. SINGAPORE 609195
TEL : 65-6274-2200
FAX : 65-6862-1623

PHILIPPINE KOYO BEARING CORPORATION

6th Floor, One World Square Building, #10 Upper McKinley Road, McKinley Town Center Fort Bonifacio, 1634 Taguig City, PHILIPPINES
TEL : 63-2-856-5046/5047
FAX : 63-2-856-5045

JTEKT KOREA CO., LTD.

Seong-do Bldg 13F, 207, Dosan-Dearo, Gangnam-Gu, Seoul, KOREA
TEL : 82-2-549-7922
FAX : 82-2-549-7923

JTEKT (CHINA) CO., LTD.

Room.25A2, V-CAPITAL Building, 333 Xianxia Road, Changning District, Shanghai 200336, CHINA
TEL : 86-21-5178-1000
FAX : 86-21-5178-1008

KOYO AUSTRALIA PTY. LTD.

Unit 2, 8 Hill Road, Homebush Bay, NSW 2127, AUSTRALIA
TEL : 61-2-8719-5300
FAX : 61-2-8719-5333

JTEKT EUROPE BEARINGS B.V.

Markerkant 13-01, 1314 AL Almere, THE NETHERLANDS
TEL : 31-36-5383333
FAX : 31-36-5347212

-Benelux Branch Office-

Energieweg 10a, 2964 LE, Groot-Amers, THE NETHERLANDS
TEL : 31-184606800
FAX : 31-184606857

KOYO KULLAGER SCANDINAVIA A.B.

Johanneslundsvägen 4, 194 61 Uppvidas Väsby, SWEDEN
TEL : 46-8-594-212-10
FAX : 46-8-594-212-29

KOYO (U.K.) LIMITED

Whitehall Avenue, Kingston, Milton Keynes MK10 0AX, UNITED KINGDOM
TEL : 44-1908-289300
FAX : 44-1908-289333

KOYO DEUTSCHLAND GMBH

Bargkoppelweg 4, D-22145 Hamburg, GERMANY
TEL : 49-40-67-9090-0
FAX : 49-40-67-9203-0

KOYO FRANCE S.A.

6 avenue du Marais, BP20189, 95105 Argenteuil, FRANCE
TEL : 33-1-3998-4202
FAX : 33-1-3998-4244/4249

KOYO IBERICA, S.L.

Avda.de la Industria, 52-2 izda 28820 Coslada Madrid, SPAIN
TEL : 34-91-329-0818
FAX : 34-91-747-1194

KOYO ITALIA S.R.L.

Via Stephenson 43/a 20157 Milano, ITALY
TEL : 39-02-2951-0844
FAX : 39-02-2951-0954

-Romanian Representative Office-

24, Lister Street, ap. 1, sector 5, Bucharest, ROMANIA
TEL : 40-21-410-4182
FAX : 40-21-410-1178

BEARING PLANTS

KOYO BEARINGS CANADA INC.

4 Victoria Street, Bedford, Quebec JOJ-1A0, CANADA
TEL : 1-450-248-3316
FAX : 1-450-248-4196

KOYO BEARINGS NORTH AMERICA LLC

-Orangeburg Plant-

2850 Magnolia Street, Orangeburg, SC 29115, U.S.A.
TEL : 1-803-536-6200
FAX : 1-803-534-0599

-Richland Plant-

1006 Northpoint Blvd., Blythewood, SC 29016, U.S.A.
TEL : 1-803-691-4624/4633
FAX : 1-803-691-4655

-Washington Plant-

146 Cutting Edge Court Telford, TN 37690, U.S.A.
TEL : 1-423-913-1006
FAX : 1-423-913-1008

-Dahlonega Plant-

615 Torrington Drive Dahlonega, GA 30533, U.S.A.
TEL : 1-706-864-7691
FAX : 1-706-864-8258

-Cairo Plant-

2525 Torrington Drive, PO BOX 2449, Cairo, GA 39828, U.S.A.
TEL : 1-229-377-6650
FAX : 1-229-377-9760

-Sylvania Plant-

400 Friendship Road, Sylvania, GA 30467, U.S.A.
TEL : 1-912-564-7151
FAX : 1-912-564-2101

-Walhalla Plant-

1430 Torrington Road, Po Box 100, Walhalla, SC 29691, U.S.A.
TEL : 1-864-638-3683
FAX : 1-864-638-2434

JTEKT (THAILAND) CO., LTD.

172/1 Moo 12 Tambol Bangwua, Amphur Bangpakong, Chachoengsao 24180, THAILAND
TEL : 66-38-531-988-933
FAX : 66-38-531-996

KOYO MANUFACTURING (PHILIPPINES) CORP.

Lima Technology Center, Municipality of Malvar, Batangas Province 4233, PHILIPPINES
TEL : 63-43-981-0088
FAX : 63-43-981-0001

KOYO JICO KOREA CO., LTD.

464 Hyeongok-ri, Cheongbuk-myeon, Pyeongteak-city, Gyeonggi-do, KOREA
TEL : 82-31-612-0800
FAX : 82-31-612-0888

KOYO BEARING DALIAN CO., LTD.

No.II A-2 Dalian Export Processing Zone, Dalian City, Liaoning, CHINA
TEL : 86-411-8731-0972/0974
FAX : 86-411-8731-0973

WUXI KOYO BEARING CO., LTD.

No.30 Xiangge Road, Hudai Town, Binhu District, Wuxi, Jiangsu. 214161, P.R. CHINA
TEL : 86-510-8516-1901
FAX : 86-510-8516-1143

KOYO NEEDLE BEARINGS (WUXI) CO., LTD.

No.32 Xiangge Road, Hudai Town, Binhu District, Wuxi, Jiangsu. 214161, P.R. CHINA
TEL : 86-510-6878-9913
FAX : 86-510-6878-9687

DALIAN KOYO WAZHOU AUTOMOBILE BEARING CO., LTD.

No.96, Liaohe East Road, Dalian, D.D Port, CHINA
TEL : 86-411-8740-7272
FAX : 86-411-8740-7373

KOYO LIOHO (FOSHAN) AUTOMOTIVE PARTS CO., LTD.

No.12, Wusha Section Of Shunpan Road, Daliang Town, Shunde Of Foshan, Guangdong Province, CHINA (SHUNDE INDUSTRIAL PARK)
TEL : 86-757-22829589
FAX : 86-757-22829586

KOYO AUTOMOTIVE PARTS (WUXI) CO.,LTD.

B6-A Wuxi National Hi-Tech Industrial Development Zone, Wuxi, Jiangsu, CHINA
TEL : 86-510-8533-0909
FAX : 86-510-8533-0155

KOYO BEARINGS (EUROPE) LTD.

P.O.Box 101, Elmhirst Lane, Dodworth, Barnsley, South Yorkshire S75 3TA, UNITED KINGDOM
TEL : 44-1226-733200
FAX : 44-1226-204029

KOYO ROMANIA S.A.

Turmu Magurele Street No.1, 140003, ALEXANDRIA Teleorman County, ROMANIA
TEL : 40-247-31-2605
FAX : 40-247-31-5892

KOYO BEARINGS DEUTSCHLAND GMBH

Werkstrasse 5, D-33790 Halle (Westfalen), GERMANY
TEL : 49-5201-7070
FAX : 49-5201-707416

KOYO BEARINGS VIERZON MAROMME SAS

-Maromme Plant-

Zone Industrielle de LA-BP 1033, 7 Rue Ampere, Maromme, 76151, FRANCE
TEL : 33-23282-3838
FAX : 33-23576-6624

-Vierzon Plant-

61 Route de Feocyp-BP 238, Vierzon Cedex, 18102 FRANCE
TEL : 33-24852-6200
FAX : 33-24852-6250

KOYO BEARINGS MOULT SAS

Zone Industrielle de Moulit, 14370, FRANCE
TEL : 33-23127-9600
FAX : 33-23123-4693

KOYO BEARINGS ČESKÁ REPUBLIKA S.R.O.

Pavelkova 253/5, Bystrovany, Olomouc, 77900, CZECH REP
TEL : 42-585-126-501
FAX : 42-585-126-503

KOYO BEARINGS ESPAÑA S.A.

Doctor Diaz Empananza, 3, Bilbao, 48002, SPAIN
TEL : 34-94-4431400
FAX : 34-94-4440905

TECHNICAL CENTERS

JTEKT AUTOMOTIVE NORTH AMERICA INC.

TECHNICAL CENTER

47771 Halyard Drive, Plymouth, MI 48170, U.S.A.
TEL : 1-734-454-1500
FAX : 1-734-454-2759

KOYO BEARINGS NORTH AMERICA LLC

-PLYMOUTH TECHNICAL CENTER-

47771 Halyard Drive, Plymouth, MI 48170, U.S.A.
TEL : 1-734-454-1500
FAX : 1-734-454-4076

-GREENVILLE TECHNOLOGY CENTER-

7 Research Drive, Greenville, SC 29607, U.S.A.
TEL : 1-864-770-2100
FAX : 1-864-770-2399

JTEKT RESEARCH AND DEVELOPMENT CENTER

(WUXI) CO., LTD.

No.1082, Qianhu Road, Hudai Town, Binhu District, Wuxi, Jiangsu 214161, CHINA
TEL : 86-510-8589-8615
FAX : 86-510-8589-8698

JTEKT CORPORATION EUROPEAN TECHNICAL

CENTER

Markerkant 13-02, 1314 AL Almere, THE NETHERLANDS
TEL : 31-36-5383350
FAX : 31-36-5302656

KOYO BEARINGS DEUTSCHLAND GMBH

KUENSEBECK TECHNOLOGY CENTER

Werkstrasse 5, D-33790 Halle (Westfalen), GERMANY
TEL : 49-5201-7070
FAX : 49-5201-707416

KOYO BEARINGS ČESKÁ REPUBLIKA S.R.O.

BRNO TECHNOLOGY CENTER

Technologický Park Brno, Technická 15, 61600 Brno, 61600 CZECH REP
TEL : 420-541-191803
FAX : 420-541-191801

Koyo® LARGE SIZE BALL & ROLLER BEARINGS

Value & Technology



CAT. NO. B2002E-2
Printed in Japan '15.04-15BDS ('08.7)